

wavin Hep₂O OSMA



**Trade
Price List
Above Ground
Systems**

1st January 2025

www.wavin.co.uk

Pack quantity notice

Products which are supplied in pack multiples, but can also be ordered in singles are highlighted in a darker shade as follows:

Pack qty
5
5
5
5

Contents

	Page		Page
Introduction to Wavin Osma	2-3	Wavin Solvent Soil and Waste	60-69
Wavin Osma Rainwater	4-21	PVC-U Solvent Soil	60-65
RoundLine	4-8	Problem Solvers	66
SquareLine	9-13	PVC-C Solvent Weld waste	67-69
StormLine	14-15	Wavin HDPE	70-79
DeepLine	16-17	Soil, waste and vent	70-79
SuperLine	18-19	Introduction to Wavin Tigris	80
RoofLine	20-21	Wavin Tigris K5/M5	81-87
Wavin OsmaSoil	22-39	Wavin Tigris K1/M1	88-89
Soil and Vent PVC-U		Accessories and tools	90-91
Ring-seal system	22-30	Introduction to Wavin Hep₂O plumbing	92
Soil and Vent PVC-U		Wavin Hep₂O Push-fit plumbing	93-106
Solvent Weld system	31-35	Polybutylene pipe	93
WC connectors	36-37	Demountable fittings	94-97
WC connectors – Easy-fit	37	Flexible tap connectors – braided	98-99
Ancillaries	38-39	Auxiliary fittings	100-104
Wavin OsmaWeld	40-43	Tools, fixings and accessories	105-106
ABS Solvent Weld waste	40-43	Conduit system	106
Wavin Osma Waste	44-50	Introduction to Wavin Indoor Climate Solutions	107
PP Push-fit waste	44-46	Wavin Indoor Climate Solutions	108-119
Waste connectors and V-Joint traps	47-49	UFH – Comfia Packs	108
Condensate drainage	50	UFH – Polybutylene pipe	109
Wavin Osma Overflow	51-52	UFH – PE-RT 5 layer pipe	109
ABS / PVC-U Solvent Weld and PP Push-fit	51-52	UFH – Floor fixings and accessories	110
Wavin Osma Hep₂O	53	UFH – Manifolds	111-112
Hygienic self-sealing waste valves – Polypropylene	53	UFH – Panel Systems	113
Wavin Osma Problem Solvers	54	UFH – Control Systems	114-115
Flexible Waste pipe	54	UFH – Manifold Cabinets	116
Flexible soil pipe	54	UFH – Heat Interface Units	117
Condensate fitting	54	MVHR Units	118-119
Introduction to Wavin Industrial and Commercial systems	55	Numerical index	120-135
Wavin Industrial and Commercial systems	57-90	Important notes	136
Wavin AS+	57-59		
Acoustic Soil system – Astolan® and PVC-U	57-59		



All 110/160mm PVC-U soil pipe is manufactured using Wavin's Recycore Technology but has exactly the same performance and handling characteristics as virgin pipe.

Introduction to



Wavin Osma Above Ground Drainage includes a Guttering range with six profiles to choose from, OsmaSoil with push-fit and solvent weld connection options plus complimentary ancillaries, waste systems, traps (traditional and waterless) and overflow systems.

For information on the benefits and innovative features of the systems please see the Wavin Osma Rainwater and Wavin Osma Soil & Waste Product brochures.

Key to abbreviations

B	Black	E	Olive
N	Brown	W	White
G	Grey	AG	Anthracite Grey

P/E – Pipe and fittings with both ends plain or with one plain end and one special end.

S/S – Pipe and fittings with one or more ring-seal or push-fit sockets, but always one plain or special end.

D/S – Fittings with ring-seal or push-fit sockets at all ends.

S/SW – Fittings with one or more ring-seal sockets but always one solvent socket.

SW/S – Fittings with one or more solvent sockets and one plain or special end.

D/SW – Fittings with solvent sockets at all ends.

Symbols

British Standards Kitemark

Identifies pipe and fittings manufactured under the BSI Kitemark Certification Scheme.

British Board of Agrément

BBA Logo Identifies non-Kitemarked fittings covered by a British Board of Agrément Certificate.

WRAS Water Regulations Advisory Scheme

Identifies pipe and fittings that are WRAS approved.

Important notes:

All Wavin Osma Soil, Waste and Overflow fittings must be ordered in their pack multiples as illustrated in price list, unless the pack quantity is highlighted in a darker shade which indicates they can be ordered in singles.

Product photos are for example only and not representative of every fitting size.

Acceptance

a) British Standards Institution

♥ Wavin Osma Above Ground Drainage Systems comply, where applicable, with the requirements of the following British Standards:

BS 4576: Part 1: 1989 - Half-round gutters and pipes of circular cross section.

BS EN 1329-1: 2000, BS 4514: 2001 - Unplasticized PVC soil and ventilating pipes, fittings and accessories.

BS EN 1451-1: 2000 - Polypropylene waste pipe and fittings.

BS 5255: 1989 - Thermoplastics waste pipe and fittings.

BS EN 1566-1: 2000 – Plastic piping systems for soil and waste discharge (low and high temperature) within the building structure - Chlorinated poly (vinyl chloride) (PVC-C).

BS 6209: 1982 - Solvent cement for non pressure thermoplastics pipe systems.

BS EN 607: 2004 - Eaves, gutters and fittings made of PVC-U definitions, requirements and testing.

BS EN 1462: 2004 - Brackets for eaves gutters: requirements and testing.

BS EN 12200-1: 2000 - Plastics rainwater piping systems for above ground external use - unplasticized Poly Vinyl Chloride (PVC-U) - Part 1 specifications for pipes, fittings and the system.

BS EN 1455-1: 2000 - Plastic piping systems for soil and waste (low and high temperature) within the building structure - Acrylonitrile-butadiene-styrene (ABS).

BS EN 12380:2002 - Air admittance valves for drainage systems. Requirements, test methods and evaluation of conformity.

BS 5254:1976 - Specification for polypropylene waste pipe and fittings (external diameter 34.6 mm, 41.0 mm and 54.1 mm).

BS EN 1453-1:2000 - Plastics piping systems with structured-wall pipes for soil and waste discharge (low and high temperature) inside buildings. Unplasticized poly (vinyl chloride) (PVC-U). Specifications for pipes and the system.

b) British Board of Agrément

▲ The Wavin OsmaSoil system has been awarded the following certificates:

86/1643 OsmaVent 110 and OsmaVent 40 Air Admittance Valves.

89/2174 OsmaSoil 110mm Adjustable Bends.

c) WRAS

Wavin Hep₂O is approved (certificate 1901900) – deemed safe for use in the supply of drinking water.











The Silicone Lubricant Spray has WRAS approval for use with potable water.































All 110/160mm PVC-U soil pipe is manufactured using Wavin's Recycore Technology but has exactly the same performance and handling characteristics as virgin pipe.

Wavin Osma RoundLine







Rainwater half round domestic – PVC-U

Description	Nom dia mm	Cat no	Pack qty	Price £ per piece
Gutter				
 Gutter – 2.0m				
▽	112	OT072B	5	40.80
▽	112	OT072G	5	40.80
▽	112	OT072W	5	40.80
▽	112	OT072N	5	40.80
Gutter – 4.0m				
▽	112	OT074B	5	81.14
▽	112	OT074G	5	81.14
▽	112	OT074W	5	81.14
▽	112	OT074N	5	81.14
Gutter Union and Brackets				
 Gutter Jointing Bracket				
▽	112	OT005B	10	13.18
▽	112	OT005G	5	13.18
▽	112	OT005W	5	13.18
▽	112	OT005N	5	13.18
 Gutter Union				
▽	112	OT009B	10	17.61
▽	112	OT009G	5	17.61
▽	112	OT009W	5	17.61
▽	112	OT009N	5	17.61
 Gutter Support Bracket				
▽	112	OT019B	40	5.81
▽	112	OT019G	20	5.81
▽	112	OT019W	40	5.81
▽	112	OT019N	20	5.81
 Gutter Bracket Spacer – 21mm projection	–	OT044B	20	7.14
 Angled Bracket Spacer	–	OT045B	10	16.49
Outlets and Stopends				
 Running Outlet – straight				
▽	112	OT624B	5	26.64
▽	112	OT624G	5	26.64
▽	112	OT624W	5	26.64
▽	112	OT624N	5	26.64
 Swivelock Running Outlet – with fitted offset bend				
▽	112	OT625B	2	40.61
 Stopend Outlet				
▽	112	OT007B	5	32.78
▽	112	OT007G	5	32.78
▽	112	OT007W	5	32.78
▽	112	OT007N	5	32.78
 Stopend – internal				
▽	112	OT010B	5	8.44
▽	112	OT010G	5	8.44
▽	112	OT010W	5	8.44
▽	112	OT010N	5	8.44











	Description	Nom dia mm	Cat no	Pack qty	Price £ per piece
	Stopend – external	112	OT011B	10	10.87
		112	OT011G	5	10.87
		112	OT011W	5	10.87
		112	OT011N	5	10.87
	Gutter Angles				
	Angle – 90°				
		112	OT003B	5	25.21
		112	OT003G	5	25.21
		112	OT003W	5	25.21
		112	OT003N	5	25.21
	Angle – 60°				
		112	OT016B	5	34.75
	Angle – 45°				
		112	OT004B	5	32.97
		112	OT004G	5	32.97
		112	OT004W	5	32.97
		112	OT004N	5	32.97
	Fabricated angles to order	112	OT999	1	137.51
	Leaf Guard Leaf Guard – 10 no. x 500mm	–	OT017B	1	77.52
	Connectors to Metal and PVC-U Gutters				
	Connector to 4" or 4.5" CI Half-round Gutter				
		112	OT008B	10	29.55
	Connector to 4.5" CI Ogee Gutter – LH				
		112	OT014B	5	50.62
	Connector to 4.5" CI Ogee Gutter – RH				
		112	OT015B	5	50.62
	Rise and Fall Brackets and Spikes				
	Bow and Pin – for Rise and Fall Brackets (for use with Build-in or Drive-in Spikes)				
		112	OT914B	10	24.94
		112	OT914G	10	24.94
		112	OT914W	10	24.94
		112	OT914N	10	24.94
	Build-in Spike – 200mm long	–	OT985B	10	17.74
	– 300mm long	–	OT986B	10	26.65
	Drive-in Spike – 200mm long	–	OT988B	10	14.80
	– 300mm long	–	OT989B	10	19.86
	Rafter Brackets (PVC coated steel)				
	Top Rafter Bracket – 300mm long				
		112	OT745B	20	32.00
	Side Rafter Bracket – 300mm long				
		112	OT746B	20	34.63

Wavin Osma RoundLine

Rainwater half round domestic – PVC-U

Description	Nom dia mm	Cat no	Pack qty	Price £ per piece
 Rafter Bracket (BZP) Adjustable Top Rafter Bracket – 300mm long	–	OT147G	20	38.18
 Adjustable Side Rafter Bracket – 300mm long	–	OT148G	20	35.26
 Rafter Bracket (galvanised) Top Rafter Bracket – 300mm long galvanised	112	OT245B	5	32.54
 Side Rafter Bracket – 300mm long galvanised	112	OT246B	5	32.54
 Pipe P/E Pipe – 2.0m	68	OT082B	5	45.75
♥	68	OT082G	5	45.75
♥	68	OT082N	5	45.75
P/E Pipe – 2.75m	68	OT086B	5	63.99
♥	68	OT086G	5	63.99
♥	68	OT086W	5	63.99
♥	68	OT086N	5	63.99
♥	68	OT086AG	5	63.99
P/E Pipe – 4.0m	68	OT084B	5	91.45
♥	68	OT084G	5	91.45
♥	68	OT084W	5	91.45
♥	68	OT084N	5	91.45
♥	68	OT084AG	5	91.45
P/E Pipe – 5.5m	68	OT088B	5	119.43
♥	68	OT088G	5	119.43
♥	68	OT088W	5	119.43
♥	68	OT088N	5	119.43
♥	68	OT088AG	5	119.43
 Pipe and Socket Brackets Pipe or Socket Bracket	68	OT033B	10	14.41
♥	68	OT033G	5	14.41
♥	68	OT033W	5	14.41
♥	68	OT033N	5	14.41
♥	68	OT033AG	5	14.41
 Pipe Bracket	68	OT034B	20	10.04
♥	68	OT034G	5	10.04
♥	68	OT034W	5	10.04
♥	68	OT034N	5	10.04
♥	68	OT034AG	5	10.04











Note: Anthracite Grey (AG) gutter available in DeepLine profile only.

Description		Nom dia mm	Cat no	Pack qty	Price £ per piece
	Socket Bracket	68	OT038B	10	11.77
	▽	68	OT038G	10	11.77
	▽	68	OT038W	10	11.77
	▽	68	OT038N	10	11.77
	▽	68	OT038AG	10	11.77
	Drive-in Pipe Bracket	68	OT143B	10	33.45
	Pipe Bracket Spacer – for use with OT033	68	OT031B	10	4.78
	Bracket Extension Piece – for use with OT033	68	OT030B	5	5.61
Connectors and Adaptors					
	Pipe Connector	68	OT024B	5	12.27
	▽	68	OT024G	5	12.27
	▽	68	OT024W	5	12.27
	▽	68	OT024N	5	12.27
	▽	68	OT024AG	5	12.27
	Connector to 2.5" CI RW pipe	68	OT092B	5	30.27
	Rainwater Adaptor – 68mm pipe to 110mm PVC-U drain	–	4S149	10	25.49
	Rainwater Adaptor – 68mm pipe to 110mm PVC-U drain	–	OT149B	5	32.03
	Universal Drain Adaptor	–	4S159	10	27.17
Bends and Shoe					
	Offset Bend – socket	68	OT025B	10	15.38
	▽	68	OT025G	5	15.38
	▽	68	OT025W	5	15.38
	▽	68	OT025N	5	15.38
	▽	68	OT025AG	5	15.38
	Offset Bend – spigot	68	OT026B	10	19.12
	▽	68	OT026G	5	19.12
	▽	68	OT026W	5	19.12
	▽	68	OT026N	5	19.12
	▽	68	OT026AG	5	19.12

Note: Anthracite Grey (AG) gutter available in DeepLine profile only.

Wavin Osma RoundLine









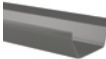

Rainwater half round domestic – PVC-U

	Description	Nom dia mm	Cat no	Pack qty	Price £ per piece
	Long Tail Offset Bend – spigot ▽	68	OT027B	5	23.86
	Pipe Bend – 87.5° ▽	68	OT161B	5	29.66
	▽	68	OT161G	5	29.66
	▽	68	OT161W	5	29.66
	▽	68	OT161N	5	29.66
	▽	68	OT161AG	5	29.66
	Pipe Shoe ▽	68	OT037B	5	16.65
	▽	68	OT037G	5	16.65
	▽	68	OT037W	5	16.65
	▽	68	OT037N	5	16.65
	▽	68	OT037AG	5	16.65
Branch, Access Pipe and Hopper Head					
	Pipe Branch – 67.5° ▽	68	OT035B	5	50.03
	▽	68	OT035G	5	50.03
	▽	68	OT035W	5	50.03
	▽	68	OT035N	5	50.03
	▽	68	OT035AG	5	50.03
	Access Pipe – with screwed door ▽	68	OT274B	5	90.31
	▽	68	OT274G	5	90.31
	▽	68	OT274W	5	90.31
	▽	68	OT274N	5	90.31
	▽	68	OT274AG	5	90.31
	Hopper Head ▽	68	OT332B	5	67.18
	▽	68	OT332G	5	67.18
	▽	68	OT332W	5	67.18
	▽	68	OT332N	5	67.18
	▽	68	OT332AG	5	67.18
Spares					
	Gutter Seal	112	OT064G	5	4.46
	Flexiclip ▽	112	OT116B	1	3.25
	▽	112	OT116G	1	3.25
	▽	112	OT116W	1	3.25
	▽	112	OT116N	1	3.25
	Gutter Pad – narrow	112	OT060B	5	4.46
	Gutter Pad – wide	112	OT061B	5	4.46

Note: Anthracite Grey (AG) gutter available in DeepLine profile only.









Wavin Osma SquareLine









Rainwater square – PVC-U

Description		Nom dia mm	Cat no	Pack qty	Price £ per piece
	Gutter				
	Gutter – 2.0m				
	▽	100	4T872B	5	43.28
	▽	100	4T872W	5	43.28
	▽	100	4T872N	5	43.28
	Gutter – 4.0m				
▽	100	4T874B	5	86.60	
▽	100	4T874W	5	86.60	
▽	100	4T874N	5	86.60	
Gutter Union and Brackets					
	Gutter Jointing Bracket				
	▽	100	4T805B	20	17.09
	▽	100	4T805W	20	17.09
▽	100	4T805N	20	17.09	
	Gutter Union				
	▽	100	4T809B	10	27.27
	▽	100	4T809W	5	27.27
▽	100	4T809N	5	27.27	
	Gutter Support Bracket				
	▽	100	4T819B	20	7.36
	▽	100	4T819W	20	7.36
▽	100	4T819N	20	7.36	
	Gutter Bracket Spacer – 21mm projection	–	OT044B	20	7.14
		–	OT045B	10	16.49
Outlets and Stopends					
	Running Outlet				
	▽	100	4T806B	10	28.40
	▽	100	4T806W	10	28.40
▽	100	4T806N	10	28.40	
	Stopend Outlet				
	▽	100	4T807B	10	30.11
	▽	100	4T807W	10	30.11
▽	100	4T807N	10	30.11	
	Stopend – internal				
	▽	100	4T810B	5	10.90
	▽	100	4T810W	5	10.90
▽	100	4T810N	5	10.90	
	Stopend – external				
	▽	100	4T811B	10	12.58
	▽	100	4T811W	10	12.58
▽	100	4T811N	10	12.58	
Gutter Angles					
	Angle – 90°				
	▽	100	4T803B	10	27.54
	▽	100	4T803W	10	27.54
▽	100	4T803N	10	27.54	

Wavin Osma SquareLine











Rainwater square – PVC-U



Description	Nom dia mm	Cat no	Pack qty	Price £ per piece			
 Angle – 45° ♡ ♡ ♡	100	4T804B	5	38.24			
	100	4T804W	5	38.24			
	100	4T804N	5	38.24			
Fabricated angles to order	100	4T999	1	143.47			
Connectors to Metal and PVC-U Gutter							
 Connector to 4.5" RoundLine Gutter ♡ ♡	100	4T818B	5	46.21			
	100	4T818W	5	46.21			
Rise and Fall Brackets and Spikes							
    	Bow and Pin – for Rise and Fall Brackets (for use with Build-in or in Spikes)						
	100	4T894B	10	30.67			
	–	0T985B	10	17.74			
	–	0T986B	10	26.65			
	–	0T988B	10	14.80			
–	0T989B	10	19.86				
Rafter Brackets (BZP)							
 	Adjustable Top Rafter Bracket – 300mm long						
	–	0T147G	20	38.18			
Adjustable Side Rafter Bracket – 300mm long				–	0T148G	20	35.26

Description		Nom dia mm	Cat no	Pack qty	Price £ per piece
	Pipe				
	P/E Pipe – 2.0m				
	♥	61	4T882B	5	46.14
	♥	61	4T882W	5	46.14
	♥	61	4T882N	5	46.14
	P/E Pipe – 2.75m				
	♥	61	4T886B	5	65.20
	♥	61	4T886W	5	65.20
	♥	61	4T886N	5	65.20
	P/E Pipe – 4.0m				
	♥	61	4T884B	5	94.51
	♥	61	4T884W	5	94.51
	♥	61	4T884N	5	94.51
	P/E Pipe – 5.5m				
	♥	61	4T888B	5	130.02
♥	61	4T888W	5	130.02	
♥	61	4T888N	5	130.02	
Pipe Brackets and Spacer					
	Pipe Bracket – Stand Off				
	♥	61	4T833B	5	9.74
	♥	61	4T833W	5	9.74
	♥	61	4T833N	5	9.74
	Pipe Bracket				
	♥	61	4T834B	5	8.29
	♥	61	4T834W	5	8.29
	♥	61	4T834N	5	8.29
	Pipe Bracket Spacer				
	– for use with 4T834, 4T823, 4T832, 4T858, 4T855	–	4T731B	10	13.78
–	–	4T731W	10	13.78	
Connectors and Adaptors					
	Pipe Connector and Bracket – Stand Off				
	♥	61	4T824B	5	28.62
	♥	61	4T824W	5	28.62
♥	61	4T824N	5	28.62	
	Pipe Connector and Bracket				
	♥	61	4T823B	5	25.91
	♥	61	4T823W	5	25.91
♥	61	4T823N	5	25.91	
	Drain Adaptor – Square to Round				
	♥	61	4T836B	10	23.48
♥	61	4T836W	5	23.48	
	Outlet Adaptor – Square to Round				
	♥	61	4T837B	5	29.29
♥	61	4T837W	5	29.29	
	Rainwater Adaptor 68mm pipe to 110mm PVC–U drain	–	4S149	10	25.49
	Rainwater Adaptor 68mm pipe to 110mm PVC–U drain	–	0T149B	5	32.03
	♥				

Wavin Osma SquareLine















Rainwater square – PVC-U









	Description	Nom dia mm	Cat no	Pack qty	Price £ per piece
	Universal Drain Adaptor	–	4S159	10	27.17
Bends, Shoe and Wall Offsets					
	Offset Bend – socket				
	▽	61	4T825B	20	16.41
	▽	61	4T825W	20	16.41
	▽	61	4T825N	20	16.41
	Offset Bend – spigot				
	▽	61	4T826B	10	20.36
	▽	61	4T826W	10	20.36
	▽	61	4T826N	10	20.36
	Pipe Bend – 87.5°				
	▽	61	4T862B	5	35.02
	▽	61	4T862W	5	35.02
	▽	61	4T862N	5	35.02
	Pipe Shoe and Bracket				
	▽	61	4T832B	5	24.31
	▽	61	4T832W	5	24.31
	▽	61	4T832N	5	24.31
	Pipe Wall Offset				
	▽	61	4T838B	10	32.93
	▽	61	4T838W	10	32.93
	▽	61	4T838N	10	32.93
	Pipe Wall Offset – with access	61	4T858B	5	92.35
Branch, Access Pipe and Hopper Head					
	Pipe Branch – 67.5°				
	▽	61	4T835B	5	67.27
	▽	61	4T835W	5	67.27
	▽	61	4T835N	5	67.27
	Access Pipe	61	4T855B	5	92.35
	Hopper Head				
		61	4T830B	5	84.86
		61	4T830W	5	84.86
		61	4T830N	5	84.86
Spares					
	Gutter Seal	100	4T864B	5	4.29

Description		Nom dia mm	Cat no	Pack qty	Price £ per piece
	Flexiclip	100	4T816B	1	4.00
	♥	100	4T816W	1	4.00
	♥	100	4T816N	1	4.00
	Gutter Pad – narrow	100	4T860G	10	4.48
	Gutter Pad – wide	100	4T861G	10	4.38

Wavin Osma StormLine

Rainwater ogee – PVC-U









	Description	Nom dia mm	Cat no	Pack qty	Price £ per piece
	Gutter				
	Gutter – 4.0m	111	8T874B	4	117.50
		111	8T874W	4	117.50
Gutter Unions and Brackets					
	Gutter Jointing Bracket	111	8T809B	10	25.14
	▽	111	8T809W	10	25.14
	Gutter Support Bracket	111	8T819B	10	9.33
	▽	111	8T819W	10	9.33
	Gutter Hanging Bracket	111	8T849B	20	12.41
	▽	111	8T849W	20	12.41
	Gutter Bracket Spacer – 21mm projection	–	0T044B	20	7.14
Outlets and Stopends					
	Running Outlet	111	8T806B	5	33.55
	▽	111	8T806W	5	33.55
	Stopend Outlet (left hand)	111	8T807B	5	31.09
	▽	111	8T807W	5	31.09
	Stopend Outlet (right hand)	111	8T808B	5	31.09
	▽	111	8T808W	5	31.09
	Stopend – internal (left hand)	111	8T840B	5	14.13
	▽	111	8T840W	5	14.13
	Stopend – internal (right hand)	111	8T850B	5	14.13
	▽	111	8T850W	5	14.13
	Stopend – external (left hand)	111	8T841B	10	19.77
	▽	111	8T841W	10	19.77
	Stopend – external (right hand)	111	8T851B	10	19.77
	▽	111	8T851W	10	19.77
Gutter Angles					
	Angle – 90° (internal)	111	8T843B	5	36.99
	▽	111	8T843W	5	36.99
	Angle – 90° (external)	111	8T853B	5	32.92
	▽	111	8T853W	5	32.92

	Description	Nom dia mm	Cat no	Pack qty	Price £ per piece
	Angle – 45° (internal)	111	8T844B	5	38.91
	▽	111	8T844W	5	38.91
	Angle – 45° (external)	111	8T854B	5	38.91
	▽	111	8T854W	5	38.91
	Fabricated angles to order	–	8T999	1	159.21
Rise and Fall Brackets and Spikes					
	Bow and Pin – For Rise and Fall Brackets (for use with Build-in or Drive-in Spikes)	111	8T894B	10	36.87
	Build-in Spike – 200mm long	–	0T985B	10	17.74
	– 300mm long	–	0T986B	10	26.65
	Drive-in Spike – 200mm long	–	0T988B	10	14.80
	– 300mm long	–	0T989B	10	19.86
Rafter Brackets (BZP)					
	Adjustable Top Rafter Bracket – 300mm long	–	0T147G	20	38.18
	Adjustable Side Rafter Bracket – 300mm long	–	0T148G	20	35.26
Spares					
	Gutter Seal	111	8T864B	1	3.58
	Flexiclip	111	8T816B	1	3.77
	▽	111	8T816W	1	3.77

Note: For details of 61mm (2¼") and 68mm (2½") pipe and fittings for use with the StormLine Rainwater System refer to pages 11-13 and 6-8.









Wavin Osma DeepLine

Rainwater high capacity – PVC-U

Description		Nom dia mm	Cat no	Pack qty	Price £ per piece
	Gutter				
	Gutter – 4.0m				
	▽	113	9T974B	5	94.91
	▽	113	9T974G	5	94.91
	▽	113	9T974W	5	94.91
	▽	113	9T974N	5	94.91
	▽	113	9T974AG	5	94.91
Gutter Union and Brackets					
	Gutter Union				
	▽	113	9T909B	5	20.74
	▽	113	9T909G	5	20.74
	▽	113	9T909W	5	20.74
	▽	113	9T909N	5	20.74
	▽	113	9T909AG	5	20.74
	Gutter Support Bracket				
	▽	113	9T919B	40	7.23
	▽	113	9T919G	20	7.23
	▽	113	9T919W	20	7.23
	▽	113	9T919N	20	7.23
	▽	113	9T919AG	20	7.23
	Gutter Bracket Spacer				
	– 21mm projection	–	OT044B	20	7.14
	Angled Bracket Spacer				
		–	OT045B	10	16.49
Outlet and Stopends					
	Running Outlet				
	▽	113	9T906B	5	25.48
	▽	113	9T906G	5	25.48
	▽	113	9T906W	5	25.48
	▽	113	9T906N	5	25.48
	▽	113	9T906AG	5	25.48
	Stopend – internal				
	▽	113	9T910B	5	9.05
	▽	113	9T910G	5	9.05
	▽	113	9T910W	5	9.05
	▽	113	9T910N	5	9.05
	▽	113	9T910AG	5	9.05
	Stopend – external				
	▽	113	9T911B	5	12.75
	▽	113	9T911G	5	12.75
	▽	113	9T911W	5	12.75
	▽	113	9T911N	5	12.75
	▽	113	9T911AG	5	12.75

Note:







For details of 68mm (2½") pipe and fittings for use with DeepLine profile refer to pages 6-8.

Description		Nom dia mm	Cat no	Pack qty	Price £ per piece
Gutter Angles					
	Angle – 90°	113	9T903B	5	32.97
	▽	113	9T903G	5	32.97
	▽	113	9T903W	5	32.97
	▽	113	9T903N	5	32.97
	▽	113	9T903AG	5	32.97
	Angle – 45°	113	9T904B	5	37.78
	▽	113	9T904G	5	37.78
	▽	113	9T904W	5	37.78
	▽	113	9T904N	5	37.78
	▽	113	9T904AG	5	37.78
Fabricated angles to order		113	9T999	1	145.26
Rise and Fall Brackets and Spikes					
	Bow and Pin – for Rise and Fall Brackets (for use with Build-in or Drive-in Spikes)	113	9T994B	10	33.58
		113	9T994G	10	33.58
		113	9T994AG	10	33.58
	Build-in Spike – 200mm long	–	0T985B	10	17.74
	– 300mm long	–	0T986B	10	26.65
	Drive-in Spike – 200mm long	–	0T988B	10	14.80
	– 300mm long	–	0T989B	10	19.86
Rafter Brackets (BZP)					
	Adjustable Top Rafter Bracket – 300mm long	–	0T147G	20	38.18
	Adjustable Side Rafter Bracket – 300mm long	–	0T148G	20	35.26
Spares					
	Gutter Seal	113	9T964B	10	3.42
	Flexiclip	113	9T916B	1	3.49
	▽	113	9T916G	1	3.49
	▽	113	9T916W	1	3.49
	▽	113	9T916N	1	3.49
	▽	113	9T916AG	1	3.49

Wavin Osma SuperLine

Rainwater half round commercial – PVC-U













	Description	Nom dia mm	Cat no	Pack qty	Price £ per piece
	Gutter Gutter – 4.0m ▽	125	5T574B	5	125.11
	Gutter Union and Brackets Gutter Union ▽	125	5T509B	5	24.95
	Gutter Support Bracket ▽	125	5T519B	5	9.11
	Gutter Bracket Spacer – 21mm projection	–	0T044B	20	7.14
	Angled Bracket Spacer	–	0T045B	10	16.49
	Outlet and Stopends Running Outlet ▽	125	5T508B	5	37.26
	Stopend – internal ▽	125	5T510B	5	12.12
	Stopend – external ▽	125	5T511B	5	18.27
	Gutter Angles Angle – 90° ▽	125	5T503B	5	41.70
	Angle – 45° ▽	125	5T504B	5	47.52
	Rise and Fall Brackets and Spikes Bow and Pin – for Rise and Fall Brackets (for use with Build-in or Drive-in-Spikes)	125	5T594B	5	40.12
	Build-in Spike – 200mm long – 300mm long	– –	0T985B 0T986B	10 10	17.74 26.65
	Drive-in Spike – 200mm long – 300mm long	– –	0T988B 0T989B	10 10	14.80 19.86





Description	Nom dia mm	Cat no	Pack qty	Price £ per piece
 Rafter Brackets (PVC Coated Steel) Top Rafter Bracket – 300mm long	125	5T595B	10	43.28
 Side Rafter Bracket – 300mm long	125	5T596B	10	45.79
 Rafter Bracket (BZP) Adjustable Top Rafter Bracket – 300mm long	–	0T147G	20	38.18
 Adjustable Side Rafter Bracket – 300mm long	–	0T148G	20	35.26
 Rainwater Hopper Hopper Head	110	4S326B	5	148.64
 Spares Gutter Seal	125	5T564B	10	4.85
 Flexiclip ♡	125	5T516B	1	4.28

Note: For details of 68mm (2½") pipe and fittings for use with the SuperLine Rainwater System refer to pages 6-8.

Wavin Osma RoofLine

Rainwater half round commercial – PVC-U









Description		Nom dia mm	Cat no	Pack qty	Price £ per piece
	Gutter Gutter – 4.0m	150	6T674B	5	252.29
	▽ ▽	150	6T674G	5	252.29
Gutter Union and Bracket					
	Gutter Union	150	6T609B	5	67.06
	▽ ▽	150	6T609G	5	67.06
	Gutter Support Bracket	150	6T619B	10	23.48
	▽ ▽	150	6T619G	10	23.48
	Gutter Bracket Spacer – 21mm projection	–	0T044B	20	7.14
Outlet and Stopends					
	Running Outlet	150	6T606B	5	92.09
	▽ ▽	150	6T606G	5	92.09
	Stopend – internal	150	6T610B	5	15.78
	▽ ▽	150	6T610G	5	15.78
	Stopend – external	150	6T611B	5	45.69
	▽ ▽	150	6T611G	5	45.69
Gutter Angles					
	Angle – 90°	150	6T603B	5	129.34
	▽ ▽	150	6T603G	5	129.34
	Fabricated angles to order	150	6T999	1	231.81
Rise and Fall Brackets and Spikes					
	Bow and Pin – for Rise and Fall Brackets (for use with Build-in or Drive-in Spikes)	150	6T694B	20	50.86
		150	6T694G	20	50.86
	Build-in Spike – 200mm long – 300mm long	– –	0T985B 0T986B	10 10	17.74 26.65
	Drive-in Spike – 200mm long – 300mm long	– –	0T988B 0T989B	10 10	14.80 19.86
Rafter Brackets (PVC coated steel)					
	Top Rafter Bracket – 300mm long	150	6T695B	10	47.48
	Side Rafter Bracket – 300mm long	150	6T696B	10	50.23

Description	Nom dia mm	Cat no	Pack qty	Price £ per piece
Rafter Brackets (BZP)				
 Adjustable Top Rafter Bracket – 300mm long	–	0T147G	20	38.18
 Adjustable Side Rafter Bracket – 300mm long	–	0T148G	20	35.26
Rainwater Hopper				
 Hopper Head	110	4S326B	5	148.64
	110	4S326G	5	148.64
Spares				
 Gutter Seal	150	6T664B	4	5.22
 Flexiclip	150	6T616B	1	4.79
	150	6T616G	1	4.79









Note: For details of 110mm (4") pipe and fittings for use with the RoofLine Rainwater System refer to pages 22-35.

Wavin OsmaSoil

Soil and Vent PVC-U Ring-seal system

Description		Nom dia mm	Cat no	Pack qty	Price £ per piece
	Pipe S/S Pipe – 2.0m ♻️△	110	4S042B	2	106.45
	♻️△	110	4S042G	2	106.45
	S/S Pipe – 2.5m ♻️△	110	4S050G	50	126.21
	Recycore Technology™ S/S Pipe – 3.0m ♻️	82	3S043B	2	161.22
	♻️	82	3S043G	2	161.22
	♻️△	110	4S043B	2	139.94
	♻️△	110	4S043G	2	139.94
	♻️△	110	4S043W	2	139.94
	♻️△	160	6S043G	2	521.22
	S/S Pipe – 4.0m ♻️△	110	4S044B	2	188.80
	♻️△	110	4S044G	2	188.80
♻️△	110	4S044W	2	188.80	
	♻️△	160	6S044G	2	678.20
	P/E Pipe – 3.0m ♻️△	110	4S073B	2	134.63
	♻️△	110	4S073G	2	134.63
	♻️△	110	4S073W	2	134.63
	P/E Pipe – 4.0m ♻️	82	3S074G	2	210.28
	♻️△	110	4S074B	2	179.48
	♻️△	110	4S074G	2	179.48
	♻️△	110	4S074W	2	179.48
	♻️△	160	6S074B	2	627.91
	♻️△	160	6S074G	2	627.91
	♻️△	160	6S074G	2	627.91
Brackets					
	Pipe Bracket ♻️	82	3S082B	5	14.49
	♻️	82	3S082G	5	14.49
	♻️	110	4S082B	10	12.39
	♻️	110	4S082G	10	12.39
	♻️	110	4S082W	10	12.39
	♻️	160	6S082B	1	45.43
	♻️	160	6S082G	1	45.43
	♻️	160	6S082G	1	45.43
	Socket Bracket ♻️	82	3S083B	5	19.27
	♻️	82	3S083G	5	19.27
	♻️	110	4S083B	5	16.51
	♻️	110	4S083G	5	16.51
	♻️	110	4S083W	5	16.51
	Pipe or Socket Bracket – BZP coated steel ♻️	110	4S084	10	35.78
	♻️	160	6S084	1	75.47











Note: △ Recycore Technology applies to 110mm and 160mm sizes only.

Description		Nom dia mm	Cat no	Pack qty	Price £ per piece
Suspended Bracketing System					
	(Not suitable for damp inaccessible voids) Adjustable Pipe Bracket Assembly (pack containing threaded rod, threaded bracket, bracket plate and pipe/socket bracket) – BZP coated steel	110	4S086	1	116.24
	Adjustable Socket Bracket and Brace Assembly (pack containing threaded rod, threaded bracket, bracket plate, two adjustable braces and pipe/socket bracket) – BZP coated steel	110	4S085	1	239.24
Sockets					
	D/SW Double Socket	110	4S104B	5	27.23
	♥	110	4S104G	5	27.23
	♥	110	4S104W	5	27.23
	♥	160	6S104B	1	65.99
	♥	160	6S104G	1	65.99
	D/S Double Socket – for repairs	82	3S105B	5	54.47
	♥	82	3S105G	5	54.47
	♥	110	4S105B	5	58.81
	♥	110	4S105G	5	58.81
	♥	110	4S105W	5	58.81
	♥	160	6S105G	1	165.69
	S/SW Single Socket	82	3S124B	5	31.76
	♥	82	3S124G	5	31.76
	♥	110	4S124B	5	28.36
	♥	110	4S124G	5	28.36
	♥	110	4S124W	5	28.36
	♥	160	6S124B	1	97.06
	♥	160	6S124G	1	97.06
	D/S Acoustic Socket	110	4S125B	5	43.08
	♥	110	4S125G	5	43.08
	D/S Double Socket	110	4S205B	10	50.68
		110	4S205G	10	50.68
		110	4S205W	10	50.68
Connectors					
	S/S Connector to CI soil socket	110	4S106G	5	80.15

Wavin OsmaSoil











Soil and Vent PVC-U Ring-seal system











Description		Nom dia mm	Cat no	Pack qty	Price £ per piece
	Connector to CI soil socket – synthetic rubber	110	4S206B	5	87.10
	Internal Drain Connector for 32mm/40mm waste pipe	110	4S298	5	28.79
	Internal Drain Connector – for 50mm waste pipe	110	4S299	5	33.14
Reducers					
	S/S Reducer – 82mm x 50mm	82	3S094B	5	66.55
	▽	82	3S094G	5	66.55
	Reducer – 110mm x 32mm waste	110	4S098G	5	65.96
	– 110mm x 40mm waste	110	4S097G	5	65.96
	S/S Reducer – 110mm x 50mm	110	4S096B	5	62.61
	▽	110	4S096G	5	62.61
	S/S Reducer – 110mm x 82mm	110	4S095B	5	57.43
	▽	110	4S095G	5	57.43
	S/S Reducer – 160mm x 110mm	160	6S099G	1	147.02
Bends					
	S/S Bend – 87.5°	82	3S161B	5	64.48
	▽	82	3S161G	5	64.48
	▽	110	4S161B	5	75.09
	▽	110	4S161G	5	75.09
	▽	110	4S161W	5	75.09
	▽	160	6S161G	1	254.28
	S/SW Bend – 87.5°	110	4S361G	5	73.92
	S/S Tight Radius Bend – 87.5°	110	4S160B	10	83.41
	▽	110	4S160G	10	83.41
	▽	110	4S160W	10	83.41

Description		Nom dia mm	Cat no	Pack qty	Price £ per piece
	D/S Bend – 87.5°	110	4S561B	5	93.66
		110	4S561G	5	93.66
		110	4S561W	5	93.66
	S/S Bend – 76°	110	4S164B	5	106.94
	▽	110	4S164G	5	106.94
	S/S Bend – 67.5°	110	4S162G	5	107.78
	▽				
	S/S Bend – 45°	82	3S163B	5	64.48
	▽	82	3S163G	5	64.48
	▽	110	4S163B	5	75.09
	▽	110	4S163G	5	75.09
	▽	110	4S163W	5	75.09
	▽	160	6S163G	1	254.28
	S/SW Bend – 45°	110	4S363B	5	73.92
	▽	110	4S363G	5	73.92
	▽	110	4S363W	5	73.92
	S/S Bend – 30°	110	4S166G	5	83.15
	▽				
	S/S Bend – 15°	110	4S167G	5	95.69
	▽				
Adjustable Bends					
	S/S Adjustable Bend – 30°	110	4S173G	1	94.34
	▲				
	S/S Adjustable Bend – 90°	110	4S179G	1	106.67
	▲				
Offset Bends					
	SW/S Offset Bend (bottom)	82	3S435G	5	67.19
	▽	110	4S435B	5	70.08
	▽	110	4S435G	5	70.08
	▽	110	4S435W	5	70.08

Wavin OsmaSoil











Soil and Vent PVC-U Ring-seal system









	Description	Nom dia mm	Cat no	Pack qty	Price £ per piece
	S/SW Offset Bend (top)				
	♥	82	3S440B	5	79.28
	♥	82	3S440G	5	79.28
	♥	110	4S440B	5	96.13
	♥	110	4S440G	5	96.13
	♥	110	4S440W	5	96.13
	S/S Offset Bend				
	♥	110	4S444B	5	96.13
	♥	110	4S444G	5	96.13
	♥	110	4S444W	5	96.13
	D/S Offset Bend				
	♥	110	4S445B	5	106.94
	♥	110	4S445G	5	106.94
	♥	110	4S445W	5	106.94
Manifolds					
	6 Boss Manifold	110	4S597G	1	118.08
	OsmaLink Soil Manifold				
♥		110	4S595G	1	129.83
	All-Fit Reducer – 1½" / 40 x 1¼" / 32	40	4Z124W	10	11.77
	All-Fit Reduction Bend – 2" / 50 x 1½" / 40	50	2S355W	10	17.25
	All-Fit 90° Spigot Bend – 2" / 50	50	2S356W	5	28.39
Branches					
	S/S Single Branch – 87.5°				
	♥	82	3S190B	5	114.78
	♥	82	3S190G	5	114.78
	♥	110	4S190B	5	105.99
	♥	110	4S190G	5	105.99
	♥	110	4S190W	5	105.99
	S/S Single 5 Boss Branch – 87.5°				
	♥	110	4S195B	5	137.39
	♥	110	4S195G	5	137.39
	♥	110	4S195W	5	137.39

Description		Nom dia mm	Cat no	Pack qty	Price £ per piece
	S/SW Single 5 Boss Branch – 87.5° ♥	110	4S395G	5	119.15
	S/S Unequal Single Branch – 87.5° ♥	160	6S198G	1	353.94
	S/S Single Branch – 76° ♥	110	4S220B	1	153.74
	♥	110	4S220G	1	153.74
	S/S Single Branch – 67.5° ♥	110	4S200B	1	153.74
	♥	110	4S200G	1	153.74
	S/S Single Branch – 45° ♥	82	3S210G	5	114.78
	♥	110	4S210B	5	157.56
	♥	110	4S210G	5	157.56
160x110mm ♥	160	6S218G	1	353.94	
160x160mm ♥	160	6S210G	1	459.25	
	S/S Double Branch – 87.5° ♥	110	4S230B	1	265.05
	♥	110	4S230G	1	265.05
	♥	110	4S230W	1	265.05
	S/S Unequal Double Branch – 87.5° ♥	160	6S238G	1	625.48
	S/S Double Branch – 45° ♥	110	4S250G	1	330.42
	S/S Corner Branch – 87.5° ♥	110	4S291G	1	417.24
Boss Socket Adaptors					
	S/S Boss Adaptor (Ring-Seal) – for 1¼" / 32 plastic or copper pipe ♥	32	2S398B	10	14.83
	♥	32	2S398G	10	14.83
	♥	32	2S398W	5	14.83

Wavin OsmaSoil







Soil and Vent PVC-U Ring-seal system

	Description	Nom dia mm	Cat no	Pack qty	Price £ per piece
	S/S Boss Adaptor (Ring-Seal) – for 1½" / 40 plastic or copper pipe				
	▽	40	2S399B	5	14.83
	▽	40	2S399G	10	14.83
	▽	40	2S399W	10	14.83
	S/S Boss Adaptor (Ring-Seal) – 2" / 50 plastic or copper pipe				
	▽	50	2S402B	5	19.12
	▽	50	2S402G	5	19.12
	▽	50	2S402W	5	19.12
	S/S Boss Adaptor 90° (Ring-Seal) – for 2" / 50 BS EN 1329, 1455 and 1566 pipe				
	▽	50	2S360G	10	21.04
Bossed Pipes					
	S/S Bossed Pipe – plain with one boss socket				
	▽	82	3S649B	10	61.55
	▽	82	3S649G	10	61.55
	S/S Bossed Pipe – for 1¼" / 32 plastic or copper pipe				
	▽ – NEW	110	4S581B	5	80.55
	▽	110	4S581G	5	80.55
	S/S Bossed Pipe – for 1½" / 40 plastic or copper pipe				
	▽ – NEW	110	4S582B	5	64.52
	▽	110	4S582G	5	64.52
	D/SW Bossed Pipe (Ring Seal) – for 1¼" / 32 plastic or copper pipe				
	▽	110	4S583B	5	31.30
	▽	110	4S583G	5	31.30
	▽	110	4S583W	5	31.30
	D/SW Bossed Pipe (Ring Seal) – for 1½" / 40 plastic or copper pipe				
	▽	110	4S584B	5	27.20
	▽	110	4S584G	5	27.20
	▽	110	4S584W	5	27.20
	D/SW Short Bossed Pipe				
		110	4S588B	5	26.99
		110	4S588G	5	26.99
	– NEW	110	4S588W	5	26.99
	S/S Bossed Pipe – plain with four boss sockets				
	▽	110	4S589B	5	43.89
	▽	110	4S589G	5	43.89
	▽	110	4S589W	5	43.89

Description		Nom dia mm	Cat no	Pack qty	Price £ per piece
	S/SW Bossed Pipe – plain with four boss sockets	110	4S590B	5	52.30
	♥	110	4S590G	5	52.30
Strap Bosses					
	Strap Boss	82	3S319B	5	30.02
	♥	82	3S319G	5	30.02
	♥	110	4S319B	5	25.18
	♥	110	4S319G	5	25.18
	♥	110	4S319W	5	25.18
	Clip Boss For Push-fit or Solvent Waste – 32mm	110	4S322B	10	30.98
		110	4S322G	10	30.98
		110	4S322W	10	30.98
	For Push-fit or Solvent Waste – 40mm	110	4S321B	5	30.98
		110	4S321G	5	30.98
		110	4S321W	5	30.98
	Patch Boss For Push-fit or Solvent Waste – 50mm	160	6S323G	1	61.01
Access Fittings					
	S/S Access Bend – 87.5°	110	4S169B	5	176.66
	♥	110	4S169G	5	176.66
	♥	110	4S169W	5	176.66
	S/SW Access Bend – 87.5°	110	4S369G	5	202.99
	♥				
	S/S Access Branch – 87.5°	110	4S502B	1	239.24
	♥	110	4S502G	1	239.24
	S/S Access Pipe – with bolted door	82	3S274B	5	126.72
	♥	82	3S274G	5	126.72

Wavin OsmaSoil









Soil and Vent PVC-U Ring-seal system

Description		Nom dia mm	Cat no	Pack qty	Price £ per piece
	S/S Bossed Access Pipe – with screwed access and three boss sockets				
	▽	110	4S274B	1	127.14
	▽	110	4S274G	5	127.14
	▽	110	4S274W	1	127.14
	S/SW Bossed Access Pipe – with screwed access and three boss sockets				
	▽	110	4S374G	10	129.08
	Access Saddle				
	▽	110	4S275B	1	69.17
	▽	110	4S275G	1	69.17
Plugs					
	P/E Access Plug				
	▽	82	3S292B	5	62.73
	▽	82	3S292G	5	62.73
	▽	110	4S292B	1	58.71
	▽	110	4S292G	1	58.71
	▽	110	4S292W	1	58.71
	P/E Socket Plug – with one boss socket				
	▽	110	4S296B	5	41.38
	▽	110	4S296G	5	41.38
	▽	110	4S296W	5	41.38
Spares					
	Snap Cap				
		82	3S116B	1	3.77
		82	3S116G	1	3.77
		110	4S116B	1	12.17
		110	4S116G	1	12.17
	T Ring Seal				
		110	4S130G	5	8.77
		160	6S130G	5	15.56

Note: For OsmaSoil WC Connectors, Terminal Fittings and Ancillary Items see pages 36-39.

Wavin OsmaSoil











Soil and Vent PVC-U Solvent Weld system











Description		Nom dia mm	Cat no	Pack qty	Price £ per piece	
 <p>Pipe P/E Pipe – 3.0m</p> <p>▽△ ▽△ ▽△</p> <p>P/E Pipe – 4.0m</p> <p>▽△ ▽△ ▽△ ▽△ ▽△</p> <p>Made with Wavin Recycore Technology™</p> <p>50% RECYCLED RAW MATERIAL</p>	P/E Pipe – 3.0m	110	4S073B	2	134.63	
		110	4S073G	2	134.63	
		110	4S073W	2	134.63	
	P/E Pipe – 4.0m	110	4S074B	2	179.48	
		110	4S074G	2	179.48	
		110	4S074W	2	179.48	
		160	6S074B	2	627.91	
		160	6S074G	2	627.91	
	Brackets					
	 <p>Pipe Bracket</p> <p>▽ ▽ ▽ ▽ ▽</p>	Pipe Bracket	110	4S082B	10	12.39
		110	4S082G	10	12.39	
		110	4S082W	10	12.39	
		160	6S082B	1	45.43	
		160	6S082G	1	45.43	
 <p>Socket Bracket</p> <p>▽ ▽ ▽</p>		Socket Bracket	110	4S083B	5	16.51
		110	4S083G	5	16.51	
		110	4S083W	5	16.51	
	 <p>Pipe or Socket Bracket – BZP coated steel</p> <p>110 160</p>		110	4S084	10	35.78
		160	6S084	1	75.47	
Suspended Bracketing System						
 <p>(Not suitable for damp inaccessible voids)</p> <p>Adjustable Pipe Bracket Assembly (pack containing threaded rod, threaded bracket, bracket plate and pipe/socket bracket) – BZP coated steel</p>	Adjustable Pipe Bracket Assembly (pack containing threaded rod, threaded bracket, bracket plate and pipe/socket bracket) – BZP coated steel	110	4S086	1	116.24	
	 <p>Adjustable Socket Bracket and Brace Assembly (pack containing threaded rod, threaded bracket, bracket plate, two adjustable braces and pipe/socket bracket) – BZP coated steel</p>	Adjustable Socket Bracket and Brace Assembly (pack containing threaded rod, threaded bracket, bracket plate, two adjustable braces and pipe/socket bracket) – BZP coated steel	110	4S085	1	239.24
Sockets						
 <p>D/SW Double Socket</p> <p>▽ ▽ ▽ ▽ ▽</p>	D/SW Double Socket	110	4S104B	5	27.23	
		110	4S104G	5	27.23	
		110	4S104W	5	27.23	
		160	6S104B	1	65.99	
		160	6S104G	1	65.99	
	 <p>D/S Double Socket – for repairs</p> <p>▽ ▽ ▽ ▽</p>	D/S Double Socket – for repairs	110	4S105B	5	58.81
		110	4S105G	5	58.81	
		110	4S105W	5	58.81	
		160	6S105G	1	165.69	

Note: △ Recycore Technology applies to 110mm and 160mm sizes only.

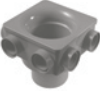
Wavin OsmaSoil









Soil and Vent PVC-U Solvent Weld system











	Description	Nom dia mm	Cat no	Pack qty	Price £ per piece
	S/SW Single Socket				
	▽	110	4S124B	5	28.36
	▽	110	4S124G	5	28.36
	▽	110	4S124W	5	28.36
	▽	160	6S124B	1	97.06
	▽	160	6S124G	1	97.06
	D/S Acoustic Socket				
	▽	110	4S125B	5	43.08
	▽	110	4S125G	5	43.08
Connectors					
	Connector to CI soil socket – synthetic rubber	110	4S206B	5	87.10
Reducers					
	SW/S Reducer – 110mm x 50mm				
	▽	110	4S496B	5	56.49
	▽	110	4S496G	5	56.49
	S/S Reducer – 110mm x 82mm				
	▽	110	4S095B	5	57.43
	▽	110	4S095G	5	57.43
	SW/S Reducer – 160mm x 110mm				
	▽	160	6S499B	1	106.50
	▽	160	6S499G	1	106.50
Expansion Cap					
	– with integral ring-seal				
	▽	110	4S416B	5	13.49
	▽	110	4S416G	5	13.49
Bends					
	D/SW Bend – 87.5°				
	▽	110	4S461B	5	73.83
	▽	110	4S461G	5	73.83
	▽	110	4S461W	5	73.83
	▽	160	6S461B	1	194.51
	▽	160	6S461G	5	194.51
	D/SW Bend – 67.5°				
	▽	110	4S462B	5	79.88
	▽	110	4S462G	5	79.88
	D/SW Bend – 45°				
	▽	110	4S463B	5	73.75
	▽	110	4S463G	5	73.75
	▽	160	6S463B	1	199.22
	▽	160	6S463G	5	199.22
	SW/S Bend – 45°				
	▽	110	4S263B	5	79.88
	▽	110	4S263G	5	79.88

Description		Nom dia mm	Cat no	Pack qty	Price £ per piece
	SW/S Bend – 11.25° ▽	110	4S268B	5	77.07
	▽	110	4S268G	5	77.07
	SW/S Long Tail Bend – 87.5° ▽	110	4S260B	5	84.84
	▽	110	4S260G	5	84.84
Offset Bends					
	SW/S Offset Bend (bottom) ▽	110	4S435B	5	70.08
	▽	110	4S435G	5	70.08
	▽	110	4S435W	5	70.08
	D/SW Offset Bend (top) ▽	110	4S450B	5	78.20
	▽	110	4S450G	1	78.20
Manifold					
	6 Boss Manifold	110	4S597G	1	118.08
Branches					
	D/SW Single Branch – 87.5° ▽	110	4S490B	5	104.38
	▽	110	4S490G	5	104.38
	▽	160	6S490B	1	332.11
	▽	160	6S490G	5	332.11
	SW/S Single Branch – 87.5° ▽	110	4S290B	5	104.44
	▽	110	4S290G	5	104.44
	D/SW Single 5 Boss Branch – 87.5° ▽	110	4S495B	5	108.64
	▽	110	4S495G	5	108.64
	D/SW Unequal Single Branch – 87.5° ▽	160	6S498B	1	256.21
	▽	160	6S498G	5	256.21
	D/SW Single Branch – 45° ▽	110	4S410B	5	117.99
	▽	110	4S410G	5	117.99
	D/SW Double Branch – 87.5° ▽	110	4S430B	1	261.28
	▽	110	4S430G	5	261.28

Wavin OsmaSoil



Soil and Vent PVC-U Solvent Weld system



	Description	Nom dia mm	Cat no	Pack qty	Price £ per piece
	SW/S Corner Branch – 87.5°	110	4S491B	1	462.41
	▽	110	4S491G	5	462.41
Boss Socket Adaptors					
	SW/S Boss Adaptor (Solvent Weld)				
	– for 1 1/4" / 32mm BS EN 1329, 1455 and 1566 pipe	32	2S298B	10	13.79
	▽	32	2S298G	10	13.79
	▽	32	2S298W	10	13.79
	SW/S Boss Adaptor (Solvent Weld)				
	– 1 1/2" / 40mm BS EN 1329, 1455 and 1566 pipe	40	2S299B	10	12.73
	▽	40	2S299G	10	12.73
	▽	40	2S299W	10	12.73
	SW/S Boss Adaptor (Solvent Weld)				
	– for 2" / 50mm BS EN 1329, 1455 and 1566 pipe	50	2S403B	5	15.19
	▽	50	2S403G	5	15.19
	▽	50	2S403W	5	15.19
Bossed Pipes					
	D/SW Bossed Pipe (Solvent Weld)				
	– for 1 1/4" / 32mm BS EN 1329, 1455 and 1566 pipe	110	4S483B	5	32.43
	▽	110	4S483G	5	32.43
	D/SW Bossed Pipe (Solvent Weld)				
	– 1 1/2" / 40mm BS EN 1329, 1455 and 1566 pipe	110	4S484B	5	32.43
	▽	110	4S484G	5	32.43
	D/SW Bossed Pipe				
	– plain (four boss sockets)	110	4S586B	5	36.10
	▽	110	4S586G	5	36.10
	SW/S Bossed Pipe				
	– plain (four boss sockets)	110	4S585B	5	36.10
	▽	110	4S585G	5	36.10
	D/SW Short Bossed Pipe	110	4S588B	5	26.99
		110	4S588G	5	26.99
		110	4S588W	5	26.99

Description		Nom dia mm	Cat no	Pack qty	Price £ per piece
	S/SW Bossed Pipe – plain (four boss sockets)				
	▽	110	4S590B	5	52.30
	▽	110	4S590G	5	52.30
Strap Boss					
	▽	110	4S319B	5	25.18
	▽	110	4S319G	5	25.18
	▽	110	4S319W	5	25.18
Access Fittings					
	D/SW Access Bend – 87.5°				
	▽	110	4S469B	5	186.10
	▽	110	4S469G	5	186.10
	D/SW Access Branch – 87.5°				
	▽	110	4S493B	1	198.09
	SW/S Bossed Access Pipe – with screwed access and three boss sockets				
	▽	110	4S574B	5	123.74
	▽	110	4S574G	1	123.74
	▽	160	6S474B	1	280.54
	▽	160	6S474G	1	280.54
	D/SW Bossed Access Pipe – with screwed access and three boss sockets				
	▽	110	4S474B	5	123.74
	▽	110	4S474G	5	123.74
	Access Saddle				
	▽	110	4S275B	1	69.17
	▽	110	4S275G	1	69.17
Plugs					
	P/E Access Plug				
	▽	82	3S292B	5	62.73
	▽	82	3S292G	5	62.73
	▽	110	4S292B	1	58.71
	▽	110	4S292G	1	58.71
	▽	110	4S292W	1	58.71
	▽	160	6S292B	1	128.38
▽	160	6S292G	1	128.38	
	SW/S Access Plug				
	▽	110	4S492B	5	73.95
	▽	110	4S492G	1	73.95
	P/E Socket Plug – with one boss socket				
	▽	110	4S296B	5	41.38
	▽	110	4S296G	5	41.38
	▽	110	4S296W	5	41.38

Wavin OsmaSoil



WC connectors

Description		Nom dia mm	Cat no	Pack qty	Price £ per piece
WC Manifold Branches (for WC to BS 5503)					
	S/SW Manifold Branch – Straight ▽	110	4S601W	1	374.16
	S/SW Manifold Branch – 8° (LH) ▽	110	4S602W	1	374.16
	(RH) ▽	110	4S612W	1	374.16
	S/SW Manifold Branch – 15.5° (LH) ▽	110	4S603W	1	374.16
	(RH) ▽	110	4S613W	1	374.16
	S/SW Manifold Branch – 23° (LH) ▽	110	4S604W	1	374.16
	(RH) ▽	110	4S614W	1	374.16
	S/SW Manifold Branch – 30.5° (LH) ▽	110	4S605W	1	374.16
	(RH) ▽	110	4S615W	1	374.16
	S/SW Manifold Branch – 38° (LH) ▽	110	4S606W	1	374.16
	(RH) ▽	110	4S616W	1	374.16
WC Connectors (for WCs to BS 5503)					
	P/E WC Connector – 2.5° ▽	110	4S791W	10	56.85
	P/E WC Connector – 14° ▽	110	4S711W	5	67.41
	P/E WC Connector – 90° ▽	110	4S771W	10	96.45
	SW/S WC Connector – 90° ▽	110	4S772W	10	83.70
WC Gaskets					
	WC Gasket – for WC spigots from 4" to 4¼"	110	4S121W	10	34.59
	WC Gasket – for WC spigots from 4¼" to 4½"	110	4S120W	10	32.43

Description		Nom dia mm	Cat no	Pack qty	Price £ per piece
	WC Connectors – Ancillary Products S/S Long Tail Bend – 87.5° ♻️	110	4S790W	5	96.13
	P/E Pipe – 600mm length ♻️ ♻️	110	4S600W	1	60.42













Made with Wavin Recycore Technology™
50% RECYCLED RAW MATERIAL

WC connectors – Easy-fit

Description		Nom dia inch	Cat no	Pack qty	Price £ per piece
Easy-Fit Pan Connectors		4in	WC004W	1	30.33
	Style 1 – Offset	4in	WC204W	1	37.00
	Style 90°	4in	WC904W	1	43.23
	Straight Extension Piece	4in	WC404W	1	37.07

Wavin OsmaSoil







Ancillaries







Description		Nom dia mm	Cat no	Pack qty	Price £ per piece
Terminal Fittings					
	Balloon Grating	82	3S302B	5	22.83
		82	3S302G	5	22.83
		110	4S302B	5	17.38
		110	4S302G	5	17.38
		110	4S302W	5	17.38
		160	6S302G	1	65.20
	Weathering Collar	82	3S300B	5	26.05
		82	3S300G	5	27.57
		110	4S300B	5	24.30
		110	4S300G	5	24.30
		110	4S300W	5	24.30
	SW/S Vent Cowl				
	♥	110	4S310B	1	87.79
	♥	110	4S310G	1	87.79
	♥	110	4S310W	1	87.79
	Flexible Vent Pipe – connects to ridge tile adaptor. Length 500mm	110	4S308B	1	212.25
Air Admittance Valves					
	OsmaVent 40 Air Admittance Valve – fits 1¼" / 32mm and 1½" / 40mm pipe	40	4S303W	1	131.55
	OsmaVent Air Admittance Valve – can also be adapted to fit 82mm soil	110	4S304W	1	297.30
	Domestic Air Admittance Valve All	110	4S306G	1	193.06
Pipe Flashings					
	VariPitch Pipe Flashing – 400mm x 400mm – for flat roofs		4S281G	1	236.45
	– 450mm x 450mm – for pitched roofs		4S283G	1	227.75
Roof Outlets					
	SW/S Domed Roof Outlet	82	3S414G	1	220.91
		110	4S414G	1	245.08
Rainwater Hopper and Shoe					
	Hopper Head	82	3S530B	1	176.67
		110	4S326B	5	148.64
		110	4S326G	5	148.64
	S/S Rainwater Pipe Shoe	82	3S288B	5	84.39
		110	4S288B	1	125.95
		110	4S288G	1	125.95

Description	Nom dia mm	Cat no	Pack qty	Price £ per piece
 <p>Cleaners, Solvent Cements, Lubricants Degreasing Cleaner No.1 – 250ml can</p>	–	4S380G	10	31.24
 <p>Solvent Cement No. 2 – 125ml can</p>	–	4S383G	10	36.20
<p>– 250ml can</p>  <p>– 500ml can</p>	–	4S384G	10	48.73
<p>– 500ml can</p>  <p>OSMA Solvent Cement No.2 400g POLYURETHANE ABB & PACE COMPATIBLE WITH WATER</p>	–	4S385G	10	106.07
 <p>Solvent Cement Filler – 140ml tube</p>	–	4S394G	5	51.34
 <p>Silicone Lubricant – 50g tube</p>	–	4S391G	5	40.66
 <p>Silicone Lubricant Spray – 400ml can</p>	–	4S392	1	70.80

Wavin OsmaWeld









ABS Solvent Weld waste









Description		Nom dia mm	Cat no	Pack qty	Price £ per piece	
Pipe						
	P/E Pipe – 3.0m					
	▽	32	4Z073B	10	28.95	
	▽	32	4Z073W	10	28.95	
	▽	40	5Z073B	10	35.76	
	▽	40	5Z073W	10	35.76	
	▽	50	2Z073B	10	45.87	
	P/E Pipe – 4.0m					
	▽	32	4Z074G	10	38.59	
	▽	40	5Z074G	10	47.60	
	▽	50	2Z074G	10	61.15	
	Bracket					
		Pipe Bracket				
▽		32	4Z081B	30	1.93	
▽		32	4Z081G	30	1.93	
▽		32	4Z081W	30	1.93	
▽		40	5Z081B	30	1.94	
▽		40	5Z081G	30	1.94	
▽		40	5Z081W	30	1.94	
▽		50	2Z081B	20	3.98	
▽		50	2Z081G	10	3.98	
▽	50	2Z081W	10	3.98		
Sockets						
	Double Socket					
	▽	32	4Z104B	20	5.45	
	▽	32	4Z104G	10	5.45	
	▽	32	4Z104W	20	5.45	
	▽	40	5Z104B	30	5.60	
	▽	40	5Z104G	30	5.60	
	▽	40	5Z104W	30	5.60	
	▽	50	2Z104B	10	11.19	
	▽	50	2Z104G	5	11.19	
▽	50	2Z104W	5	11.19		
	Expansion Socket – with solvent socket tail					
	▽	32	4Z124G	10	11.77	
	▽	32	4Z124W	10	11.77	
	▽	40	5Z124G	10	11.19	
	▽	40	5Z124W	10	11.19	
	▽	50	2Z124W	5	19.44	
Bends						
	Knuckle Bend – 90°					
	▽	32	4Z160B	10	7.26	
	▽	32	4Z160G	10	7.26	
	▽	32	4Z160W	10	7.26	
	▽	40	5Z160B	20	8.59	
	▽	40	5Z160G	20	8.59	
	▽	40	5Z160W	20	8.59	
	▽	50	2Z160B	10	13.45	
	▽	50	2Z160G	5	13.45	
▽	50	2Z160W	5	13.45		

Description		Nom dia mm	Cat no	Pack qty	Price £ per piece
	Spigot Bend – 90°	32	4Z260B	15	9.90
	▽	32	4Z260G	15	9.90
	▽	32	4Z260W	15	9.90
	▽	40	5Z260B	15	9.61
	▽	40	5Z260G	15	9.61
	▽	40	5Z260W	15	9.61
	▽	50	2Z260B	10	12.20
	▽	50	2Z260G	10	12.20
	▽	50	2Z260W	10	12.20
	Bend – 87.5°	32	4Z161B	10	7.63
	▽	32	4Z161G	10	7.63
	▽	32	4Z161W	25	7.63
	▽	40	5Z161B	10	9.12
	▽	40	5Z161G	10	9.12
	▽	40	5Z161W	10	9.12
	▽	50	2Z161B	5	14.25
	▽	50	2Z161G	5	14.25
	▽	50	2Z161W	5	14.25
	Bend – 45°	32	4Z163B	20	6.83
	▽	32	4Z163G	20	6.83
	▽	32	4Z163W	20	6.83
	▽	40	5Z163B	20	7.63
	▽	40	5Z163G	20	7.63
	▽	40	5Z163W	20	7.63
	▽	50	2Z163B	10	14.59
	▽	50	2Z163G	5	14.59
	▽	50	2Z163W	5	14.59
	Bend – 45° – male and female	32	4Z263B	5	5.81
	▽	32	4Z263W	5	5.81
	▽	40	5Z263B	10	6.75
	▽	40	5Z263G	10	6.75
	▽	40	5Z263W	10	6.75
	Long Tail Bend – 87.5°	50	2Z359G	5	22.73
Tees					
	Tee – 87.5°	32	4Z190B	10	9.05
	▽	32	4Z190G	10	9.05
	▽	32	4Z190W	10	9.05
	▽	40	5Z190B	5	9.54
	▽	40	5Z190G	5	9.54
	▽	40	5Z190W	5	9.54
	▽	50	2Z190B	10	19.64
	▽	50	2Z190G	5	19.64
	▽	50	2Z190W	5	19.64

Wavin OsmaWeld







ABS Solvent Weld waste







	Description	Nom dia mm	Cat no	Pack qty	Price £ per piece
	Tee – 45°				
	♥	32	4Z210W	10	14.33
	♥	40	5Z210B	5	17.43
	♥	40	5Z210G	5	17.43
	♥	40	5Z210W	5	17.43
	♥	50	2Z210B	5	25.44
	♥	50	2Z210G	5	25.44
	Cross Tee				
	Cross – 87.5°				
	♥	40	5Z230W	5	30.72
	♥	50	2Z230W	5	46.51
	Plug				
	Access Plug				
	♥	32	4Z292B	10	7.75
	♥	32	4Z292G	5	7.75
	♥	32	4Z292W	5	7.75
	♥	40	5Z292B	15	8.15
	♥	40	5Z292G	15	8.15
	♥	40	5Z292W	15	8.15
	♥	50	2Z292B	5	14.42
♥	50	2Z292G	5	14.42	
♥	50	2Z292W	5	14.42	
	Connectors and Adaptors				
	Straight Adaptor – Push fit to solvent weld				
	♥	32	4Z120W	10	7.94
	♥	40	5Z120W	10	7.94
	Straight Tank Connector				
	♥	32	4Z185W	10	19.03
	♥	40	5Z185W	5	19.72
	Universal Connector – for BS EN 1329, 1451, 1455 and 1566 pipe				
	♥	32	4W102B	10	10.82
	♥	32	4W102G	10	10.82
	♥	32	4W102W	10	10.82
	♥	40	5W102B	5	10.82
	♥	40	5W102G	5	10.82
	♥	40	5W102W	5	10.82
	♥	50	2W102G	10	10.41
	Male Cap and Liner – male threaded component				
	♥	32	4Z363W	10	11.73
	♥	40	5Z363W	10	11.73
	Female Cap and Liner – female threaded component				
	♥	32	4Z364W	5	7.62
	♥	40	5Z364W	5	8.59
	Female Iron Connector – solvent weld socket and BSPT socket				
	♥	32	4Z127W	5	15.97
	♥	40	5Z127W	10	17.37

	Description	Nom dia mm	Cat no	Pack qty	Price £ per piece
	Male Iron Connector – SW/S and BSPT spigot				
	♠	32	4Z128W	5	15.11
	♠	40	5Z128W	10	15.97
	♠	50	2Z128W	5	19.91
Reducers					
	Socket Reducer – 2"/50mm x 1¼"/32mm	50	2Z088B	10	9.61
		50	2Z088G	5	9.61
		50	2Z088W	5	9.61
	Socket Reducer – 2"/50mm x 1½"/40mm	50	2Z086B	10	9.39
		50	2Z086G	5	9.39
		50	2Z086W	5	9.39
	Socket Reducer – 1½"/40mm x 1¼"/32mm	40	5Z455B	10	5.13
		40	5Z455G	10	5.13
		40	5Z455W	10	5.13
	Waste to Overflow Reducer – 32x21.5mm – solvent weld	32	1E344B	5	8.59
		32	1E344W	5	8.59
	– 40x21.5mm – solvent weld	40	1E346B	5	8.59
		40	1E346W	5	8.59
	Reducer to 21.5mm pipe – synthetic rubber	32	4Z343G	10	6.55
	Reducer to 35mm copper pipe – synthetic rubber	40	5Z344G	10	6.75
	Reducer – 2"/50mm x 1¼"/32mm – synthetic rubber	50	2Z347G	5	12.51
	Reducer to 42mm copper pipe – synthetic rubber	50	2Z349G	5	11.85
	Level Invert Reducer – 1½"/40mm x 1¼"/32mm	40	5Z085B	5	6.83
		40	5Z085G	5	6.83
		40	5Z085W	5	6.83
	Air Admittance Valve OsmaVent 40 Air Admittance Valve – fits 1¼" / 32mm and 1½" / 40mm pipe	40	4S303W	1	131.55

Wavin Osma Waste





PP Push-fit waste

Description		Nom dia mm	Cat no	Pack qty	Price £ per piece
	Pipe P/E Pipe – 3.0 metre				
	♥	32	4W073B	10	19.66
	♥	32	4W073G	10	19.66
	♥	32	4W073W	10	19.66
	♥	40	5W073B	10	22.76
	♥	40	5W073G	10	22.76
	♥	40	5W073W	10	22.76
	♥	50	2W073G	5	38.26
♥	50	2W073W	5	38.26	
	Bracket Pipe Bracket				
	♥	32	4W081B	30	1.73
	♥	32	4W081G	30	1.73
	♥	32	4W081W	30	1.73
	♥	40	5W081B	30	1.64
	♥	40	5W081G	30	1.64
	♥	40	5W081W	30	1.64
	♥	50	2W081G	20	2.85
♥	50	2W081W	20	2.85	
	Socket Double Socket				
	♥	32	4W105B	15	5.66
	♥	32	4W105G	15	5.66
	♥	32	4W105W	15	5.66
	♥	40	5W105B	15	6.04
	♥	40	5W105G	15	6.04
	♥	40	5W105W	15	6.04
	♥	50	2W105G	5	10.24
♥	50	2W105W	5	10.24	
	Bends Knuckle Bend – 90°				
	♥	32	4W160B	10	5.24
	♥	32	4W160G	10	5.24
	♥	32	4W160W	10	5.24
	♥	40	5W160B	30	5.25
	♥	40	5W160G	30	5.25
	♥	40	5W160W	30	5.25
	♥	50	2W160G	5	10.24
♥	50	2W160W	5	10.24	
	Bend – 87.5°				
	♥	32	4W161B	10	5.66
	♥	32	4W161G	10	5.66
	♥	32	4W161W	10	5.66
	♥	40	5W161B	10	5.66
	♥	40	5W161W	10	5.66
	Bend – 45°				
	♥	32	4W163B	15	5.66
	♥	32	4W163G	15	5.66
	♥	32	4W163W	15	5.66
	♥	40	5W163B	20	5.24
	♥	40	5W163G	20	5.24
	♥	40	5W163W	20	5.24
	♥	50	2W163G	5	10.82
♥	50	2W163W	5	10.82	

Description		Nom dia mm	Cat no	Pack qty	Price £ per piece	
	Spigot Bend – 30°	32	4W166B	10	5.24	
	▽	32	4W166W	10	5.24	
	▽	40	5W166B	5	5.24	
	▽	40	5W166G	5	5.24	
	▽	40	5W166W	5	5.24	
	Spigot Bend – 90°	32	4W260B	10	6.04	
	▽	32	4W260G	10	6.04	
	▽	32	4W260W	10	6.04	
	▽	40	5W260B	10	6.04	
	▽	40	5W260G	10	6.04	
	▽	40	5W260W	10	6.04	
	▽	50	2W260W	5	10.00	
	Tee					
	Tee – 87.5°	32	4W190B	15	6.04	
	▽	32	4W190G	15	6.04	
	▽	32	4W190W	15	6.04	
	▽	40	5W190B	10	5.25	
	▽	40	5W190G	10	5.25	
	▽	40	5W190W	10	5.25	
	▽	50	2W190G	5	10.00	
▽	50	2W190W	5	10.00		
	Plug					
	Access Plug	32	4W292B	5	5.66	
	▽	32	4W292G	5	5.66	
	▽	32	4W292W	5	5.66	
	▽	40	5W292B	5	5.24	
	▽	40	5W292G	5	5.24	
	▽	40	5W292W	5	5.24	
	▽	50	2W292G	10	10.24	
▽	50	2W292W	10	10.24		
	Connectors and Adaptors					
	Universal Connector – for BS EN 1329, 1451, 1455 and 1566 pipe	32	4W102B	10	10.82	
	▽	32	4W102G	10	10.82	
	▽	32	4W102W	10	10.82	
	▽	40	5W102B	5	10.82	
	▽	40	5W102G	5	10.82	
	▽	40	5W102W	5	10.82	
	▽	50	2W102G	10	10.41	
		Tank Connector	40	5W185B	5	6.73
		▽				











Wavin Osma Waste

PP Push-fit waste

Description		Nom dia mm	Cat no	Pack qty	Price £ per piece
	Reducers Reducer – 1½" / 40mm x 1¼" / 32mm	40	5W084B	5	5.24
		40	5W084G	5	5.24
		40	5W084W	5	5.24
	Reducer – 2" / 50mm x 1¼" / 32mm	50	2W088G	5	8.94
		50	2W088W	5	8.94
	Reducer – 2" / 50mm x 1½" / 40mm	50	2W086G	5	10.00
		50	2W086W	5	10.00
	Reducer 32 x 21.5mm – Push-fit 40 x 21.5mm – Push-fit	32	1C344W	5	8.59
		40	1C346W	10	8.59
	Air Admittance Valve OsmaVent 40 Air Admittance Valve – fits 1¼" / 32mm and 1½" / 40mm pipe	40	4S303W	1	131.55









Wavin Osma Waste

Waste connectors and V-Joint traps

	Description	Nom dia mm	Cat no	Pack qty	Price £ per piece
	Flexible Waste Pipe Flexible Connector 450mm	40	5V901W	1	38.71
<hr/>					
	Bottle Traps				
	Bottle Trap – 38mm seal	32 40	4V809W 5V809W	1 1	31.44 41.76
	Bottle Trap – 75mm seal	32 40	4V812W 5V812W	1 1	39.16 47.91
	Anti-Syphon Bottle Trap – 75mm seal	32 40	4V814W 5V814W	1 1	52.19 65.88
	Resealing Bottle Trap – 75mm seal	32 40	4V816W 5V816W	1 1	52.19 65.89
	Adjustable Bottle Trap – 75mm seal	32 40	4V808W 5V808W	1 1	56.55 67.82
<hr/>					
	Tubular Traps				
	Tubular 'P' Trap – 75mm seal	32 40	4V801W 5V801W	1 1	29.98 34.10
	Tubular 'S' Trap – 75mm seal	32 40	4V803W 5V803W	1 1	36.68 54.95
	Adjustable Tubular 'P' Trap – 75mm seal	32 40	4V807W 5V807W	1 1	44.50 51.82
	Variform Trap – 75mm seal	32	4V804W	1	56.26
	Running 'P' Trap – 75mm seal	40	5V805W	1	60.17

Wavin Osma Waste



Waste connectors and V-Joint traps

	Description	Nom dia mm	Cat no	Pack qty	Price £ per piece
	Straight Through Trap – 75mm seal	32	4V825W	1	49.94
	Swivel 'P' Trap	32 40	4V811W 5V811W	10 10	26.70 28.99
Bath Traps					
	Bath Trap – 38mm seal	40	5V802W	1	39.88
	Bath Trap – shallow seal	32 40	4V806W 5V806W	1 1	32.58 27.04
	Bath Trap – 75mm seal	40	5V846W	1	50.60
	Bath Trap and Overflow – 75mm	40	5V848W	1	127.24
	Anti-Syphon Bath Trap	40	5V842W	1	55.53
	Bath Trap Extended Body – 60mm seal	40	5V860W	1	111.76
Shower Traps					
	Shower Trap – 19mm seal	40	5V823W	1	65.71

Description		Nom dia mm	Cat no	Pack qty	Price £ per piece
	Floor Gullies Floor Gully – c/w stainless steel tile and grid	50	2V502G	1	197.87
	Rubber Boss Adaptor * – 2" / 50 plastic or copper pipe	32 40 50	2S498B 2S499B 2S503B	10 10 10	16.45 16.45 17.17
	* for use with Osma 2V502 Floor Gully only				
	Stainless Steel Tile and Grid	-	2V414G	1	226.01
	Gully Funnel	-	2V418G	1	36.80
Washing Machine Sink Traps					
	Washing Machine Half Trap – 75mm seal	40	5V864W	1	60.41
	Adjustable Sink Trap – 75mm seal	40	5V869W	1	88.67
	Tubular Swivel Sink Trap – 40mm x 75mm (adjustable) with 19/22mm connection	40	5V407W	1	78.41
	Washing Machine Trap Kit Includes stand pipe and 2 brackets – 75mm seal	40	5V870W	1	51.65
	Washing Machine Tee Piece	40	5V871W	1	24.44
Ancillaries					
	Conversion Bend – 90° – for "P" Trap to convert to "S" Trap	32 40	4A830W 5A830W	20 10	9.48 10.17







Wavin Osma Waste

Condensate drainage

Description	Nom dia mm	Cat no	Pack qty	Price £ per piece
 <p>Connectors and Adaptors Tubular Swivel Trap – 40mm x 75mm (adjustable) with 21.5mm connection</p>	40	5V407W	1	78.41
 <p>Tubular Swivel Trap – 40mm x 75mm (adjustable) with 21.5mm connection and washing machine nozzle</p>	40	5V468W	1	89.94
 <p>Reducer – to 21.5mm pipe – synthetic rubber</p>	32	4Z343G	10	6.55



Wavin Osma Overflow

ABS / PVC-U Solvent Weld and PP Push-fit

	Description	Nom dia mm	Cat no	Pack qty	Price £ per piece
	Pipe P/E Pipe 3.0m Solvent 4.0m Push-fit	21.5 21.5	1E073W 1C074W	10 10	14.54 17.23
		Pipe Clip Solvent Push-fit	21.5	1E082W	10
	Double Socket Solvent Push-fit	21.5 21.5	1E104W 1C104W	30 10	5.96 5.73
		Bends Solvent – 90° Push-fit – 90°	21.5 21.5	1E160W 1C160W	10 30
Solvent – 45° Push-fit – 45°		21.5 21.5	1E166W 1C163W	10 20	7.07 6.81
Solvent – 25°		21.5	1E163W	10	7.07
	Tee Solvent – 90° Push-fit – 90°	21.5 21.5	1E190W 1C190W	5 5	7.62 7.99
		Tank Connectors Straight Tank Connector	21.5	1E129W	5
Bent Tank Connector 90° Solvent 90° Push-fit – cut off bend to convert to straight connector		21.5 21.5	1E139W 1C139W	5 5	10.36 10.43
	Reducers Reducer Solvent Weld 32x21.5mm 32x21.5mm 40x21.5mm 40x21.5mm	32 32 40 40	1E344B 1E344W 1E346B 1E346W	5 5 5 5	8.59 8.59 8.59 8.59
	Reducer Push-fit 32x21.5mm 40x21.5mm	32 40	1C344W 1C346W	5 10	8.59 8.59





Wavin Osma Overflow

ABS / PVC-U Solvent Weld and PP Push-fit

	Description	Nom dia mm	Cat no	Pack qty	Price £ per piece
	Cap and Lining Cap and Lining	21.5	1E156W	20	8.63
 	Adaptors Compression Fitting Adaptor – straight – for connection to BS 659 compression fitting and 23mm plastic overflow pipe. Compression Fitting Adaptor – 90° – for connection to BS 659 compression fitting and 23mm plastic overflow pipe.	21.5	1O158W	10	5.73
		21.5	1O159W	10	6.81



Wavin Osma Hep_vO Waste

Hygienic self-sealing waste valves – Polypropylene

	Description	Nom dia mm	Cat no	Pack qty	Price £ per piece
	Hep_vO Hygienic Self Sealing Waste Valve Hep _v O Valve	32 40	BV1 WH CV1 WH	10 10	43.34 43.34
	Hep_vO Knuckle Adaptor Hep _v O 87.5° Knuckle Adaptor	32 40	BV11 WH CV11 WH	10 10	10.94 10.94
	Hep_vO Running Adaptor For installing Hep _v O in a pipe run	32 40	BV3 WH CV3 WH	10 10	10.42 10.42
	Hep_vO Tundish Adaptor Hep _v O Tundish Adaptor Kit	32	BV1/21 WH	5	58.61

Wavin Osma Problem Solvers

Flexible Waste pipe

Description	Nom dia mm	Cat no	Pack qty	Price £ per piece	
 Flexible Waste Pipe – Smooth Bore – use with Spigot Connectors	3.0m	32	FBP3 WH	1	52.08
	3.0m	40	FCP3 WH	1	52.08
	6.0m	32	FBP6 WH	1	104.05
	6.0m	40	FCP6 WH	1	104.05
	Spigot Connectors – To Push-fit Waste				
	40	FCW6 WH	1	4.24	
	– To Solvent Weld Waste				
	32	FSBW6 WH	10	4.24	
	40	FSCW6 WH	10	4.24	

Flexible soil pipe

Description	Nom dia mm	Cat no	Pack qty	Price £ per piece	
 Flexible Pan Connector – Long Nominal length 280mm, nominal extended length 920mm	110	S170 WH	1	78.85	
	 – Short Nominal length 230mm, nominal extended length 670mm	110	S171 WH	1	75.58
		 – Extra Short Nominal length 195mm, nominal extended length 410mm	110	S172 WH	1

Condensate fitting

Description	Nom dia mm	Cat no	Pack qty	Price £ per piece
 Condensate Soakaway	21.5	S951 BL	1	57.11

Introduction to

Wavin Industrial and Commercial systems

Wavin's range of hot and cold plumbing and soil and waste systems have been designed for industrial and commercial applications.

The range includes Wavin AS+ acoustic soil, ideal for multi-residential projects and Wavin Compact soil for when space is at a premium.

Wavin's industrial and commercial range is backed up by dedicated expert support for specifiers and contractors.

Products are available in packs or as singles.

Key to abbreviations

B	Black	E	Olive
G	Grey	W	White

P/E – Pipe and fittings with both ends plain or with one plain end and one special end.

S/S – Pipe and fittings with one or more ring-seal or push-fit sockets, but always one plain or special end.

D/S – Fittings with ring-seal or push-fit sockets at all ends.

S/SW – Fittings with one or more ring-seal sockets but always one solvent socket.

SW/S – Fittings with one or more solvent sockets and one plain or special end.

D/SW – Fittings with solvent sockets at all ends.

Symbols

British Standards Kitemark

Identifies pipe and fittings manufactured under the BSI Kitemark Certification Scheme.

British Board of Agrément

BBA Logo Identifies non-Kitemarked fittings covered by a British Board of Agrément Certificate.

WRAS Water Regulations Advisory Scheme

Identifies pipe and fittings that are WRAS approved.

BRE Building Research Establishment

BRE identifies products that have attained BRE approval.

WIS Water Industry Specification

WIS identifies products that conform to Water Industry Specifications.

Acceptance

a) British Standards Institution

Wavin Systems comply, where applicable, with the requirements of the following British Standards:

BS EN 1566-1: 2000 – Plastic piping systems for soil and waste discharge (low and high temperature) within the building structure – Chlorinated poly (vinyl chloride) (PVC-C).

ABS pipe clips to BS EN 1455.

BS EN 1453-1:2000 – Plastics piping systems with structured-wall pipes for soil and waste discharge (low and high temperature) inside buildings. Unplasticized poly (vinyl chloride) (PVC-U). Specifications for pipes and the system.

BS EN 1329: 2001 – Plastics piping systems for soil and waste discharge (low and high temperature) within the building structure. Unplasticized poly(vinyl chloride) (PVC-U). Specifications for pipes, fittings and the system.

BS EN 1451-1: 2000 – Polypropylene waste pipe and fittings.

BS 6209: 1982 – Solvent cement for non pressure thermoplastics pipe systems.

BS EN 12380:2002 – Air admittance valves for drainage systems.

Requirements, test methods and evaluation of conformity.

b) British Board of Agrément

The system has been awarded the following certificates:

86/1643 110 and 40 Air Admittance Valves.

89/2174 110mm Adjustable Bends.

c) WRAS

Wavin Hep₂O is approved (certificate 1901900) – deemed safe for use in the supply of drinking water.

The Silicone Lubricant Spray has WRAS approval for use with potable water.







Important note:

Fittings of all product ranges must be ordered in their pack multiples as illustrated in price list.

Email: info@wavin.co.uk

Web: www.wavin.co.uk











Acoustic Soil system – Astolan® and PVC-U

Description		Nom dia mm	Cat no	Pack qty	Price £ per piece	
	Pipe					
	S/S Pipe					
	3.0m	50	3080063	123	31.50	
	0.15m	110	3080030	8	47.06	
	2.0m	110	3080034	1	71.56	
	2.7m	110	3080035	1	79.86	
	3.0m	110	3080036	1	91.50	
	0.15m	160	3080044	2	79.05	
3.0m	160	3080050	18	175.21		
	Couplers					
	Double Socket Coupler					
		50	3080016	18	9.92	
		110	3080012	8	32.61	
	160	3080014	6	62.93		
	Bends					
	Bends – 15°, 30°, 45°, 67°, 87°					
	15°	50	3079965	20	9.91	
	30°	50	3079966	18	9.91	
	45°	50	3079967	16	8.15	
	67°	50	3079968	12	9.91	
	87°	50	3079969	12	8.15	
	15°	110	3079950	8	31.67	
	30°	110	3079951	6	33.86	
	45°	110	3079952	8	35.73	
	67°	110	3079953	6	36.22	
	87°	110	3079954	4	37.15	
	15°	160	3079959	4	71.88	
	30°	160	3079960	4	73.86	
	45°	160	3079961	3	75.93	
	87°	160	3079962	3	81.52	
	Long Bend – 45°					
	45°	110	3080026	3	42.28	
	Branches					
	Branch – 45° and 87°					
	45°	50/50	3079996	6	17.79	
	87°	50/50	3079997	6	17.79	
	45°	110/50	3079982	4	39.75	
	87°	110/50	3079983	4	39.75	
	87°	110/70	3079985	4	44.45	
	45°	110/110	3079981	2	60.24	
	87°	110/110	3079980	4	108.02	
	45°	160/110	3079991	2	123.55	
	87°	160/110	3079992	2	123.55	
	45°	160/160	3079994	1	170.54	
		Double Branch – 87°				
			110/110 /110	3080010	2	202.10









Note: Wavin AS+ is available in light grey.

Wavin AS+

Acoustic Soil system – Astolan® and PVC-U











Description	Nom dia mm	Cat no	Pack qty	Price £ per piece
 Corner Branch – 87°	110/110 /110	3080008	2	291.43
 Shower Double Branch – 87°	110/110 /50	3080095	2	132.87
 Shower Double Branch – 87° left	110/110 /50	3080096	2	132.87
 Shower Double Branch – 87° right	110/110 /50	3080097	2	132.87
Soil & Waste Connections				
 S/S Soil Manifold	110	3065902	1	109.84
 All-Fit Reducer – 40:32mm – 1½" / 40 x 1¼" / 32 for use with 3065902	40	4Z124W*	10	11.77
 All-Fit Reduction Bend – 50:40mm – 2" / 50 x 1½" / 40 for use with 3065902	50	2S355W*	10	17.25
 All-Fit 90° Spigot Bend – 50mm – 2" / 50 for use with 3065902	50	2S356W*	5	28.39
 Repair Coupler	110 160	3080088 3080090	8 6	22.56 65.72
 Long Socket	50 110 160	3080023 3080019 3080021	5 8 3	13.72 26.33 64.29



Note: Wavin AS+ is available in light grey. * OAG discount applies.

Description		Nom dia mm	Cat no	Pack qty	Price £ per piece
	End Cap	50	3080106	24	9.21
		110	3080103	8	21.70
		160	3080105	8	79.82
	Reducer	110/50	3080078	6	22.60
		160/110	3080082	6	43.48
	Reducer	50/40	5Z124W	10	11.19
	Access Piece	50	3079917	6	35.98
		110	3079913	4	74.53
		160	3079915	2	176.86
Accessories					
	Wavin LKS-clamp	50	4065138	50	26.33
		110	4065141	20	26.33
		160	4065143	10	26.33
	Gasket EPDM	50	4065145	1	3.37
		110	4065188	1	2.81
		160	4065190	1	6.89
	Gasket NBR	50	4065192	1	3.37
		110	4025566	1	3.37
		160	4025568	1	3.37
	Wavin System Bracket	50	4066449	50	11.23
		110	4066452	25	16.05
		160	4066454	10	24.83
	Firecollar BM-R90	50	4026102	1	85.74
		110	4026106	1	127.91
		160	4026109	1	275.11

Wavin Solvent Soil











PVC-U Solvent Soil

	Description	Nom dia mm	Cat no	Pack qty	Price £ per piece
	Pipe P/E Pipe – 3.0m ♻️♻️	110	4S073E	2	134.63
	P/E Pipe – 4.0m ♻️♻️	110	4S074E	2	179.48
	S/S Pipe – 3.0m ♻️♻️	110	4S043E	2	139.94
	S/S Pipe – 4.0m ♻️♻️	160	6S043E	10	534.10
	S/S Pipe – 4.0m ♻️♻️	110	4S044E	2	193.46
Brackets					
	Pipe Bracket ♻️	110	4S082E	20	12.39
	Pipe Bracket ♻️	160	6S082E	1	45.43
	Socket Bracket ♻️	110	4S083E	5	16.51
Sockets					
	D/SW Double Socket ♻️	110	4S104E	10	27.23
	D/SW Double Socket ♻️	160	6S104E	1	65.99
	S/SW Single Socket ♻️	110	4S124E	5	28.36
	S/SW Single Socket ♻️	160	6S124E	5	97.06
	D/S Double Socket – for repairs ♻️	110	4S105E	1	58.81
	D/S Double Socket – for repairs ♻️	160	6S105E	1	165.69
	D/S Acoustic Socket ♻️	110	4S125E	5	43.08
Connector					
	S/S Connector to CI or clay drain socket ♻️	110	4S107E	5	49.33
Reducers					
	SW/S Reducer 110mm x 50mm ♻️	110	4S496E	5	56.49
	SW/S Reducer 160mm x 110mm ♻️	160	6S499E	1	106.50
	S/S Reducer 110mm x 50mm ♻️	110	4S096E	5	62.61
	S/S Reducer 110mm x 82mm ♻️	110	4S095E	5	57.43

	Description	Nom dia mm	Cat no	Pack qty	Price £ per piece
	Expansion Cap Expansion Cap – with integral ring–seal	110	4S416E	5	13.49
		160	6S416E	5	33.81
Bends					
	D/SW Bend 87.5° ♥ ♥	110	4S461E	5	73.83
		160	6S461E	1	194.51
	45° ♥ ♥	110	4S463E	5	73.75
		160	6S463E	1	199.22
	SW/S Bend 45° ♥	110	4S263E	5	79.88
	11.25° ♥	110	4S268E	5	77.07
	SW/S Long Tail Bend – 87.5° ♥	110	4S260E	5	84.84
	S/S Bend 87.5° ♥	110	4S161E	5	75.09
Offset Bends					
	SW/S Offset Bend – 67.5° (Bottom) ♥	110	4S435E	5	70.08
	S/SW Offset Bend – 67.5° (Top) ♥	110	4S440E	5	96.13
	D/SW Offset Bend – 67.5° (Top) ♥	110	4S450E	5	78.20
	Adjustable Bend S/S Adjustable Bend – 30° ▲	110	4S173E	1	94.34

Wavin Solvent Soil











PVC-U Solvent Soil

	Description	Nom dia mm	Cat no	Pack qty	Price £ per piece
	Boss Socket Adaptors SW/S Boss Adaptor (Solvent Weld) – for 1 1/4" / 32mm BS EN 1329, 1455 and 1566 pipe ▽	32	2S298E	10	13.79
	SW/S Boss Adaptor (Solvent Weld) – 1 1/2" / 40mm BS EN 1329, 1455 and 1566 pipe ▽	40	2S299E	10	12.73
	SW/S Boss Adaptor (Solvent Weld) – for 2" / 50mm BS EN 1329, 1455 and 1566 pipe ▽	50	2S403E	5	15.19
	Boss Adaptors S/S Boss Adaptor (Ring-Seal) – for 1 1/4" / 32 plastic or copper pipe ▽	32	2S398E	5	14.83
	S/S Boss Adaptor (Ring-Seal) – for 1 1/2" / 40 plastic or copper pipe ▽	40	2S399E	5	14.83
	S/S Boss Adaptor (Ring-Seal) – 2" / 50 plastic or copper pipe ▽	50	2S402E	5	19.12
	Branches D/SW Double Branch – 87.5° ▽	110	4S430E	1	261.28
	SW/S Corner Branch – 87.5° ▽	110	4S491E	1	462.41
	Access Branch D/SW Access Branch – 87.5° ▽	110	4S493E	1	198.09
	Single Branches D/SW Single Branch 45° ▽	110	4S410E	5	117.99
	SW/S Single Branch – 87.5° ▽	110	4S290E	5	104.44



	Description	Nom dia mm	Cat no	Pack qty	Price £ per piece
	DW/S Single Branch – 87.5° ▽	110	4S490E	5	104.38
	D/SW Unequal Single Branch – 87.5° ▽	160	6S498E	1	256.21
	D/SW Single Branch – 87.5° (No Bosses) ▽	160	6S490E	1	332.11
	Single 5-Boss Branch D/SW Single 5 Boss Branch – 87.5° ▽	110	4S495E	5	108.64
	Soil Manifolds 6 Boss Manifold	110	4S597E	1	118.08
	Manifolds Soil Manifold System ▽	110	4S595E	1	129.83
	All-Fit Reducer – 40:32mm – 1½" / 40 x 1¼" / 32 for use with 4S595E	40	4Z124W	10	11.77
	All-Fit Reduction Bend – 50:40mm – 2" / 50 x 1½" / 40 for use with 4S595E	50	2S355W	10	17.25
	All-Fit 90° Spigot Bend – 50mm – 2" / 50 for use with 4S595E	50	2S356W	5	28.39
	Bossed Pipes D/SW Short Bossed Pipe – NEW	110	4S588E	5	26.99
	D/SW Bossed Pipe – plain (four boss sockets) ▽	110	4S586E	5	36.10

Wavin Solvent Soil

PVC-U Solvent Soil







	Description	Nom dia mm	Cat no	Pack qty	Price £ per piece
	SW/S Bossed Pipe – plain (four boss sockets) ♥	110	4S585E	5	36.10
	D/SW Bossed Pipe (Solvent Weld) – for 1¼" / 32mm BS EN 1329, 1455 and 1566 pipe ♥	110	4S483E	5	32.43
	– 1½" / 40mm BS EN 1329, 1455 and 1566 pipe ♥	110	4S484E	5	32.43
	Strap Boss Strap Boss ♥	110	4S319E	5	25.18
	Access Fittings D/SW Access Bend – 87.5° ♥	110	4S469E	5	186.10
	D/SW 3-Boss Access Pipe – with screwed access and three boss sockets ♥	110	4S474E	5	123.74
	SW/S 3-Boss Access Pipe – with screwed access and three boss sockets ♥ ♥	110 160	4S574E 6S474E ^Δ	5 5	123.74 280.54
	Plugs P/E Access Plug ♥	110	4S292E	1	58.71
	SW/S Access Plug ♥	110	4S492E	5	73.95
	P/E Socket Plug – with one boss socket ♥	110	4S296E	5	41.38
	Terminal Fittings Balloon Grating	110	4S302E	5	17.38

Note: ^Δ = Available on a made to order basis. Please contact us regarding lead times.

	Description	Nom dia mm	Cat no	Pack qty	Price £ per piece
	Weathering Collar	110	4S300E	5	25.71
	SW/S Vent Cowl ▽	110	4S310E	1	87.79

Wavin Solvent Soil





Problem Solvers

	Description	Nom dia mm	Cat no	Pack qty	Price £ per piece
	Boss Adaptors Solvent Weld – 90°	40	2CS812SE	10	16.54
	▽	50	2CS813SE	10	23.53
	Solvent Weld – Straight	32	2CS814SE	10	13.79
	▽	40	2CS815SE	10	12.73
	▽	50	2CS816SE	10	15.19
	Push-fit – 90°	40	2CS802SE	10	23.53
	▽				
	Push-fit – Straight	32	2CS804SE	10	14.17
	▽	40	2CS805SE	10	14.17
	Double Branches D/SW Double 4-Boss Branch – 87.5°	110	4CS832SE	1	261.28
	▽				
	SW/S Double 4-Boss Branch – 87.5°	110	4CS834SE	1	261.28
	▽				
	Single Branch SW/S Single 5-Boss Branch – 87.5°	110	4CS895SE	5	108.64
	▽				
	Bossed Pipe D/SW Short 3-Boss Pipe	110	4CS588SE	1	26.99
	▽				

Note: The boss adaptors listed in this section are designed to fit the 4CS895SE; 4CS834SE; 4CS588SE and are not compatible with other bossed fittings in the Wavin Solvent Soil range.





Wavin Solvent Waste

PVC-C Solvent Weld waste

Description	Nom dia mm	Cat no	Pack qty	Price £ per piece
Pipe				
 P/E Pipe – 3.0m				
♥	32	4M073B	10	45.88
♥	32	4M073E	10	45.88
♥	32	4M073W	10	45.88
♥	40	5M073B	10	50.05
♥	40	5M073E	10	50.05
♥	40	5M073W	10	50.05
♥	50	2M073B	5	77.01
♥	50	2M073E	10	77.01
♥	50	2M073W	5	77.01
Bracket				
 Pipe Bracket				
♥	32	4M081E	40	1.92
♥	40	5M081E	35	1.95
♥	50	2M081E	20	3.98
♥	32	4Z081B	30	1.93
♥	32	4Z081G	30	1.93
♥	32	4Z081W	30	1.93
♥	40	5Z081B	30	1.94
♥	40	5Z081G	30	1.94
♥	40	5Z081W	30	1.94
♥	50	2Z081B	20	3.98
♥	50	2Z081G	10	3.98
♥	50	2Z081W	10	3.98
Sockets				
 Double Socket				
♥	32	4M104B	10	7.61
♥	32	4M104E	20	7.61
♥	32	4M104W	10	7.61
♥	40	5M104B	10	9.59
♥	40	5M104E	20	9.59
♥	40	5M104W	10	9.59
♥	50	2M104E	10	15.56
♥	50	2M104W	5	15.56
 Expansion Socket – with solvent socket tail				
♥	32	4M124E	10	16.07
♥	32	4M124W	10	16.07
♥	40	5M124E	10	16.79
♥	40	5M124W	10	16.79
♥	50	2M124E	5	30.00
♥	50	2M124W	5	30.00
Bends				
 Knuckle Bend – 90°				
♥	32	4M160B	30	11.37
♥	32	4M160E	30	11.37
♥	32	4M160W	30	11.37
♥	40	5M160B	30	13.38
♥	40	5M160E	30	13.38
♥	40	5M160W	30	13.38
♥	50	2M160B	5	23.89
♥	50	2M160E	5	23.89
♥	50	2M160W	5	23.89

Wavin Solvent Waste

PVC-C Solvent Weld waste





	Description	Nom dia mm	Cat no	Pack qty	Price £ per piece	
	Bend – 87.5°					
	♥	32	4M161B	10	13.91	
	♥	32	4M161E	10	13.91	
	♥	32	4M161W	10	13.91	
	♥	40	5M161B	40	16.79	
	♥	40	5M161E	40	16.79	
	♥	40	5M161W	40	16.79	
	♥	50	2M161B	5	23.34	
	♥	50	2M161E	5	23.34	
	♥	50	2M161W	5	23.34	
	Bend – 45°					
	♥	32	4M163B	10	10.56	
	♥	32	4M163E	10	10.56	
	♥	32	4M163W	10	10.56	
	♥	40	5M163B	20	11.86	
	♥	40	5M163E	20	11.86	
	♥	40	5M163W	20	11.86	
	♥	50	2M163B	5	20.06	
	♥	50	2M163E	5	20.06	
	♥	50	2M163W	5	20.06	
	Spigot Bend – 90°					
	♥	32	4M260E	5	14.67	
	♥	32	4M260W	5	14.67	
	♥	40	5M260E	10	17.72	
	♥	40	5M260W	10	17.72	
	♥	50	2M260B	5	26.34	
		♥	50	2M260E	5	26.34
		♥	50	2M260W	5	26.34
Tees						
	Tee – 87.5°					
	♥	32	4M190B	5	18.17	
	♥	32	4M190E	5	18.17	
	♥	32	4M190W	5	18.17	
	♥	40	5M190B	15	20.71	
	♥	40	5M190E	15	20.71	
	♥	40	5M190W	15	20.71	
	♥	50	2M190B	5	32.27	
	♥	50	2M190E	5	32.27	
	♥	50	2M190W	5	32.27	
Plug						
	Access Plug					
	♥	32	4M292B	5	11.25	
	♥	32	4M292E	5	11.25	
	♥	32	4M292W	5	11.25	
	♥	40	5M292B	5	11.05	
	♥	40	5M292E	5	11.05	
	♥	40	5M292W	5	11.05	
	♥	50	2M292B	5	19.19	
	♥	50	2M292E	5	19.19	
	♥	50	2M292W	5	19.19	

Description	Nom dia mm	Cat no	Pack qty	Price £ per piece
				
Reducers				
Reducer				
1½" / 40mm x 1¼" / 32mm				
♥	40	5M455B	10	7.07
♥	40	5M455E	10	7.07
♥	40	5M455W	10	7.07
2" / 50mm x 1¼" / 32mm				
♥	50	2M458B	5	13.35
♥	50	2M458E	5	13.35
♥	50	2M458W	5	13.35
2" / 50mm x 1½" / 40mm				
♥	50	2M456B	5	13.35
♥	50	2M456E	5	13.35
♥	50	2M456W	5	13.35







Note: For all push-fit ranges and ancillaries, please refer to the Osma section of the price list – see pages 44-54.

Wavin HDPE

Soil, waste and vent

Description	Nom dia mm	Cat no	Pack qty	Price £ per piece
Pipe				
 PE Pipe – 3.0m	110	3075609	1	54.13
 PE Pipe – 5.0m	40	3003465	1	25.63
	50	3003466	1	30.36
	56	3003477	1	35.75
	63	3003467	1	41.77
	75	3003468	1	48.30
	90	3003458	1	71.97
	110	3003459	1	90.21
	125	3003460	1	129.78
	160	3003461	1	202.80
	200	3003462	1	270.46
	250	3003463	1	430.82
	315	3003464	1	669.66
Reducers				
 Concentric Reducer	50/40	3084576	40	4.32
	56/50	3003820	20	4.32
	63/40	3003796 ^Δ	20	5.84
	63/50	3003797 ^Δ	20	5.84
	63/56	3003798	20	4.30
	75/50	3003800 ^Δ	20	6.33
	75/63	3003801 ^Δ	20	6.33
	90/50	3003803 ^Δ	20	6.51
	90/63	3003804 ^Δ	20	7.95
	90/75	3003805 ^Δ	20	7.95
	110/50	3003807 ^Δ	10	7.95
	110/56	3003858	10	7.88
	110/63	3003808	10	7.95
	110/75	3003809	10	7.95
	110/90	3003810	10	7.88
	125/63	3003812 ^Δ	20	12.66
	125/110	3003815	10	12.66
	160/110	3003816	5	14.05
	160/125	3003817 ^Δ	5	14.05
	200/160	3018808*	1	89.31
	250/200	3018809*	1	234.67
	315/250	3018810*	1	325.08
 Eccentric Reducer	50/40	3003821	20	4.66
	56/50	3003841	20	5.10
	63/40	3003822Q ^Δ	20	5.36
	63/50	3003823Q	20	5.36
	63/56	3003842Q	20	5.36
	75/40	3003824	20	6.15
	75/50	3003825	20	6.17
	75/56	3003843	20	6.16
	75/63	3003826	20	6.17
	90/50	3003827Q ^Δ	20	7.59
	90/63	3003828	20	8.26







Note: * = Segment Welded, Δ = Available on a made to order basis.
Please contact us regarding lead times.

Description	Nom dia mm	Cat no	Pack qty	Price £ per piece
 Eccentric Reducer – continued	90/75	3003829	20	8.30
	110/40	3003830	20	9.01
	110/50	3003831	20	8.79
	110/56	3003835	20	8.99
	110/63	3003832	20	9.01
	110/75	3003833	20	9.02
	110/90	3003834	20	8.98
	125/75	3003836Q ^Δ	10	14.95
	125/90	3003837Q	10	14.95
	125/110	3003838Q	10	14.95
	160/110	3003839	5	19.68
	160/125	3003840	5	19.69
 Eccentric Reducer – Long	200/110	3018811	5	144.37
	200/125	3018812	1	143.02
	200/160	3018813	1	143.02
	250/200	3070632*	1	227.94
	315/200	3014918*	1	325.08
	315/250	3003856*	1	323.72
Elbows				
 Elbow 15°	110	3017993	20	32.54
	160	3043453 ^Δ	1	54.91
	200	3043454 ^Δ	1	63.21
	250	3043455 ^Δ	1	103.62
	315	3043457 ^Δ	1	148.63
 Elbow 30°	110	3003576	20	33.04
	160	3003584	5	50.51
 Elbow 45°	40	3084563	10	3.53
	50	3084565	10	3.56
	56	3003597	20	4.23
	63	3003569	20	5.38
	75	3003572	20	6.81
	90	3003574	20	9.89
	110	3003577	25	9.68
	125	3003582	10	15.87
	160	3003585	5	41.24
	200	3018820	5	114.67
 Elbow 45° Long Tail	250	3018821*	1	187.47
	315	3018822* ^Δ	1	259.13
	110	3075824 ^Δ	6	11.91



Note: * = Segment welded, † = Swept type, Δ = Available on a made to order basis. Please contact us regarding lead times.

Wavin HDPE

Soil, waste and vent

Description	Nom dia mm	Cat no	Pack qty	Price £ per piece	
 Elbow 88.5°	40	3084564 [†]	10	3.55	
	50	3084566 [†]	10	4.74	
	56	3003598	20	4.74	
	63	3003570 [†]	20	5.93	
	75	3003573 [†]	20	8.41	
	90	3003575	20	11.99	
	110	3003579 [†]	20	12.97	
	125	3003583 [†]	10	20.83	
160	3003587 [†]	5	53.43		
Elbow 90° Welded	160	3003943	10	40.21	
 Elbow 90° Segment Welded	200	3018818 [*]	1	198.36	
	250	3017978 [*]	1	331.01	
	315	3018819 ^{*Δ}	1	483.08	
 Elbow 90° Extended	40	3084577	10	3.53	
	50	3084567	10	4.20	
	56	3003944	20	5.02	
	63	3003601 ^Δ	20	7.41	
	75	3003622	25	8.98	
	90	3003602	25	11.99	
	110	3003603	20	11.91	
	125	3003605 ^Δ	10	21.90	
 Airmix HDPE Airmix "sovent"	110	3003791 ^Δ	23	142.76	
	160	4042219 ^Δ	10	487.43	
 Branches Swept Branch 88.5°	110	3003792	10	19.78	
	 Double Branch 45°	90/50	3018005 ^Δ	10	42.72
		100/50	3003730 ^Δ	10	29.38
110/110		3003728	5	32.75	
 Branch 45°	40/40	3084570	20	8.65	
	50/40	3084574	25	8.98	
	50/50	3084572	25	8.91	
	56/50	3003725Q	20	8.17	
	56/56	3003724	20	8.48	
	63/40	3003635Q ^Δ	20	9.09	





Note: * = Segment welded, † = Swept type, Δ = Available on a made to order basis. Please contact us regarding lead times.

Description	Nom dia mm	Cat no	Pack qty	Price £ per piece
 Branch 45° – continued	63/50	3003637Q	20	9.60
	63/56	3003639Q	20	6.14
	63/63	3003633	20	9.36
	75/40	3003643Q	20	12.06
	75/50	3003645Q	20	11.45
	75/56	3003649	20	10.46
	76/63	3003647Q	20	7.99
	75/75	3003641	20	10.41
	90/40	3003654Q	10	15.66
	90/50	3003656Q	10	17.90
	90/63	3003658Q ^Δ	10	21.76
	90/75	3003660Q ^Δ	10	23.38
	90/90	3003651Q ^Δ	15	21.09
	110/40	3003664 ^Δ	10	17.37
	110/50	3003666	10	17.84
	110/56	3003674	10	17.29
	110/63	3003668	10	17.84
	110/75	3003670	10	18.02
	110/90	3003672Q ^Δ	10	21.94
	110/110	3003662	15	18.13
	125/50	3003678Q	10	32.38
	125/63	3003679 ^Δ	10	23.80
	125/75	3003681Q ^Δ	10	29.40
	125/90	3003683Q ^Δ	10	33.15
	125/110	3003685	10	23.80
	125/125	3003676 ^Δ	5	24.04
	160/110	3003688	5	82.78
	160/125	3003690 ^Δ	5	82.85
	160/160	4009725	5	81.69
	200/110	3070633*	5	178.14
	200/125	3018824Q ^Δ	1	193.08
	200/160	3070634*	5	186.04
	200/200	3070630*	5	267.11
	250/110	3003705*	1	298.18
250/125	3003707Q ^Δ	1	248.95	
250/160	3003709*	1	329.98	
250/200	3003710*	1	330.19	
250/250	3018826*	1	454.37	
315/110	3003723*	1	527.15	
315/125	3018827 ^Δ	1	390.03	
315/160	3018828*	1	526.81	
315/200	3003718*	1	551.70	
315/250	3003719*	1	558.54	
315/315	3018829*	1	666.41	
 Branch 88.5°	40/40	3084571	20	7.04
	50/40	3084575	20	8.99
	50/50	3084573	20	8.98
	56/50	3003726	20	8.98
	56/56	3003727	20	8.94
	63/50	3003638	20	9.29
	63/63	3003634 ^Δ	20	11.03
	75/50	3003646 ^Δ	20	10.98
	75/56	3003650	20	10.98







Note: * = Segment Welded, Δ = Available on a made to order basis. Please contact us regarding lead times.

Wavin HDPE

Soil, waste and vent









Description	Nom dia mm	Cat no	Pack qty	Price £ per piece
 Branch 88.5° – continued	75/63	3003648 ^Δ	20	13.99
	75/75	3003642	20	11.03
	90/40	3003655	10	14.05
	90/50	3003657	10	13.99
	90/63	3003659 ^Δ	10	13.99
	90/75	3003661 ^Δ	10	20.52
	90/90	3003652	10	13.96
	110/40	3003665	10	16.65
	110/50	3003667	10	16.65
	110/56	3003675	10	17.20
	110/63	3003669 ^Δ	10	17.20
	110/75	3003671	10	16.05
	110/90	3003673 ^Δ	10	17.20
	110/110	3003663	15	16.10
	125/63	3003680 ^Δ	10	23.95
	125/110	3003686 ^Δ	10	23.95
	125/125	3003677	10	23.95
	160/110	3003689	5	89.45
	160/125	3003691 ^Δ	5	68.37
	160/160	3003687	5	88.54
	200/110	3003698*	20	178.14
	200/125	3018830 ^Δ	1	178.14
	200/160	3003702*	1	177.38
	200/200	3018831*	1	177.38
	250/110	3018002*	1	253.50
	250/125	3018832 ^Δ	1	253.50
	250/160	3018003*	1	255.12
	250/200	3018833*	1	255.86
	250/250	3003704*	1	254.94
	315/110	3018834 ^{+Δ}	1	298.18
315/125	3003716 ^Δ	1	298.18	
315/160	3018835 ^{+Δ}	1	298.18	
315/200	3018836 ^{+Δ}	1	301.00	
315/250	3018837 ^{+Δ}	1	300.13	
315/315	3003713 ^{+Δ}	1	361.10	
 Boss Pipe Boss Pipe – Four Way Extended Spigot	110/56	3075823	6	51.38
Connectors and Adaptors Universal Connector ♡ ♡	40	5W102G •	5	10.82
	50	2W102G •	10	10.41
 Expansion Socket – with Solvent Socket Tail ♡	50	2Z124W •	5	19.44
 Long-Tail Bend – 87.5°	50	2Z359G •	5	22.73

* OAG discount applies.





Description	Nom dia mm	Cat no	Pack qty	Price £ per piece
 Rubber Boss Adaptor	56/32	4063088 ^A	1	12.80
	56/40	4063089 ^A	1	12.97
Brackets				
 Galvanised HDPE Bracket M10 Connection	40	4012113	10	5.17
	50	4012117	10	7.13
	56	4063090 ^A	1	7.31
	63	4012121 ^A	10	7.48
	75	4012125	10	7.78
	90	4012131	10	8.35
	110	4012137	10	9.14
	125	4012141	10	9.58
	160	4012146	10	10.66
 Bracket Insert	40	4012329	50	4.73
	50	4012331	50	9.48
	56	4063093 ^A	25	9.71
	63	4012333 ^A	50	11.37
	75	4012335	50	9.71
	90	4012337	50	9.99
	110	4012339	50	7.74
	125	4012341 ^A	50	10.52
	160	4012343	50	8.69
	200	4012345	20	37.10
	250	4023375	20	43.65
	315	4023376	20	49.77
 Galvanised HDPE Bracket	50 x 1/2"	4012118	10	8.30
	56 x 1/2"	4063094 ^A	50	9.09
	63 x 1/2"	4012122	10	9.09
	75 x 1/2"	4012126	10	9.17
	90 x 1/2"	4012132	10	10.50
	110 x 1/2"	4012138	10	10.61
	125 x 1/2"	4012142	10	10.46
	160 x 1/2"	4012147	10	12.97
	200 x 1"	4012151	10	38.66
	250 x 1"	4012155	10	39.19
	315 x 1"	4012159	10	45.63
	 Mounting Plate	M10	4063092 ^A	50
G 1/2"		4012326	50	6.77
 Fire Collar EFM	40	4063766	1	23.88
	50	4063767	1	23.88
	63	4063768	1	23.88
	75/78	4063769	1	30.36
	90	4063770 ^A	1	30.36
	110	4026438	1	32.61
	125	4026439 ^A	1	33.85
	160	4063772	1	51.01
	200	4026441 ^A	1	166.47
	250	4026442 ^A	1	346.11

Wavin HDPE

Soil, waste and vent

Description	Nom dia mm	Cat no	Pack qty	Price £ per piece
Spherical Branches				
 Spherical Branch, 2 Stubs Type A – 180°	110/110	3003755	5	60.48
Type B – 90°	110/110	3003756	5	59.99
 Spherical Branch, 3 Stubs Type E – 90°	110/110	3003776 ^Δ	5	73.02
 Spherical Branch, 4 Stubs Type F – 90°	110/110	3003777	5	81.06
Access Tees				
 Access Tee 45°	110/110	3003739	5	51.54
	125	3003741 ^Δ	5	64.48
	160/110	3003743	5	127.38
 Access Tee 88.5°	50	3003732 ^Δ	10	27.83
	63	3003734 ^Δ	10	35.44
	75/75	3003736	10	38.83
	90	3003738Q ^Δ	10	53.73
	110/110	3003740	10	53.43
	125	3018815Q ^Δ	10	47.33
	160/110	3070631*	5	126.32
	200/110	3017974*	1	210.09
250/110	3017975*	1	269.96	
315/110	3017976*	1	326.07	
Toilet Connectors				
 Wall Mounted Toilet Connector	90/90	3003550 ^Δ	10	32.64
	110/110	3003554 ^Δ	10	31.83
 Wall Mounted Toilet Connector Elbow 90° for hanging toilets	90/90	3003619 ^Δ	10	61.28
	110/90	3018007 ^Δ	10	61.06
	110/110	3003620 ^Δ	10	60.88
 Wall Mounted Double Toilet Connector Elbow 90°	110/110	3003621 ^Δ	5	123.01







Note: * = Segment Welded, Δ = Available on a made to order basis.
Please contact us regarding lead times.













Description	Nom dia mm	Cat no	Pack qty	Price £ per piece	
 Electro-fusion Coupler – Universal Type (WAVIDUO)	40	4081515	30	8.12	
	50	4081516	30	8.30	
	56	4081517	30	8.31	
	63	4081518	30	8.58	
	75	4081519	30	11.95	
	90	4081520	30	11.64	
	110	4081521	30	12.22	
	125	4081522	10	21.61	
	160	4081523	10	27.97	
	200	4061068	6	207.47	
	250	4064881	2	347.18	
	315	4064882	2	395.08	
	 Sockets, Caps and Flange Adaptors Push-fit Socket with Gasket and Cap	40/40	3084561	10	5.96
50/50		3084562	10	7.11	
56/56		3003493	20	7.94	
63/63		3003494 ^Δ	20	7.94	
75/75		3003495	20	11.29	
90/90		3003496 ^Δ	20	11.29	
110/110		3003497	20	14.33	
125/125		3003498 ^Δ	10	22.82	
160/160		3003499	18	45.01	
 Expansion Socket with Gasket and Cap		40/40	3003505	20	15.72
		50/50	3003506	20	15.53
		56/56	3018008	15	14.84
		63/63	3003507	20	18.57
	75/75	3003508	20	19.73	
	90/90	3003509	10	20.24	
	110/110	3003510	20	20.75	
	125/125	3003511 ^Δ	10	31.54	
	160/160	3003512	5	57.26	
	200/200	3003513*	15	265.40	
	250/250	3070629	1	389.93	
315/315	3003515	1	672.58		
 Complete Screw Connection	40	3003905 ^Δ	20	10.03	
	50	3003935 ^Δ	20	10.03	
	63	3003936 ^Δ	10	17.04	
	75	3003937 ^Δ	10	17.04	
	110	3003938 ^Δ	10	28.17	
 Complete Closing Cap	40	3003869	10	10.55	
	50	3003870	10	10.71	
	63	3003871 ^Δ	10	10.71	
	75	3082542	10	25.05	
	90	3003872 ^Δ	10	25.29	
	110	3003873	10	34.07	

Note: Δ = Available on a made to order basis. Please contact us regarding lead times.

Wavin HDPE

Soil, waste and vent

Description	Nom dia mm	Cat no	Pack qty	Price £ per piece
 Weld Cap	40	3003860	20	4.43
	50	3003861	20	3.77
	56	3003874	20	3.77
	63	3003862 ^Δ	20	3.77
	75	3003863	20	3.78
	90	3003865 ^Δ	20	4.78
	110	3003866	20	8.98
	125	3003867 ^Δ	10	11.20
 Protection Cap for pipe & fittings	160	3003868	10	36.21
	40	3018704 ^Δ	40	4.65
	50	3018705 ^Δ	40	6.06
	63	3018706 ^Δ	40	6.06
	75	3018707 ^Δ	40	7.04
	90	3018708	50	1.13
	110	3018709	40	1.27
	125	3018710 ^Δ	50	7.04
 Flange Cap	110	3072765	1	291.63
	160	3043503	1	291.63
	200	3043504	1	383.25
	250	3043505	1	398.78
	315	3043506	1	585.31
 Flange Adaptor	50	4025986 ^Δ	5	37.12
	63	4025988 ^Δ	5	51.71
	75	4025989 ^Δ	5	37.12
	110	4009748	5	41.28
	125	4009749 ^Δ	5	81.62
	160	4009750 ^Δ	5	70.29
	200	4009751 ^Δ	5	135.12
	250	4025992 ^Δ	1	232.61
315	3018031 ^Δ	1	396.62	
 Galvanised Steel Flange 1"	1"	4009793	20	8.37
 Brass Nut Connection	40x3/4"	3003908 ^Δ	20	12.15
	40x1"	3003910 ^Δ	20	12.15
	40x1 1/4"	3003912 ^Δ	20	12.15
	40x1 1/2"	3003913 ^Δ	20	12.15
	50x3/4"	3003917 ^Δ	20	28.66
	50x1 1/4"	3003921 ^Δ	20	28.66
	50x1 1/2"	3003924 ^Δ	20	28.66
	50x2"	3003927 ^Δ	20	28.66
63x2"	4009761 ^Δ	10	12.15	
 Shrink-on Socket with Seal	50	3003516 ^Δ	5	43.06
	63	3018026 ^Δ	5	43.06
	75	3018027 ^Δ	5	43.06
	90	3018028 ^Δ	5	43.06
	110	3003528 ^Δ	5	51.61
	125	3018029 ^Δ	5	51.61
	160	3018030 ^Δ	5	75.15
	200	3018025 ^Δ	1	89.85

Description		Nom dia mm	Cat no	Pack qty	Price £ per piece
	Accessories Electrofusion Welding Tool DUO 315 230v	–	4036330	1	3717.79
	Electrofusion Welding Tool WaviDUO 315 110v	–	4064999	1	7679.01
	Electrofusion Welding Tool Cable 40-160 Spare, for use with 4064999	–	4065001	1	380.50
	Electrofusion Welding Tool Cable 200-315 Spare, for use with 4064999	–	4065000	1	380.50
	Welding Mirror Complete with metal case Class X1, TP200	160	4011403	1	937.68
	Heat Reflector Butt-Welding Tool Maxi 315, 90-315mm	90-315	4011402 ^A	1	33657.66
	PE Pipe Cutter	50-125 110-160 200-315	4011390 4011393 4011396	1 1 1	697.70 713.43 3384.85
	HDPE Rotary Peelers for pipe 50mm for pipe 63mm for pipe 75mm for pipe 90mm for pipe 110mm for pipe 125mm for pipe 160mm	50 63 75 90 110 125 160	4042914 4024493 4024569 4024432 4024189 4024393 4024190	1 1 1 1 1 1 1	2225.84 2225.84 2663.05 2663.05 2663.05 2663.05 3100.30
	Replacement blade	–	4042915	1	230.53
	Other Processing Aids PE marker pen China Marker	–	4011453	12	20.71
	PE pipe scraper	–	4020757	10	72.60
	PE cleaner 0.7 litre bottle	–	4025509	12	42.54

Note: ^A = Available on a made to order basis. Please contact us regarding lead times.

Introduction to

Wavin Tigris – Press-Fit Plumbing System

Wavin Tigris Press-fit plumbing system is a multilayer, composite pipe, press-fit plumbing system designed for potable water, sanitary and heating applications. It is ideally suited for installation on commercial projects such as educational establishments, high rise residential and hotels. Widely specified and accorded a design award in Europe, Wavin Tigris is the proven and perfected system for commercial plumbing and heating projects and has a number of features and benefits,

All Wavin Tigris systems offer quick, simple and safe jointing method with no hot works permit required. The system is lightweight and corrosion resistant, with high resistance to scale build-up, stress-cracking, pressure and temperature. With a thermal expansion comparable with copper, Wavin Tigris is the perfect solution for commercial projects.

Wavin Tigris K5/M5 – the fitting that will blow you away!

NEW for 2023, Wavin have launched the Tigris K5 and M5 range of fittings in 16, 20, 25, 32 and 40mm diameter. These retain all the features of the K1 system, but with lots of additional benefits.

Key Features and benefits

- **Unique acoustic leak detection, any unpressed joints make a whistling noise so you can easily locate after installation**
- **Optiflow – designed for increased flow rate with up to 50% larger inner bore**
- **Flexible, multi-layer pipe requires minimal fittings reducing installation time and cost and improving flow rates**
- **Multi jaw – can be used with most available jaws meaning no new tools needed**
- **In4Sure technology ensuring full pipe insertion**
- **Guaranteed for 25 years and WRAS approved**
- **Defined leak function to reveal unpressed fittings when air testing not possible**

The range uses the same Tigris pipe and is fully compatible with the Tigris K1 system.

All tools in the range can be used with either system.

Find out more at wavin.co.uk/tigris-press-fit

Wavin Tigris K5







Press-fit plumbing system

Description	Nom dia mm	Cat no	Pack qty	Price £ per piece
Pipe				
 Pipe – Straight Lengths				
16mm x 2.0mm x 3m	16	3072958	25	12.87
16mm x 2.0mm x 5m	16	3061211	25	22.02
20mm x 2.25mm x 3m	20	3072989	18	18.43
20mm x 2.25mm x 5m	20	3061212	18	31.68
25mm x 2.5mm x 3m	25	3072990	10	28.06
25mm x 2.5mm x 5m	25	3061213	10	48.07
32mm x 3.0mm x 3m	32	3070827	6	35.13
32mm x 3.0mm x 5m	32	3041228	6	60.27
40mm x 4.0mm x 5m	40	3041229	4	97.19
 Pipe – Coils				
16mm x 2.0mm x 100m	16	3018297	1	347.00
16mm x 2.0mm x 200m	16	3018302	1	693.97
16mm x 2.0mm x 500m	16	3061202	1	1647.02
20mm x 2.25mm x 100m	20	3018299	1	490.62
25mm x 2.5mm x 50m	25	3018300	1	397.90
32mm x 3.0mm x 50m	32	3018301	1	545.47
 Pipe – Coil 9mm Pre-insulated				
32mm x 3.0mm x 25m GREY	32	3018804	1	539.96
 Pipe – Coils 9mm Pre-insulated				
16mm x 2.0mm x 50m RED	16	3004378	1	371.07
20mm x 2.25mm x 50m RED	20	3004379	1	494.36
25mm x 2.5mm x 25m RED	25	3071219	1	323.17
16mm x 2.0mm x 50m BLUE	16	3071220	1	371.07
20mm x 2.25mm x 50m BLUE	20	3071221	1	494.36
25mm x 2.5mm x 25m BLUE	25	3071222	1	344.98
 Pipe – Coils 13mm Pre-insulated				
16mm x 2.0mm x 50m RED	16	3004380	1	437.14
20mm x 2.25mm x 50m RED	20	3004381	1	545.16
25mm x 2.5mm x 25m RED	25	3070529	1	404.98
16mm x 2.0mm x 50m BLUE	16	3071224	1	437.14
20mm x 2.25mm x 50m BLUE	20	3071225	1	545.16
25mm x 2.5mm x 25m BLUE	25	3071226	1	404.98
Couplers				
 Straight Coupler				
16mm	16	3079754	10	4.55
20mm	20	3079755	10	5.93
25mm	25	3079756	10	8.90
32mm	32	3079757	5	15.49
40mm	40	3079758	3	24.67
 Reducing Coupler				
20 x 16mm	20	3079759	10	6.32
25 x 16mm	25	3079760	10	8.17
25 x 20mm	25	3079761	10	8.94
32 x 20mm	32	3079762	5	15.12
32 x 25mm	32	3079763	5	14.81
40 x 32mm	40	3079764	3	23.75

Wavin Tigris K5









Press-fit plumbing system







Description	Nom dia mm	Cat no	Pack qty	Price £ per piece	
Elbows					
 Elbow 45°	25	3079773	10	12.08	
	32	3079774	5	17.55	
	40	3079775	3	33.63	
 Elbow 90°	16	3079768	10	5.67	
	20	3079769	10	7.13	
	25	3079770	10	10.12	
	32	3079771	5	15.78	
	40	3079772	3	30.89	
 Elbow 90° – single male BSP thread	16mm x 1/2"	16	3079776	10	7.18
	20mm x 1/2"	20	3079777	10	8.75
	20mm x 3/4"	20	3079778	10	12.62
	25mm x 3/4"	25	3079779	10	14.07
	25mm x 1"	25	3079780	5	15.73
	32mm x 1"	32	3079781	5	25.10
 Elbow 90° – single female BSP thread	16mm x 1/2"	16	3079782	10	10.94
	20mm x 1/2"	20	3079783	10	13.86
	20mm x 3/4"	20	3079784	10	16.90
	25mm x 3/4"	25	3079785	10	18.90
	32mm x 1"	32	3079786	5	28.72
 Backplate Elbow – female BSP thread	16mm x 1/2"	16	3079854	10	14.90
	20mm x 1/2"	20	3079855	10	18.29
	20mm x 3/4"	20	3079856	10	18.90
 Toilet Tank Elbow	16mm x 1/2"	16	3083259	10	18.09
Tees					
 Equal Tee	16	3079811	10	7.71	
	20	3079812	10	11.03	
	25	3079813	5	15.85	
	32	3079814	5	27.01	
	40	3079815	2	44.21	
 One End Reduced Tee 20x20x16mm	20	3079824	10	10.10	
 Double End Reduced Tee	16x20x16mm	20	3079821	10	10.10
	20x25x20mm	25	3079826	5	13.80
	25x32x25mm	32	3079833	5	22.26

	Description	Nom dia mm	Cat no	Pack qty	Price £ per piece
	Branch Reduced Tee				
	20x16x20mm	20	3079823	10	10.10
	25x16x25mm	25	3079827	5	13.98
	25x20x25mm	25	3079828	5	15.22
	32x16x32mm	32	3079834	5	21.20
	32x20x32mm	32	3079835	5	22.64
	32x25x32mm	32	3079837	5	24.51
	40x25x40mm	40	3079839	2	34.51
	40x32x40mm	40	3079840	2	38.14
	Branch and One End Reduced Tee				
	20x16x16mm	20	3079822	10	10.10
	25x16x16mm	25	3079829	5	13.05
	25x20x20mm	25	3079825	5	14.01
	32x25x25mm	32	3079836	5	22.33
	40x32x32mm	40	3079842	3	33.95
	One Sided Female Thread Tee				
	16mm x 1/2" x 16mm	16	3079816	10	18.60
	20mm x 1/2" x 20mm	20	3079817	10	20.75
	20mm x 3/4" x 20mm	20	3079818	10	21.57
	25mm x 1/2" x 25mm	25	3079819	5	19.29
	25mm x 3/4" x 25mm	25	3079820	5	26.81
Connectors					
	Connector – single male BSP thread				
	16mm x 1/2"	16	3079798	10	5.69
	16mm x 3/4"	16	3079799	10	6.61
	20mm x 1/2"	20	3079800	10	7.26
	20mm x 3/4"	20	3079801	10	8.03
	25mm x 3/4"	25	3079802	10	9.18
	25mm x 1"	25	3079803	10	11.94
	32mm x 1"	32	3079804	5	17.50
	32mm x 1 1/4"	32	3079805	5	26.28
	40mm x 1 1/4"	40	3079806	3	28.83
	Connector – single female BSP thread				
	16mm x 1/2"	16	3079788	10	7.73
	16mm x 3/4"	16	3079789	5	7.87
	20mm x 1/2"	20	3079790	10	8.78
	20mm x 3/4"	20	3079791	10	11.35
	25mm x 3/4"	25	3079793	10	15.00
	32mm x 1"	32	3079796	5	25.34
	40mm x 1 1/4"	40	3079797	3	37.41
	End Cap				
		16	3079859	10	6.58
		20	3079860	10	7.30
		25	3079861	5	8.36

Wavin Tigris M5













Metal-body Press-fit plumbing system

Description	Nom dia mm	Cat no	Pack qty	Price £ per piece	
Couplers					
 Straight Coupler	16	4063971	10	7.78	
	20	4063972	10	9.72	
	25	4063974	5	15.38	
	32	4064166	5	23.32	
	40	4064167	5	54.09	
 Reducing Coupler	20 x 16mm	20	4064182	10	9.21
	25 x 20mm	25	4064185	5	13.36
	32 x 25mm	32	4064190	5	19.61
	40 x 32mm	40	4064193	5	45.46
	Elbows				
 Elbow 90°	16	4064199	10	8.53	
	20	4064200	10	11.49	
	25	4064202	5	19.10	
	32	4064204	5	28.74	
	40	4064205	5	88.23	
 Elbow 90° – single male BSP thread	16mm x 1/2"	16	4066001	10	11.37
	20mm x 1/2"	20	4066003	10	12.34
	20mm x 3/4"	20	4066004	10	16.58
	25mm x 3/4"	25	4066005	5	22.36
	32mm x 1"	32	4066007	5	36.14
	Elbow 90° – single female BSP thread				
 Elbow 90° – single female BSP thread	16mm x 1/2"	16	4066009	10	11.76
	20mm x 1/2"	20	4066011	10	12.82
	20mm x 3/4"	20	4066012	10	17.34
	25mm x 3/4"	25	4066013	5	24.00
	32mm x 1"	32	4066015	5	36.62
Tees					
 Equal Tee	16	4064323	10	12.08	
	20	4064324	10	17.57	
	25	4064326	5	27.04	
	32	4064328	5	41.33	
	40	4064329	5	107.66	
 Branch Reduced Tee	20x16x20mm	20	4064354	10	17.83
	25x16x25mm	25	4064361	5	25.69
	32x16x32mm	32	4064371	5	38.37
 One Sided Female Thread Tee	25mm x 3/4" x 25mm	25	4066095	5	38.16
	32mm x 1" x 32mm	32	4066097	5	60.42
	40mm x 1" x 40mm	40	4066099	5	108.70



	Description	Nom dia mm	Cat no	Pack qty	Price £ per piece
Connectors					
	Connector – single male BSP thread				
	16mm x 1/2"	16	4066041	5	7.53
	16mm x 3/8"	16	4064262	10	8.34
	16mm x 3/4"	16	4066042	10	9.16
	20mm x 1/2"	20	4066043	10	11.56
	20mm x 3/4"	20	4066044	10	14.94
	20mm x 1"	20	4066045	10	25.92
	25mm x 3/4"	25	4066046	5	17.15
	25mm x 1"	25	4064271	5	20.36
	32mm x 1"	32	4064273	5	20.96
	32mm x 1 1/4"	32	4064274	5	36.51
	40mm x 1 1/4"	40	4064276	5	41.33
	Connector – single female BSP thread				
	16mm x 1/2"	16	4066028	10	9.16
	16mm x 3/4"	16	4066029	10	18.31
	20mm x 1/2"	20	4066030	10	10.89
	20mm x 3/4"	20	4066031	5	15.22
	25mm x 3/4"	25	4066033	5	17.54
	25mm x 1"	25	4066034	5	26.40
	32mm x 1"	32	4066035	5	32.48
	Tap Connector – female BSP thread				
	16mm x 1/2"	16	4066072	10	9.16
	16mm x 3/4"	16	4066074	10	9.16
	20mm x 3/4"	20	4066076	10	10.17
	25mm x 3/4"	25	4066078	5	35.27
	25mm x 1"	25	4066079	5	21.76
	32mm x 1 1/4"	32	4066082	5	31.64
	40mm x 1 1/2"	40	4064315	3	42.12
	Tap connector elbows 90° – female BSP thread				
	16mm x 1/2" DRL	16	4066067	1	20.79
	20mm x 1/2" DRL	20	4066068	10	21.20
	Wall Flange				
	16mm x 1/2"	16	4066133	10	14.83
	Elbow 90° – Radiator Connector				
	16 x 15mm – 175mm long	16	4064235	10	17.30
	16 x 15mm – 300mm long	16	4064239	10	29.74

Wavin Tigris M5

Metal-body Press-fit plumbing system

Description	Nom dia mm	Cat no	Pack qty	Price £ per piece
Manifolds				
 Two Port Valved Manifold 3/4" with valves x2 ports 1/2"		4026692	2	32.33
 Three Port Valved Manifold 3/4" with valves x3 ports 1/2"		4026693	2	45.58
 Four Port Valved Manifold 3/4" with valves x4 ports 1/2"		4026694	2	63.18
 Manifold Adaptor 16 x 1/2"	16	4026699	10	6.36
 Two Port Manifold 3/4" x2 ports 1/2"		4026689	2	27.56
 Three Port Manifold 3/4" x3 ports 1/2"		4026690	2	36.04
 Four Port Manifold 3/4" x4 ports 1/2"		4026691	2	49.82
Manifold End Caps				
 3/4" BSP Female End Cap		HX97 GY•	5	4.73
 3/4" BSP Male End Cap		HX98 GY•	5	5.48
Manifold Bracket – Pair				
 for HX92T/15, HX93T/15 and HX94T/15		HX95A GR•	5	31.07
Accessories				
 Transition Fitting to Copper				
16 x 15mm	16	4065978	5	11.83
20 x 15mm	20	4065979	5	12.75
20 x 22mm	20	4065981	5	16.23
25 x 22mm	25	4065982	5	23.70
25 x 28mm	25	4065983	5	26.45
32 x 28mm	32	4067485	5	23.32
 Pressure Stopper				
	16	4013571	1	34.49
	20	4013572	1	34.49
	25	4013573	1	34.49

• PG9 discount applies.

	Description	Nom dia mm	Cat no	Pack qty	Price £ per piece
	Adaptor Fitting to Hep ₂ O				
	16 x 10mm	16	4064278	10	8.60
	16 x 15mm	16	4064277	10	9.03
	20 x 10mm	20	4064279	10	11.07
	20 x 22mm	20	4064280	10	16.15
	25 x 22mm	25	4064281	10	18.78
	25 x 28mm	25	4064282	10	24.73
	32 x 28mm	32	4064283	10	26.82
	Compression Adaptor				
	16mm x 1/2"	16	4055036	10	6.57



Wavin Tigris K1

Press-fit plumbing system

Description	Nom dia mm	Cat no	Pack qty	Price £ per piece
Pipe				
 Pipe – Straight Lengths				
50mm x 4.5mm x 5m	50	3004372	5	190.30
63mm x 6.0mm x 5m	63	3028271	3	310.44
75mm x 7.5mm x 5m	75	3053972	1	403.88
Couplers				
 Straight Coupler				
	50	3027832	2	36.50
	63	3027847	2	96.27
	75	3065639	2	122.39
 Reducing Coupler				
50 x 32mm	50	3027833	2	37.05
50 x 40mm	50	3027834	2	40.80
63 x 40mm	63	3027852	2	93.13
63 x 50mm	63	3027850	2	97.81
75 x 50mm	75	3065641	2	112.47
75 x 63mm	75	3065640	2	115.68
Elbows				
 Elbow 45°				
	50	3024668	2	52.81
	63	3027849	2	119.64
	75	3065642	2	130.35
 Elbow 90°				
	50	3024667	2	48.27
	63	3027848	2	108.79
	75	3065643	2	132.64
Tees				
 Equal Tee				
	50	3027829	2	69.08
	63	3027853	2	130.36
	75	3065644	2	183.34
 Branch Reduced Tee				
50 x 25 x 50mm	50	3027830	2	50.42
50 x 32 x 50mm	50	3027842	2	52.97
50 x 40 x 50mm	50	3027831	2	56.83
63 x 25 x 50mm	63	3027856	2	88.63
63 x 32 x 63mm	63	3027855	2	98.42
63 x 40 x 63mm	63	3027854	2	116.96
75 x 32 x 75mm	75	3065647	2	124.91
75 x 40 x 75mm	75	3065646	2	141.02
75 x 50 x 75mm	75	3065645	2	146.39
Connector				
 Connector – single male BSP thread				
50mm x 1 1/2"	50	3027837	2	42.38













Wavin Tigris M1

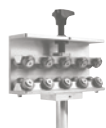









Metal-body Press-fit plumbing system

	Description	Nom dia mm	Cat no	Pack qty	Price £ per piece
Connectors					
	Connector – single male BSP thread				
	63mm x 2"	63	3090826	2	97.72
	75mm x 2½"	75	3090788	1	123.95
	Connector – single female BSP thread				
	50mm x 1½"	50	3090828	3	65.53
	63mm x 2"	63	3090829	2	103.16
	75mm x 2½"	75	4049179	2	167.83

Wavin Tigris

Press-fit plumbing system

Description	Nom dia mm	Cat no	Pack qty	Price £ per piece	
Accessories and Tools					
	Internal Bending Spring	16	4013553	1	41.24
		20	4013559	1	53.04
		25	4013562	1	56.81
	External Bending Spring	16	4023071	1	32.35
		20	4023073	1	35.35
		25	4023075	1	46.44
	Pipe Bending Pliers	16	4043224	1	242.69
	Pipe Bending Tool	20	4043225	1	259.68
	Pipe Bending Pliers 16/20/25mm	–	4023077	1	526.11
	Pipe Straightener 16/20/25mm	–	4013530	1	800.53
	Pipe Cutter 16mm-75mm	–	4053508	1	111.84
	Pipe Cutter with hold function 16/20/25mm	–	4036273	1	109.86
	Replacement Blade for 4036273	–	4037386	1	21.49
	Hand Press Tool 16-20mm	–	4013538	1	279.60
	Note: contains the tool only				
	Hand Tool Insert	16	4013542	1	95.68
		20	4013543	1	95.68
	Cordless Pressing Tool 16mm-40mm	–	4048906	1	2810.11
	Cordless Pressing Tool 16mm-75mm	–	4048907	1	4496.17
	Battery for 4048906	–	4066723	1	245.88

Description		Nom dia mm	Cat no	Pack qty	Price £ per piece
	Battery for 4048907	–	4066725	1	477.72
	Pressing Jaws – for use with 4048906	16	4046556	1	281.02
		20	4046557	1	281.02
		25	4046558	1	309.12
		32	4046559	1	309.12
		40	4046560	1	449.62
	Pressing Jaws – for use with 4048907	16	4046691	1	323.17
		20	4046694	1	323.17
		25	4046695	1	337.22
		32	4046756	1	337.22
		40	4046758	1	477.72
		50	4046759	1	505.82
		63	4035779	1	744.69
	Pressing Jaws – for use with 4048907 and 4053510	75	4053509	1	533.92
	Pressing Adaptor for 75mm Jaw – for use with 4048907 and 4053509	75	4053510	1	519.88
	Calibration Mandrel	16	4999998	1	94.02
		20	4999999	1	95.27
		25	4023364	1	100.15
		32	4023365	1	107.47
	Calibration Mandrel	40	4031987	1	184.36
		50	4031988	1	179.94
		63	4035780	1	266.51
		75	4053507	1	283.27
	Calibration Mandrel 16/20/25mm	–	3021196	1	114.23
	Handgrip Calibration Mandrel	–	3011162	1	53.14
		–	4036272	1	53.14
	Handgrip Calibration Mandrel	–	4036272	1	53.14
	Calibration Set 16mm-32mm	–	4013541	1	443.37

Introduction to

wavin Hep₂O

Wavin Hep₂O Flexible Push-fit Plumbing is the leading push-fit system with a pedigree of over 40 years and reputation for reliability.

Now Hep₂O has 2 systems to choose from – **Hep₂O Key and Hep₂O Keyless.**

Both systems benefit from:

- In4Sure joint recognition – tells you when the pipe is in.
- Secure demounting with the new HepKey system.
- New, improved SmartSleeve stays captive in the pipe.
- 50 year industry leading guarantee.
- Flexible pipe which comes off the coil straight.

Find out more about Hep₂O Keyless and get your sample here:



Wavin Hep₂O is Kitemarked to Class S of BS 7291, parts 1 and 2 and is manufactured within a Quality Management System which satisfies BS EN ISO 9002.

Wavin Hep₂O is also approved by **WRAS** (certificate 1901900) – deemed safe for use in the supply of drinking water.

Wavin Hep₂O Guarantee

As a result of its rigorous Quality Management programme, **Wavin Hep₂O** carries a 50 year guarantee against defect in materials or manufacturing of all its pipe and fittings.



Prices are for individual items within a pack unless otherwise stated.

Symbols

British Standards Kitemark

Identifies pipe and fittings which are manufactured under the BSI Kitemark Certification Scheme.

Important note: Fittings of all product ranges must be ordered in their pack multiples as illustrated in price list.



Wavin Hep₂O fittings are pre-lubricated, no additional lubrication is required.

DO NOT use any flux, jointing compound or non Wavin Hep₂O lubricant on Wavin Hep₂O fittings.

Email: info@hep2o.co.uk Web: www.hep2o.co.uk  [@hep2o](https://twitter.com/hep2o)

Wavin Hep₂O Push-fit Plumbing

Polybutylene pipe

Description	Nom dia mm	Cat no	Pack qty	Price £ per piece
				
Plumbing Pipe				
Coils – Barrier				
Please Note: Order pipe by unit (coil) not by metre				
25m ♡	10	HXX25/10W	1	76.81
50m ♡	10	HXX50/10W	1	151.30
100m ♡	10	HXX100/10W	1	298.06
10m ♡	15	HXX10/15W	1	36.17
25m ♡	15	HXX25/15W	1	90.35
50m ♡	15	HXX50/15W	1	178.82
80m ♡	15	HXX80/15W	1	286.12
100m ♡	15	HXX100/15W	1	352.12
120m ♡	15	HXX120/15W	1	422.56
10m ♡	22	HXX10/22W	1	70.57
25m ♡	22	HXX25/22W	1	176.38
50m ♡	22	HXX50/22W	1	349.25
10m ♡	28	HXX10/28W	1	95.14
25m ♡	28	HXX25/28W	1	237.83
50m ♡	28	HXX50/28W	1	473.41
				
Straight Lengths – Barrier				
3m ♡	15	HXX03/15W	10	11.33
3m ♡	22	HXX03/22W	10	22.14
3m ♡	28	HXX03/28W	10	30.37
6m ♡	15	HXX06/15W	40	23.36
6m ♡	22	HXX06/22W	20	45.85
6m ♡	28	HXX06/28W	12	62.52
				
Pipe in Pipe System				
Coil of Hep ₂ O Barrier Pipe in Blue or Red Conduit				
Please Note: Order pipe by unit (coil) not by metre				
50m ♡	10	HXXC5010 BU	1	314.25
50m ♡	10	HXXC5010 RD	1	314.25
50m ♡	15	HXXC5015 BU	1	361.33
50m ♡	15	HXXC5015 RD	1	361.33
50m ♡	22	HXXC5022 BU	1	555.81
50m ♡	22	HXXC5022 RD	1	555.81
25m ♡	28	HXXC2528 BU	1	457.58
25m ♡	28	HXXC2528 RD	1	457.58

Important Note:
Order pipe by unit (length) not by metre.
Cut lengths only available as pack quantities.

Wavin Hep₂O Push-fit Plumbing

Demountable fittings

Description		Nom dia mm	Cat no	Pack qty	Price £ per piece
	Straight Connector				
	♥ Key	10	HD1/10W	10	5.78
	♥ Key	15	HD1/15W	10	3.46
	♥ Key	22	HD1/22W	10	4.87
	♥ Key	28	HD1/28W	5	14.01
	♥ Keyless	10	KL1-10	10	5.78
	♥ Keyless	15	KL1-15	10	3.46
	♥ Keyless	22	KL1-22	10	4.87
	♥ Keyless	28	KL1-28	5	14.01
	Elbow 90°				
	♥ Key	10	HD5/10W	10	6.55
	♥ Key	15	HD5/15W	10	4.20
	♥ Key	22	HD5/22W	10	6.16
	♥ Key	28	HD5/28W	5	16.77
	♥ Keyless	10	KL5-10	10	6.55
	♥ Keyless	15	KL5-15	10	4.20
	♥ Keyless	22	KL5-22	10	6.16
	♥ Keyless	28	KL5-28	5	16.77
	Equal Tee				
	♥ Key	10	HD10/10W	10	8.09
	♥ Key	15	HD10/15W	10	5.90
	♥ Key	22	HD10/22W	10	8.09
	♥ Key	28	HD10/28W	5	23.14
	♥ Keyless	10	KL10-10	10	8.09
	♥ Keyless	15	KL10-15	10	5.90
	♥ Keyless	22	KL10-22	10	8.09
	♥ Keyless	28	KL10-28	5	23.14
	Demountable Stop-End				
	♥ Key	10	HD62/10W	10	5.13
	♥ Key	15	HD62/15W	10	4.59
	♥ Key	22	HD62/22W	10	5.78
	♥ Key	28	HD62/28W	5	9.62
	♥ Keyless	10	KL62-10	10	5.13
	♥ Keyless	15	KL62-15	10	4.59
	♥ Keyless	22	KL62-22	10	5.78
	♥ Keyless	28	KL62-28	5	9.62
	SmartSleeve Pipe Support				
	Key / Keyless	10	HX60/10W	20	0.82
	Key / Keyless	15	HX60/15W	50	0.83
	Key / Keyless	22	HX60/22W	50	1.08
	Key / Keyless	28	HX60/28W	20	1.60
	Spigot Elbow 90°				
	Single Socket				
	♥ Key	10	HD4/10W	5	6.55
	♥ Key	15	HD4/15W	5	4.42
	♥ Key	15x10	HD4A/15W	5	6.55
	♥ Key	22	HD4/22W	5	6.55

NEW – Keyless fittings are highlighted in blue + **BOLD** Cat Nos.

Important Note:

All fittings are pre-lubricated - no additional lubrication required.
Hep₂O fittings are fully compatible with Hep₂O and copper pipe.

Description	Nom dia mm	Cat no	Pack qty	Price £ per piece	
Spigot Elbow 90°					
Single Socket					
	▽ Keyless	10	KL4-10	5	6.55
	▽ Keyless	15	KL4-15	5	4.42
	▽ Keyless	15x10	KL4A-15	5	6.55
	▽ Keyless	22	KL4-22	5	6.55
Socket Reducer					
	15 x 10mm ▽ Key	15	HD2/15W	10	5.99
	22 x 15mm ▽ Key	22	HD2/22W	10	4.63
	28 x 22mm ▽ Key	28	HD2/28W	5	11.23
	15 x 10mm ▽ Keyless	10	KL2-15	10	5.99
	22 x 15mm ▽ Keyless	22	KL2-22	10	4.63
	28 x 22mm ▽ Keyless	28	KL2-28	5	11.23
Socket/Socket Reducer					
	15 x 10mm ▽ Key	15	HD3B/15W	10	10.89
	22 x 15mm ▽ Key	22	HD3B/22W	10	9.49
	22 x 10mm ▽ Key	22	HD3C/22W	10	10.89
	15 x 10mm ▽ Keyless	10	KL3B-15	10	10.89
	22 x 15mm ▽ Keyless	22	KL3B-22	10	9.49
	22 x 10mm ▽ Keyless	22	KL3C-22	10	10.89
Obtuse Bend 135° Single Socket					
	▽ Key	10	HD8/10W	5	7.07
	▽ Key	15	HD8/15W	5	4.91
	▽ Key	22	HD8/22W	5	7.07
	▽ Keyless	10	KL8-10	5	7.07
	▽ Keyless	15	KL8-15	5	4.91
	▽ Keyless	22	KL8-22	5	7.07
End Reduced Tee					
	22 x 15 x 22mm ▽ Key	22	HD12/22W	5	8.56
	28 x 22 x 28mm ▽ Key	28	HD12/28W	5	23.14
	22 x 15 x 22mm ▽ Keyless	22	KL12-22	5	8.56
	28 x 22 x 28mm ▽ Keyless	28	KL12-28	5	23.14
Double End Reduced Tee					
	10 x 10 x 15mm ▽ Key	15	HD18/15W	5	8.56
	10 x 10 x 22mm ▽ Key	22	HD18A/22W	5	9.05
	15 x 15 x 22mm ▽ Key	22	HD18/22W	5	8.56
	22 x 22 x 28mm ▽ Key	28	HD18/28W	5	23.14
	10 x 10 x 15mm ▽ Keyless	15	KL18-15	5	8.56
	15 x 15 x 22mm ▽ Keyless	22	KL18-22	5	8.56
	22 x 22 x 28mm ▽ Keyless	28	KL18-28	5	23.14





NEW – Keyless fittings are highlighted in blue + **BOLD** Cat Nos.

Wavin Hep₂O Push-fit Plumbing

Demountable fittings

Description	Nom dia mm	Cat no	Pack qty	Price £ per piece
 Branch Reduced Tee 15 x 15 x 10mm ♡ Key 22 x 22 x 10mm ♡ Key 22 x 22 x 15mm ♡ Key 28 x 28 x 15mm ♡ Key 28 x 28 x 22mm ♡ Key	15	HD13/15W	5	8.56
	22	HD13A/22W	5	8.56
	22	HD13/22W	5	8.56
	28	HD13A/28W	5	23.14
	28	HD13/28W	5	23.14
 15 x 15 x 10mm ♡ Keyless 22 x 22 x 10mm ♡ Keyless 22 x 22 x 15mm ♡ Keyless 28 x 28 x 15mm ♡ Keyless 28 x 28 x 22mm ♡ Keyless	15	KL13-15	5	8.56
	22	KL13A-22	5	8.56
	22	KL13-22	5	8.56
	28	KL13A-28	5	23.14
	28	KL13-28	5	23.14
 Branch Reduced Tee – Spigot 15 x 15 x 10mm ♡ Key 22 x 22 x 15mm ♡ Key	15	HD15/15W	5	8.56
	22	HD15/22W	5	8.56
 15 x 15 x 10mm ♡ Keyless 22 x 22 x 15mm ♡ Keyless	15	KL15-15	5	8.56
	22	KL15-22	5	8.56
 Branch and One End Reduced Tee 15 x 10 x 10mm ♡ Key 22 x 10 x 10mm ♡ Key 22 x 15 x 15mm ♡ Key 28 x 22 x 22mm ♡ Key	15	HD14/15W	5	8.56
	22	HD14A/22W	5	8.56
	22	HD14/22W	5	8.56
	28	HD14/28W	5	23.14
	 15 x 10 x 10mm ♡ Keyless 22 x 10 x 10mm ♡ Keyless 22 x 15 x 15mm ♡ Keyless 28 x 22 x 22mm ♡ Keyless	15	KL14-15	5
22		KL14A-22	5	8.56
22		KL14-22	5	8.56
28		KL14-28	5	23.14
 Blanking Peg For demountable Hep ₂ O fittings ♡ Key / Keyless ♡ Key / Keyless ♡ Key / Keyless ♡ Key / Keyless	10	HX44/10W	10	1.81
	15	HX44/15W	10	2.11
	22	HX44/22W	10	2.11
	28	HX44/28W	10	2.53
 Tank Connector with BSP tail & backnut (For cold water use only) BSP 1/2" Key BSP 3/4" Key BSP 1" (brass body) Key	15	HX20/15W	5	5.00
	22	HX20/22W	5	6.29
	28	HX20/28W	5	28.15
	 BSP 1/2" Keyless BSP 3/4" Keyless	15	KL20-15	5
22		KL20-22	5	6.29
 BSP 1" (brass body) Keyless	28	KL20-28HX	5	28.15

NEW – Keyless fittings are highlighted in blue + BOLD Cat Nos.

Description	Nom dia mm	Cat no	Pack qty	Price £ per piece	
 <p>Straight Tap Connector with brass nut and alternative rubber washer</p>	BSP 1/2" ♡ Key	15	HD25A/15W	10	6.01
	BSP 3/4" ♡ Key	15	HD25B/15W	5	7.11
	BSP 3/4" ♡ Key	22	HD25B/22W	5	7.70
	BSP 1/2" ♡ Keyless	15	KL25A-15	10	6.01
	BSP 3/4" ♡ Keyless	15	KL25B-15	5	7.11
	BSP 3/4" ♡ Keyless	22	KL25B-22	5	7.70
 <p>Bent Tap Connector with brass nut and alternative rubber washer</p>	BSP 1/2" ♡ Key	15	HD27/15W	5	6.64
	BSP 1/2" ♡ Keyless	15	KL27-15	5	6.64
 <p>Hand-Titan™ Tap Connector with rubber washer</p>	BSP 1/2" ♡ Key	10	HD26A/10W	5	6.11
	BSP 1/2" ♡ Key	15	HD26A/15W	5	5.08
	BSP 3/4" ♡ Key	15	HD26B/15W	5	6.11
	BSP 3/4" ♡ Key	22	HD26B/22W	5	6.60
	BSP 1/2" ♡ Keyless	10	KL26A-10	5	6.11
	BSP 1/2" ♡ Keyless	15	KL26A-15	5	5.08
	BSP 3/4" ♡ Keyless	15	KL26B-15	5	6.11
	BSP 3/4" ♡ Keyless	22	KL26B-22	5	6.60





NEW – Keyless fittings are highlighted in blue + **BOLD** Cat Nos.

Wavin Hep₂O Push-fit Plumbing

Flexible tap connectors – braided

Description	Nom dia mm	Cat no	Pack qty	Price £ per piece
Hep₂O x BSP Nut with brass nut and rubber washer				
 150mm BSP 1/2" Key	15	HD425A/15W	2	10.05
300mm BSP 1/2" Key	15	HD125A/15W	2	10.61
300mm BSP 3/4" Key	15	HD125B/15W	2	12.56
300mm BSP 3/4" Key	22	HD125B/22W	2	12.56
500mm BSP 1/2" Key	15	HD225A/15W	2	14.54
500mm BSP 3/4" Key	15	HD225B/15W	2	16.43
500mm BSP 3/4" Key	22	HD225B/22W	2	17.47
 150mm BSP 1/2" Keyless	15	KL425A-15	2	10.05
300mm BSP 1/2" Keyless	15	KL125A-15	2	10.61
300mm BSP 3/4" Keyless	15	KL125B-15	2	12.56
300mm BSP 3/4" Keyless	22	KL125B-22	2	12.56
500mm BSP 1/2" Keyless	15	KL225A-15	2	14.54
500mm BSP 3/4" Keyless	15	KL225B-15	2	16.43
500mm BSP 3/4" Keyless	22	KL225B-22	2	17.47
Hep₂O x Hep₂O				
 300mm 15mm x 15mm Key	15	HD125H/15W	2	12.47
300mm 22mm x 22mm Key	22	HD125H/22W	2	15.24
500mm 15mm x 15mm Key	15	HD225H/15W	2	18.26
500mm 22mm x 22mm Key	22	HD225H/22W	2	21.09
 300mm 15mm x 15mm Keyless	15	KL125H-15	2	12.47
300mm 22mm x 22mm Keyless	22	KL125H-22	2	15.24
500mm 15mm x 15mm Keyless	15	KL225H-15	2	18.26
500mm 22mm x 22mm Keyless	22	KL225H-22	2	21.09
Hep₂O x Elbow BSP Nut with brass nut and rubber washer				
 300mm Elbow BSP 1/2" Key	15	HD125D/15W	2	13.46
 300mm Elbow BSP 1/2" Keyless	15	KL125D-15	2	13.46

NEW – Keyless fittings are highlighted in blue + **BOLD** Cat Nos.











Description	Nom dia mm	Cat no	Pack qty	Price £ per piece
 <p>Hep₂O Brass Service Valve x BSP Nut with brass nut and rubber washer 300mm BSP 1/2" Key 500mm BSP 1/2" Key</p>	15	HD125E/15W	2	28.83
	15	HD225E/15W	2	31.55
 <p>300mm BSP 1/2" Keyless 500mm BSP 1/2" Keyless</p>	15	KL125E-15	2	28.83
	15	KL225E-15	2	31.55
 <p>Hep₂O Brass Service Valve (Handle) x BSP Nut with brass nut and rubber washer 300mm BSP 1/2" Key</p>	15	HD125EH/15W	2	28.83
	15	KL125EH-15	2	28.83
 <p>Hep₂O x Monobloc Mixers 300mm 15mm x M10 Key 300mm 15mm x M12 Key</p>	15	HD125F/15W •	Pair	18.98
	15	HD125G/15W •	Pair	18.98
 <p>300mm 15mm x M10 Keyless 300mm 15mm x M12 Keyless</p>	15	KL125F-15 •	Pair	18.98
	15	KL125G-15 •	Pair	18.98

• Sold and priced as a pair.











NEW – Keyless fittings are highlighted in blue + **BOLD** Cat Nos.

Wavin Hep₂O Push-fit Plumbing

Auxiliary fittings

	Description	Nom dia mm	Cat no	Pack qty	Price £ per piece
	Adaptor Male BSP/Hep ₂ O socket DZR Brass				
	BSP 1/2" ♡ Key	10	HX29/10W	10	9.88
	BSP 1/2" ♡ Key	15	HX29/15W	10	9.62
	BSP 3/4" ♡ Key	22	HX29/22W	10	13.82
	BSP 1" ♡ Key	28	HX29/28W	5	26.26
	BSP 1/2" ♡ Keyless	10	KLB29-10	10	9.88
	BSP 1/2" ♡ Keyless	15	KLB29-15	10	9.62
	BSP 3/4" ♡ Keyless	22	KLB29-22	10	13.82
	BSP 1" ♡ Keyless	28	KLB29-28	5	26.26
	Adaptor Female BSP/Hep ₂ O socket DZR Brass				
	BSP 1/2" ♡ Key	10	HX28/10W	10	9.88
	BSP 1/2" ♡ Key	15	HX28/15W	10	9.62
	BSP 3/4" ♡ Key	15	HX24/15W	10	13.82
	BSP 3/4" ♡ Key	22	HX28/22W	10	13.82
	BSP 1/2" ♡ Keyless	10	KLB28-10	10	9.88
	BSP 1/2" ♡ Keyless	15	KLB28-15	10	9.62
	BSP 3/4" ♡ Keyless	15	KLB24-15	10	13.82
	BSP 3/4" ♡ Keyless	22	KLB28-22	10	13.82
	BSP 1" ♡ Keyless	28	KLB28-28	5	27.16
	Adaptor Male BSP/Hep ₂ O spigot DZR Brass				
	BSP 1/2" ♡	15	HX31/15W	10	5.36
	BSP 3/4" ♡	22	HX31/22W	10	8.83
	BSP 1" ♡	28	HX31/28W	5	12.96
	Adaptor Female BSP/Hep ₂ O spigot DZR Brass				
	BSP 1/2" ♡	15	HX30/15W	10	5.25
	BSP 3/4" ♡	22	HX30/22W	10	8.83
	BSP 1" ♡	28	HX30/28W	5	12.96
	Draincock Brass 15mm spigot DZR Brass ♡	15	HX32/15 GY	10	9.62
	Adaptor Converts 1/2" tap connector to 3/4" DZR Brass BSP 1/2"x 3/4" ♡		HX39 GR	10	4.98
	Wall Plate Elbow Hep ₂ O				
	BSP 1/2" ♡ Key	15	HX6/15W	5	14.84
	BSP 3/4" ♡ Key	22	HX6/22W	5	16.13
	BSP 1/2" ♡ Keyless	15	KL6-15	5	14.84
	BSP 3/4" ♡ Keyless	22	KL6-22	5	16.13

NEW – Keyless fittings are highlighted in blue + **BOLD** Cat Nos.

Description	Nom dia mm	Cat no	Pack qty	Price £ per piece
 Ball Valve Plated Brass (suitable for central heating use) 15x15mm Key 22x22mm Key	15	HX22/15W	5	19.00
	22	HX22/22W	5	24.81
 15x15mm Keyless 22x22mm Keyless	15	KLB22-15	5	19.00
	22	KLB22-22	5	24.81
 Gate Valve DZR Brass (suitable for central heating use) 15mm Key 22mm Key	15	HX35/15W	5	15.05
	22	HX35/22W	5	21.43
 15mm Keyless 22mm Keyless	15	KLB35-15	5	15.05
	22	KLB35-22	5	21.43
 Stopcock – Cold Water fitted with Hep ₂ O ends 15mm Key 22mm Key	15	HX36/15W	5	26.90
	22	HX36/22W	5	28.93
 Stopcock – Cold Water Hep ₂ O to MDPE Conversion 22mm to 25mm MDPE	22	HX43/22W	5	35.34
 Shut-off Valve With hot/cold indicator insert NB: *SEE USAGE NOTE 15mm Key	15	HX37/15W	5	13.45
	15	HX38/15W	5	12.78
 Appliance Valve With hot/cold indicator insert NB: *SEE USAGE NOTE 15mm Key	15	HX38/15W	5	12.78
	15	HX18/15W	5	14.80
 Straight Service Valve With hot/cold indicator insert NB: *SEE USAGE NOTE 15mm Key	15	HX18/15W	5	14.80
	15	HX19/15W	5	15.48
 Angled Service Valve With hot/cold indicator insert NB: *SEE USAGE NOTE 15mm Key	15	HX19/15W	5	15.48

*For intermittent hot and cold water use up to a maximum of 65°C.
Not for use with central heating.

NEW – Keyless fittings are highlighted in blue + BOLD Cat Nos.

Wavin Hep₂O Push-fit Plumbing

Auxiliary fittings

	Description	Nom dia mm	Cat no	Pack qty	Price £ per piece
	Two Port Manifold 22x15mm ports Closed Spigot ♡ Key	22	HX88/22W	5	11.54
	22x15mm ports Closed Spigot ♡ Keyless	22	KL88-22	5	11.54
	Two Port Manifold 22x15mm ports All socket ♡ Key	22	HX88B/22W	5	11.93
	22x15mm ports All socket ♡ Keyless	22	KL88B-22	5	11.93
	Three Port Manifold 22x15mm ports Closed spigot ♡ Key	22	HX89/22W	5	15.50
	22x15mm ports Closed spigot ♡ Keyless	22	KL89-22	5	15.50
	Three Port Manifold 22x15mm ports All socket ♡ Key	22	HX89B/22W	5	16.07
	22x15mm ports All socket ♡ Keyless	22	KL89B-22	5	16.07
	Two Port Manifold 22x10mm ports All socket ♡ Key	22	HX92B/22W	5	12.62
	22x10mm ports All socket ♡ Keyless	22	KL92B-22	5	12.62
	Four Port Manifold 22x10mm ports All socket ♡ Key	22	HX94B/22W	5	16.07
	22x10mm ports All socket ♡ Keyless	22	KL94B-22	5	16.07

NEW – Keyless fittings are highlighted in blue + **BOLD** Cat Nos.

	Description	Nom dia mm	Cat no	Pack qty	Price £ per piece
	Two Port Manifold 22x10mm ports Socket and closed spigot ♡ Key	22	HX92/22W	5	11.54
	22x10mm ports Socket and closed spigot ♡ Keyless	22	KL92-22	5	11.54
	Four Port Manifold 22x10mm ports Socket and closed spigot ♡ Key	22	HX94/22W	5	15.50
	22x10mm ports Socket and closed spigot ♡ Keyless	22	KL94-22	5	15.50
	Four Port Manifold 22x10mm ports Socket and closed spigot, on one side ♡ Key	22	HX96/22W	5	17.72
	22x10mm ports Socket and closed spigot, on one side ♡ Keyless	22	KL96-22	5	17.72
	Four Port Manifold 22x10mm ports All socket, on one side ♡ Key	22	HX96B/22W	5	17.72
	22x10mm ports All socket, on one side ♡ Keyless	22	KL96B-22	5	17.72
	One Port Valved Manifold Plated Brass 3/4" BSP Male/female 22mm Hep2O port ♡ Key	22	HX91T/22W	1	32.28
	Plated Brass 3/4" BSP Male/female 22mm Hep2O port ♡ Keyless	22	KLB91T-22	1	32.28
	Two Port Valved Manifold Plated Brass 3/4" BSP Male/female 15mm Hep2O ports ♡ Key	15	HX92T/15W	1	54.21
	Plated Brass 3/4" BSP Male/female 15mm Hep2O ports ♡ Keyless	15	KLB92T-15	1	54.21

NEW – Keyless fittings are highlighted in blue + **BOLD** Cat Nos.

Wavin Hep₂O Push-fit Plumbing



Auxiliary fittings

Description	Nom dia mm	Cat no	Pack qty	Price £ per piece
 <p>Three Port Valved Manifold Plated Brass 3/4" BSP Male/female 15mm Hep₂O ports ♡ Key</p>	15	HX93T/15W	1	79.50
 <p>Plated Brass 3/4" BSP Male/female 15mm Hep₂O ports ♡ Keyless</p>	15	KLB93T-15	1	79.50
 <p>Four Port Valved Manifold Plated Brass 3/4" BSP male/female. 15mm Hep₂O ports ♡ Key</p>	15	HX94T/15W	1	108.54
 <p>Plated Brass 3/4" BSP male/female. 15mm Hep₂O ports ♡ Keyless</p>	15	KLB94T-15	1	108.54
 <p>Manifold End Caps 3/4" BSP Female End Cap 3/4" BSP Male End Cap</p>		HX97 GY HX98 GY	5 5	4.73 5.48
 <p>Manifold Bracket – Pair for HX92T/15, HX93T/15 and HX94T/15</p>		HX95A GR	1	31.07
 <p>Radiator Outlet Back Box Plastic (for stud wall)</p>		HX109 GY	5	5.00
 <p>Radiator Outlet Back Box Metal (for solid wall)</p>		HX110 GY	5	4.19
 <p>Radiator Outlet Cover with Flap For use with HX109 and HX110</p>		HX113 WH	5	10.98
 <p>Back Box Grommet For use with HX110</p>		HX112 GY	50	0.28

NEW – Keyless fittings are highlighted in blue + **BOLD** Cat Nos.



Wavin Hep₂O Push-fit Plumbing

Tools, fixings and accessories





	Description	Nom dia mm	Cat no	Pack qty	Price £ per piece
	HepKey Plus Demounting Tool	10	HX79/10W	10	0.52
		15	HX79/15W	10	0.60
		22	HX79/22W	10	0.60
		28	HX79/28W	10	0.68
	HepKey Demounting Tool	10	HX78/10W	10	0.47
		15	HX78/15W	10	0.52
		22	HX78/22W	10	0.52
		28	HX78/28W	10	0.59
	HepTool Demounting Tool 10/28mm 15/22mm	10	HX77/10W	10	3.16
		15	HX77/15W	10	2.59
	Cold Forming Bend Fixture Metal with passivate finish	15	HX75/15 GR	5	3.22
		22	HX75/22 GR	5	4.54
	Pipe Cutter – Scissor Type Standard		HD74 GR	1	26.72
	Pro Cutter		HD75 GR	1	65.87
	Pipe Cutter – Ratchet Type up to 28mm pipe		HD78 GR	1	67.38
	Hep₂O Joint Test Kit Hep ₂ O Joint Test Kit		HX81 GR	1	772.39
	Pipe Clips – Screw	15	HX85/15W	50	0.50
		22	HX85/22W	50	0.50
		28	HX85/28W	50	0.83
	Pipe Clip – Spacers	15	HX86/15W	20	0.37
		22	HX86/22W	20	0.50
	Pipe Clip Cable Type	10	HX65/10W	50	0.31
		15	HX65/15W	50	0.50
		22	HX65/22W	50	0.50
		28	HX65/28W	50	0.60

Wavin Hep₂O Push-fit Plumbing

Tools, fixings and accessories

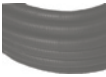
Description	Nom dia mm	Cat no	Pack qty	Price £ per piece
 Hep₂O Silicone Lubricant Spray 400ml aerosol can Hep ₂ O fittings		HX200	1	18.37
 Flat Tap Connector Washers – Rubber	15 22	HX58/15 GY HX58/22 GY	20 20	p/pack 7.06 p/pack 7.06
 Conical Tap Connector Washers – Rubber	15 22	HX57/15 GR HX57/22 GR	20 20	p/pack 7.06 p/pack 7.06

Conduit system

Description	Nom dia mm	Cat no	Pack qty	Price £ per piece
 Conduit Pipe 25.0m 50.0m 25.0m 50.0m	15 15 22 22	HXC25/15 BL HXC50/15 BL HXC25/22 BL HXC50/22 BL	1 1 1 1	56.16 112.41 70.28 139.81
 Conduit Junction Box		HX100 BL	1	9.32
 Conduit Junction Box Lid		HX104 BL	1	3.13
 Conduit Terminal	15	HX101/15W	2	12.97
 Terminal Back Plate		HX103 BL	1	2.59

Introduction to

Wavin Indoor Climate Solutions

Wavin Indoor Climate Solutions (ICS) provides a comprehensive range of solutions to create a healthier and more comfortable indoor environment. We offer a range of compatible products including underfloor heating, mechanical ventilation, heat interface units, and control systems for maximum usability and efficiency.

Wavin Calefa heat interface units provide 4-option bypass control, setting new standards for domestic hot water and heating, delivering on responsiveness, efficiency, and ease of installation.

Wavin Comfia provides a wide range of underfloor heating systems for new and existing floors. Our systems are easy to install and come with marketing leading guarantees.



Wavin Ventiza joins premium quality heat exchangers with extremely low power consumption, providing a range of solutions that matches performance to property size for maximum efficiency.

Wavin Sentio delivers optimum comfort and energy efficient methods to controlling the indoor climate of domestic and commercial buildings with a single control system to operate all Wavin ICS solutions.

Find out more at wavin.co.uk

Wavin Indoor Climate Solutions

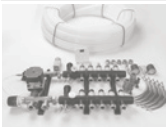
UFH – Comfia Packs

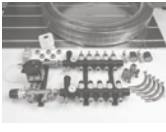
	Description	Cat no	Pack qty	Price £ per piece
	Pack type 1 – UFHC1			
	Single zone, screeded low temp with dial stat			
	12m ²	UFHC1-12	1	278.94
	15m ²	UFHC1-15	1	295.07
	20m ²	UFHC1-20	1	366.36
	30m ²	UFHC1-30	1	382.49
	Pack type 2 – UFHC2			
	Single zone, screeded high temp with dial stat			
	15m ²	UFHC2-15	1	609.40
	20m ²	UFHC2-20	1	625.54
	30m ²	UFHC2-30	1	696.83
	30m ²	UFHC2-40	1	712.96
	Pack type 6 – UFHC6			
	Multi zone, screeded, low temp with wireless controls			
	40m ² – 2 zone	UFHC6-40	1	995.89
	60m ² – 3 zone	UFHC6-60	1	1356.64
	80m ² – 4 zone	UFHC6-80	1	1699.87
	Pack type 8 – UFHC8			
	Retrofit 18mm low build board, 1 zone, high/low temp with dial stat			
	12m ²	UFHC8-12	1	954.55
	15m ²	UFHC8-15	1	1078.34
	20m ²	UFHC8-20	1	1239.59
	30m ²	UFHC8-30	1	1685.91

UFH – Polybutylene pipe







Description	Nom dia mm	Cat no	Pack qty	Price £ per piece	
 Polybutylene UFH pipe Coils Please Note: Order pipe by unit (coil) not by metre	50m	12	12CS050	1	74.86
	80m	12	12CS080	1	117.98
	100m	12	12CS100	1	147.48
	50m	16	16CS050	1	87.85
	80m	16	16CS080	1	144.44
	100m	16	16CS100	1	179.47
	120m	16	16CS120	1	208.83
	150m	16	16CS150	1	258.97
	200m	16	16CS200	1	358.94
	500m	16	16CS500	1	853.51
	100m	20	20CS100	1	219.32
	120m	20	20CS120	1	280.49
	140m	20	20CS140	1	327.24
	160m	20	20CS160	1	373.95
	180m	20	20CS180	1	420.70
	200m	20	20CS200	1	467.46

UFH – PE-RT 5 layer pipe



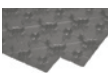





Description	Nom dia mm	Cat no	Pack qty	Price £ per piece	
 PE-RT 5 layer UFH pipe Coils Please Note: Order pipe by unit (coil) not by metre	100m	12	12CS910	1	36.46
	200m	12	12CS920	1	70.34
	600m	12	12CS960	1	208.41
	120m	16	16CS913	1	67.89
	240m	16	16CS925	1	144.29
	480m	16	16CS948	1	264.73
	600m	16	16CS960	1	332.08

Wavin Indoor Climate Solutions

UFH – Floor fixings and accessories





	Description	Nom dia mm	Cat no	Pack qty	Price £ per piece
	Staple System Staples 60mm for 16mm and 20mm Pipe	16/20	30CS301	300	0.07
	Staple Gun for 60mm staples		30CS305	1	320.47
	Clip Rail Universal Clip Rail for 16mm and 20mm pipe	16/20	30CS302	1	3.05
	System Plate 25mm System Plate for 16mm pipe 18mm System Plate for 12mm pipe	16	16CS303	18	11.71
	System Plate Tack Fastener	12	12CS303	16	9.20
	Edge Expansion Foam Edge Expansion Foam (25m x 150mm)		30CS306	25	0.38
	Edge Expansion Foam Edge Expansion Foam (25m x 150mm)		30CS304	1	26.34
	Bend Former Cold Formed Metal Bend for 12mm pipe for 16mm pipe for 20mm pipe for 16mm pipe (plastic)	12	12CS300	5	1.34
		16	16CS300	5	1.34
		20	20CS300	5	2.67
		16	4028869	1	0.83

UFH – Manifolds

Description	Nom dia mm	Cat no	Pack qty	Price £ per piece
Composite Manifold				
 Pre-Built Modular Manifolds				
2 Port		30CS502	1	153.12
3 Port		30CS503	1	174.14
4 Port		30CS504	1	203.53
5 Port		30CS505	1	231.63
6 Port		30CS506	1	255.58
7 Port		30CS507	1	284.10
8 Port		30CS508	1	313.12
9 Port		30CS509	1	340.56
10 Port		30CS510	1	369.52
11 Port		30CS511	1	398.49
12 Port		30CS512	1	419.97
 Composite Manifold 22mm Isolation Valves Pair	22	30CS513	2	36.20
 Composite Manifold 1" BSP Isolation Valves Pair	22	30CS554	2	39.92
 Composite Manifold Control Pack A Rated		30CS515	1	266.44
 Composite Manifold Flow Watch Thermostat		30CS516	1	23.42
 Temperature Pressure Gauge		30CS521	1	18.02
 Manifold Euroconus Adaptor for 12mm pipe	12	12CS501	2	5.13
for 16mm pipe	16	16CS501	2	5.83
for 16mm pipe (nickel plated)	16	16CS506	2	5.53
for 20mm pipe	20	20CS501	2	6.53
 UFH pipe connector 3/4" x 3/4"		16CS505	50	3.71



Wavin Indoor Climate Solutions

UFH – Manifolds

Description	Nom dia mm	Cat no	Pack qty	Price £ per piece
Stainless Steel Manifold				
 Stainless Manifold*				
2 port	25	30CS532	1	117.23
3 port	25	30CS533	1	139.15
4 port	25	30CS534	1	162.68
5 port	25	30CS535	1	190.86
6 port	25	30CS536	1	209.71
7 port	25	30CS537	1	232.13
8 port	25	30CS538	1	270.73
9 port	25	30CS539	1	298.13
10 port	25	30CS540	1	325.06
11 port	25	30CS541	1	358.32
12 port	25	30CS542	1	377.73
Stainless Steel Manifold Ancillaries				
 Stainless Steel Isolating Valves 1" Pair	25	30CS530	1	37.37
 Thermometer for Ball Valves		30CS543	1	4.36
 Coupling 1" Female – Female Stainless Pair	25	30CS545	1	26.71
 Actuator Adaptor Pair		30CS547	1	1.01

*Each stainless steel manifold requires the correct quantity of actuator adaptors (30CS547) and euroconus adaptors (12CS501, 16CS501 or 20CS501) depending on the actuator size and pipe being used.

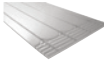
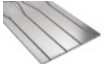

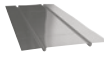







UFH – Panel Systems

Description	Nom dia mm	Cat no	Pack qty	Price £ per piece
 <p>Warmdeck UFH Panels Structural Chipboard 22mm 2.4 x 0.6m 150mm centres for 16mm pipe</p>	16	25CS348	1	58.58
 <p>Low-Build 18mm 1.2 x 0.6m 150mm centres for 12mm pipe, foil-faced</p>	12	12CS310	1	22.09
 <p>Highway Panel Low Build 18mm 1.2 x 0.6m 40mm centres for 12mm pipe, foil-faced</p>	12	25CS350	1	24.59
 <p>Cover panel 6mm cementitious 2.4 x 1.2m for 12mm pipe, foil-faced</p>		25CS349	1	66.98
 <p>Low-Build Panel Adhesive 12L = <math>46m^2</math></p>		12CS319	1	262.80
<p>UFH – Diffuser Plates</p>  <p>Double Diffuser Plate for 16mm pipe for 20mm pipe</p>	16 20	16CS307 20CS307	10 10	12.95 12.95

Wavin Indoor Climate Solutions



UFH – Control Systems

	Description	Nom dia mm	Cat no	Pack qty	Price £ per piece
	Sentio Controls Sentio Thermostats Wired Wireless Wireless with Infra-Red Floor Sensor		35CS400 35CS403 35CS402	1 1 1	93.94 96.87 123.10
	Sentio Sensors Wired Wireless		35CS401 35CS404	1 1	63.91 74.02
	Sensor Probe Remote/Floor Sensor Probe		35CS490	1	11.18
	Sensor Probe Cover		35CS489	1	11.18
	Sentio Control Centre 8 Zone Control Centre		35CS405	1	222.02
	Sentio Extension Unit 8 Way Extension Unit for use with 35CS405		35CS406	1	84.10
	Sentio Touch Screen LCD Touch Screen		35CS407	1	136.62
	Sentio Thermostat Frame		35CS408	1	6.92
	Sentio Smart Radiator Thermostat including M28 and M30 adaptors		35CS411	1	95.00









Description	Nom dia mm	Cat no	Pack qty	Price £ per piece
 <p>Whisper Controls KF600 8-Way Wiring Centre 230V</p>		35CS500	1	56.53
 <p>DT-430 Dial Thermostat 230V</p>		35CS501	1	25.18
 <p>ST-300 Programmable Thermostat 230V</p>		35CS503	1	42.40
 <p>MU-600 Wifi Thermostat 230V</p>		35CS504	1	59.36
 <p>MU-050 Touchscreen Wifi Stat</p>		35CS511	1	60.77
 <p>TP-200 floor sensor for programmable stats</p>		35CS505	1	7.07
 <p>TC-140 1 Channel Timeswitch</p>		35CS508	1	39.57
 <p>TC-140 2 Channel Timeswitch</p>		35CS509	1	42.40
 <p>TC-140 3 Channel Timeswitch</p>		35CS510	1	49.47
 <p>Ancillaries 24V Actuator for use with Sentio controls</p>		35CS499	1	21.63
 <p>230V Actuator for use with 230V controls</p>		35CS498	1	21.63

Wavin Indoor Climate Solutions

UFH – Manifold Cabinets

Description	Nom dia mm	Cat no	Pack qty	Price £ per piece
 <p>Surface mounted 2-4 port standard manifolds 5-8 port standard manifolds 9-12 port standard manifolds</p>		30CS548 30CS549 30CS550	1 1 1	55.86 60.62 67.07
 <p>In-wall mounted 2-4 port standard manifolds 5-8 port standard manifolds 9-12 port standard manifolds</p>		30CS551 30CS552 30CS553	1 1 1	61.85 65.95 70.57









UFH – Heat Interface Units

	Description	Nom dia mm	Cat no	Pack qty	Price £ per piece
	Calefa Calefa II V 26/26 V HIU Heat Interface Unit		40CS605	1	1681.36
	Calefa II V 40/26 V HIU Heat Interface Unit		40CS606	1	1708.34
	Calefa II V 60/40 V HIU Heat Interface Unit		40CS607	1	1786.47
	Calefa II V ITC 26/26 V HIU Heat Interface Unit		40CS608	1	1714.43
	Calefa II V ITC 40/26 V HIU Heat Interface Unit		40CS609	1	1741.41
	Calefa II V ITC 60/40 V HIU Heat Interface Unit		40CS610	1	1819.54
	Calefa Flushing Bypass		40CS601	1	151.95
	Calefa Frame Top Entry Kit 4 up, 2 bottom, 6 pipe		40CS602	1	473.75

Wavin Indoor Climate Solutions

MVHR Units

Description	Nom dia mm	Cat no	Pack qty	Price £ per piece
 Ventiza Ventiza HRU200 – Vertical 60l/s Unit Left Handed Right Handed	125 125	HRU220VL HRU220VR	1 1	1568.78 1568.78
 Ventiza HRU360 – Vertical 100l/s Unit Left Handed Right Handed	150 150	HRU360VL HRU360VR	1 1	1737.23 1737.23
 Ventiza HRU300 – Horizontal Ceiling Unit for 150mm diameter ducting for 204mm x 60mm ducting	150 204 x60	HRU300H1 HRU300H2	1 1	1879.45 1879.45
 Ventiza Ventilation Controller		VCONT001	1	190.09
 dMEV dMEV unit white plastic Standard Humidity sensor 100mm round telescopic wall kit Brown	100 100 100	dMEVCS001 dMEVCS002 100CS001	1 1 1	144.18 154.30 154.30
 Ventiza 75mm ducting system 75mm flexible ducting 50m	75	75CS700	1	123.96
 Plastic air distribution box 8 port	75/ 160	75CS701	1	82.36
 Plastic air distribution box 12 port	75/ 160	75CS702	1	82.36
 Plastic air distribution box 18 port	75/ 200	75CS703	1	137.46
 Plastic air distribution box 24 port	75/ 200	75CS704	1	137.46
 Plenum box 2 port		75CS705	1	14.88

Description	Nom dia mm	Cat no	Pack qty	Price £ per piece
Ventiza EPP ducting system				
 Length of 160mm duct 150cm	160	75CS128	1	61.22
 Elbow 45° 160mm	160	75CS129	1	30.61
 Tee 160mm	160	75CS130	1	36.73
 Connector sleeve 160mm	160	75CS131	1	11.02
 Length of 200mm duct 150cm	200	75CS132	1	67.34
 Elbow 45° 200mm	200	75CS133	1	33.67
 Tee 200mm	200	75CS134	1	42.86
 Connector sleeve 200mm	200	75CS135	1	11.10

Numerical index

Cat no	Price £ per piece	Page no	Cat no	Price £ per piece	Page no	Cat no	Price £ per piece	Page no
OT003B	25.21	5	OT033B	14.41	6	OT086N	63.99	6
OT003G	25.21	5	OT033G	14.41	6	OT086W	63.99	6
OT003N	25.21	5	OT033N	14.41	6	OT088AG	119.43	6
OT003W	25.21	5	OT033W	14.41	6	OT088B	119.43	6
OT004B	32.97	5	OT034AG	10.04	6	OT088G	119.43	6
OT004G	32.97	5	OT034B	10.04	6	OT088N	119.43	6
OT004N	32.97	5	OT034G	10.04	6	OT088W	119.43	6
OT004W	32.97	5	OT034N	10.04	6	OT092B	30.27	7
OT005B	13.18	4	OT034W	10.04	6	OT116B	3.25	8
OT005G	13.18	4	OT035AG	50.03	8	OT116G	3.25	8
OT005N	13.18	4	OT035B	50.03	8	OT116N	3.25	8
OT005W	13.18	4	OT035G	50.03	8	OT116W	3.25	8
OT007B	32.78	4	OT035N	50.03	8	OT143B	33.45	7
OT007G	32.78	4	OT035W	50.03	8	OT147G	38.18	21
OT007N	32.78	4	OT037AG	16.65	8	OT147G	38.18	19
OT007W	32.78	4	OT037B	16.65	8	OT147G	38.18	17
OT008B	29.55	5	OT037G	16.65	8	OT147G	38.18	15
OT009B	17.61	4	OT037N	16.65	8	OT147G	38.18	10
OT009G	17.61	4	OT037W	16.65	8	OT147G	38.18	6
OT009N	17.61	4	OT038AG	11.77	7	OT148G	35.26	6
OT009W	17.61	4	OT038B	11.77	7	OT148G	35.26	10
OT010B	8.44	4	OT038G	11.77	7	OT148G	35.26	15
OT010G	8.44	4	OT038N	11.77	7	OT148G	35.26	17
OT010N	8.44	4	OT038W	11.77	7	OT148G	35.26	19
OT010W	8.44	4	OT044B	7.14	20	OT148G	35.26	21
OT011B	10.87	5	OT044B	7.14	18	OT149B	32.03	11
OT011G	10.87	5	OT044B	7.14	16	OT149B	32.03	7
OT011N	10.87	5	OT044B	7.14	14	OT161AG	29.66	8
OT011W	10.87	5	OT044B	7.14	9	OT161B	29.66	8
OT014B	50.62	5	OT044B	7.14	4	OT161G	29.66	8
OT015B	50.62	5	OT045B	16.49	4	OT161N	29.66	8
OT016B	34.75	5	OT045B	16.49	9	OT161W	29.66	8
OT017B	77.52	5	OT045B	16.49	16	OT245B	32.54	6
OT019B	5.81	4	OT045B	16.49	18	OT246B	32.54	6
OT019G	5.81	4	OT060B	4.46	8	OT274AG	90.31	8
OT019N	5.81	4	OT061B	4.46	8	OT274B	90.31	8
OT019W	5.81	4	OT064G	4.46	8	OT274G	90.31	8
OT024AG	12.27	7	OT072B	40.80	4	OT274N	90.31	8
OT024B	12.27	7	OT072G	40.80	4	OT274W	90.31	8
OT024G	12.27	7	OT072N	40.80	4	OT332AG	67.18	8
OT024N	12.27	7	OT072W	40.80	4	OT332B	67.18	8
OT024W	12.27	7	OT074B	81.14	4	OT332G	67.18	8
OT025AG	15.38	7	OT074G	81.14	4	OT332N	67.18	8
OT025B	15.38	7	OT074N	81.14	4	OT332W	67.18	8
OT025G	15.38	7	OT074W	81.14	4	OT624B	26.64	4
OT025N	15.38	7	OT082B	45.75	6	OT624G	26.64	4
OT025W	15.38	7	OT082G	45.75	6	OT624N	26.64	4
OT026AG	19.12	7	OT082N	45.75	6	OT624W	26.64	4
OT026B	19.12	7	OT084AG	91.45	6	OT625B	40.61	4
OT026G	19.12	7	OT084B	91.45	6	OT745B	32.00	5
OT026N	19.12	7	OT084G	91.45	6	OT746B	34.63	5
OT026W	19.12	7	OT084N	91.45	6	OT914B	24.94	5
OT027B	23.86	8	OT084W	91.45	6	OT914G	24.94	5
OT030B	5.61	7	OT086AG	63.99	6	OT914N	24.94	5
OT031B	4.78	7	OT086B	63.99	6	OT914W	24.94	5
OT033AG	14.41	6	OT086G	63.99	6	OT985B	17.74	20

Cat no	Price £ per piece	Page no	Cat no	Price £ per piece	Page no	Cat no	Price £ per piece	Page no
OT985B	17.74	18	2CS805SE	14.17	66	2S398W	14.83	27
OT985B	17.74	17	2CS812SE	16.54	66	2S399B	14.83	28
OT985B	17.74	15	2CS813SE	23.53	66	2S399E	14.83	62
OT985B	17.74	10	2CS814SE	13.79	66	2S399G	14.83	28
OT985B	17.74	5	2CS815SE	12.73	66	2S399W	14.83	28
OT986B	26.65	5	2CS816SE	15.19	66	2S402B	19.12	28
OT986B	26.65	10	2M073B	77.01	67	2S402E	19.12	62
OT986B	26.65	15	2M073E	77.01	67	2S402G	19.12	28
OT986B	26.65	17	2M073W	77.01	67	2S402W	19.12	28
OT986B	26.65	18	2M081E	3.98	67	2S403B	15.19	34
OT986B	26.65	20	2M104E	15.56	67	2S403E	15.19	62
OT988B	14.80	5	2M104W	15.56	67	2S403G	15.19	34
OT988B	14.80	10	2M124E	30.00	67	2S403W	15.19	34
OT988B	14.80	15	2M124W	30.00	67	2S498B	16.45	49
OT988B	14.80	17	2M160B	23.89	67	2S499B	16.45	49
OT988B	14.80	18	2M160E	23.89	67	2S503B	17.17	49
OT988B	14.80	20	2M160W	23.89	67	2V414G	226.01	49
OT989B	19.86	5	2M161B	23.34	68	2V418G	36.80	49
OT989B	19.86	10	2M161E	23.34	68	2V502G	197.87	49
OT989B	19.86	15	2M161W	23.34	68	2W073G	38.26	44
OT989B	19.86	17	2M163B	20.06	68	2W073W	38.26	44
OT989B	19.86	18	2M163E	20.06	68	2W081G	2.85	44
OT989B	19.86	20	2M163W	20.06	68	2W081W	2.85	44
OT999	137.51	5	2M190B	32.27	68	2W086G	10.00	46
1C074W	17.23	51	2M190E	32.27	68	2W086W	10.00	46
1C104W	5.73	51	2M190W	32.27	68	2W088G	8.94	46
1C139W	10.43	51	2M260B	26.34	68	2W088W	8.94	46
1C160W	5.57	51	2M260E	26.34	68	2W102G	10.41	45
1C163W	6.81	51	2M260W	26.34	68	2W102G	10.41	42
1C190W	7.99	51	2M292B	19.19	68	2W102G*	10.41	74
1C344W	8.59	51	2M292E	19.19	68	2W105G	10.24	44
1C344W	8.59	46	2M292W	19.19	68	2W105W	10.24	44
1C346W	8.59	46	2M456B	13.35	69	2W160G	10.24	44
1C346W	8.59	51	2M456E	13.35	69	2W160W	10.24	44
1E073W	14.54	51	2M456W	13.35	69	2W163G	10.82	44
1E082W	2.08	51	2M458B	13.35	69	2W163W	10.82	44
1E104W	5.96	51	2M458E	13.35	69	2W190G	10.00	45
1E129W	9.28	51	2M458W	13.35	69	2W190W	10.00	45
1E139W	10.36	51	2S298B	13.79	34	2W260W	10.00	45
1E156W	8.63	52	2S298E	13.79	62	2W292G	10.24	45
1E160W	6.17	51	2S298G	13.79	34	2W292W	10.24	45
1E163W	7.07	51	2S298W	13.79	34	2Z073B	45.87	40
1E166W	7.07	51	2S299B	12.73	34	2Z073W	45.87	40
1E190W	7.62	51	2S299E	12.73	62	2Z074G	61.15	40
1E344B	8.59	43	2S299G	12.73	34	2Z081B	3.98	67
1E344B	8.59	51	2S299W	12.73	34	2Z081B	3.98	40
1E344W	8.59	43	2S355W	17.25	63	2Z081G	3.98	40
1E344W	8.59	51	2S355W	17.25	26	2Z081G	3.98	67
1E346B	8.59	43	2S355W*	17.25	58	2Z081W	3.98	40
1E346B	8.59	51	2S356W	28.39	26	2Z081W	3.98	67
1E346W	8.59	43	2S356W	28.39	63	2Z086B	9.39	43
1E346W	8.59	51	2S356W*	28.39	58	2Z086G	9.39	43
1O158W	5.73	52	2S360G	21.04	28	2Z086W	9.39	43
1O159W	6.81	52	2S398B	14.83	27	2Z088B	9.61	43
2CS802SE	23.53	66	2S398E	14.83	62	2Z088G	9.61	43
2CS804SE	14.17	66	2S398G	14.83	27	2Z088W	9.61	43

Numerical index

Cat no	Price £ per piece	Page no	Cat no	Price £ per piece	Page no	Cat no	Price £ per piece	Page no
2Z104B	11.19	40	3S288B	84.39	38	4S044E	193.46	60
2Z104G	11.19	40	3S292B	62.73	35	4S044G	188.80	22
2Z104W	11.19	40	3S292B	62.73	30	4S044W	188.80	22
2Z124W	19.44	40	3S292G	62.73	30	4S050G	126.21	22
2Z124W*	19.44	74	3S292G	62.73	35	4S073B	134.63	31
2Z128W	19.91	43	3S300B	26.05	38	4S073B	134.63	22
2Z160B	13.45	40	3S300G	27.57	38	4S073E	134.63	60
2Z160G	13.45	40	3S302B	22.83	38	4S073G	134.63	22
2Z160W	13.45	40	3S302G	22.83	38	4S073G	134.63	31
2Z161B	14.25	41	3S319B	30.02	29	4S073W	134.63	22
2Z161G	14.25	41	3S319G	30.02	29	4S073W	134.63	31
2Z161W	14.25	41	3S414G	220.91	38	4S074B	179.48	22
2Z163B	14.59	41	3S435G	67.19	25	4S074B	179.48	31
2Z163G	14.59	41	3S440B	79.28	26	4S074E	179.48	60
2Z163W	14.59	41	3S440G	79.28	26	4S074G	179.48	22
2Z190B	19.64	41	3S530B	176.67	38	4S074G	179.48	31
2Z190G	19.64	41	3S649B	61.55	28	4S074W	179.48	22
2Z190W	19.64	41	3S649G	61.55	28	4S074W	179.48	31
2Z210B	25.44	42	4A830W	9.48	49	4S082B	12.39	31
2Z210G	25.44	42	4CS588SE	26.99	66	4S082B	12.39	22
2Z210W	25.44	42	4CS832SE	261.28	66	4S082E	12.39	60
2Z230W	46.51	42	4CS834SE	261.28	66	4S082G	12.39	22
2Z260B	12.20	41	4CS895SE	108.64	66	4S082G	12.39	31
2Z260G	12.20	41	4M073B	45.88	67	4S082W	12.39	22
2Z260W	12.20	41	4M073E	45.88	67	4S082W	12.39	31
2Z292B	14.42	42	4M073W	45.88	67	4S083B	16.51	31
2Z292G	14.42	42	4M081E	1.92	67	4S083B	16.51	22
2Z292W	14.42	42	4M104B	7.61	67	4S083E	16.51	60
2Z347G	12.51	43	4M104E	7.61	67	4S083G	16.51	22
2Z349G	11.85	43	4M104W	7.61	67	4S083G	16.51	31
2Z359G	22.73	41	4M124E	16.07	67	4S083W	16.51	22
2Z359G*	22.73	74	4M124W	16.07	67	4S083W	16.51	31
3S043B	161.22	22	4M160B	11.37	67	4S084	35.78	22
3S043G	161.22	22	4M160E	11.37	67	4S084	35.78	31
3S074G	210.28	22	4M160W	11.37	67	4S085	239.24	31
3S082B	14.49	22	4M161B	13.91	68	4S085	239.24	23
3S082G	14.49	22	4M161E	13.91	68	4S086	116.24	31
3S083B	19.27	22	4M161W	13.91	68	4S086	116.24	23
3S083G	19.27	22	4M163B	10.56	68	4S095B	57.43	32
3S094B	66.55	24	4M163E	10.56	68	4S095B	57.43	24
3S094G	66.55	24	4M163W	10.56	68	4S095E	57.43	60
3S105B	54.47	23	4M190B	18.17	68	4S095G	57.43	24
3S105G	54.47	23	4M190E	18.17	68	4S095G	57.43	32
3S116B	3.77	30	4M190W	18.17	68	4S096B	62.61	24
3S116G	3.77	30	4M260E	14.67	68	4S096E	62.61	60
3S124B	31.76	23	4M260W	14.67	68	4S096G	62.61	24
3S124G	31.76	23	4M292B	11.25	68	4S097G	65.96	24
3S161B	64.48	24	4M292E	11.25	68	4S098G	65.96	24
3S161G	64.48	24	4M292W	11.25	68	4S104B	27.23	23
3S163B	64.48	25	4S042B	106.45	22	4S104B	27.23	31
3S163G	64.48	25	4S042G	106.45	22	4S104E	27.23	60
3S190B	114.78	26	4S043B	139.94	22	4S104G	27.23	23
3S190G	114.78	26	4S043E	139.94	60	4S104G	27.23	31
3S210G	114.78	27	4S043G	139.94	22	4S104W	27.23	23
3S274B	126.72	29	4S043W	139.94	22	4S104W	27.23	31
3S274G	126.72	29	4S044B	188.80	22	4S105B	58.81	31

Cat no	Price £ per piece	Page no	Cat no	Price £ per piece	Page no	Cat no	Price £ per piece	Page no
4S105B	58.81	23	4S195W	137.39	26	4S300B	24.30	38
4S105E	58.81	60	4S200B	153.74	27	4S300E	25.71	65
4S105G	58.81	23	4S200G	153.74	27	4S300G	24.30	38
4S105G	58.81	31	4S205B	50.68	23	4S300W	24.30	38
4S105W	58.81	23	4S205G	50.68	23	4S302B	17.38	38
4S105W	58.81	31	4S205W	50.68	23	4S302E	17.38	64
4S106G	80.15	23	4S206B	87.10	24	4S302G	17.38	38
4S107E	49.33	60	4S206B	87.10	32	4S302W	17.38	38
4S116B	12.17	30	4S210B	157.56	27	4S303W	131.55	43
4S116G	12.17	30	4S210G	157.56	27	4S303W	131.55	38
4S116W	12.17	30	4S220B	153.74	27	4S303W	131.55	46
4S120W	32.43	36	4S220G	153.74	27	4S304W	297.30	38
4S121W	34.59	36	4S230B	265.05	27	4S306G	193.06	38
4S124B	28.36	32	4S230G	265.05	27	4S308B	212.25	38
4S124B	28.36	23	4S230W	265.05	27	4S310B	87.79	38
4S124E	28.36	60	4S250G	330.42	27	4S310E	87.79	65
4S124G	28.36	23	4S260B	84.84	33	4S310G	87.79	38
4S124G	28.36	32	4S260E	84.84	61	4S310W	87.79	38
4S124W	28.36	23	4S260G	84.84	33	4S319B	25.18	35
4S124W	28.36	32	4S263B	79.88	32	4S319B	25.18	29
4S125B	43.08	32	4S263E	79.88	61	4S319E	25.18	64
4S125B	43.08	23	4S263G	79.88	32	4S319G	25.18	29
4S125E	43.08	60	4S268B	77.07	33	4S319G	25.18	35
4S125G	43.08	23	4S268E	77.07	61	4S319W	25.18	29
4S125G	43.08	32	4S268G	77.07	33	4S319W	25.18	35
4S130G	8.77	30	4S274B	127.14	30	4S321B	30.98	29
4S149	25.49	11	4S274G	127.14	30	4S321G	30.98	29
4S149	25.49	7	4S274W	127.14	30	4S321W	30.98	29
4S159	27.17	7	4S275B	69.17	35	4S322B	30.98	29
4S159	27.17	12	4S275B	69.17	30	4S322G	30.98	29
4S160B	83.41	24	4S275G	69.17	30	4S322W	30.98	29
4S160G	83.41	24	4S275G	69.17	35	4S326B	148.64	19
4S160W	83.41	24	4S281G	236.45	38	4S326B	148.64	21
4S161B	75.09	24	4S283G	227.75	38	4S326B	148.64	38
4S161E	75.09	61	4S288B	125.95	38	4S326G	148.64	21
4S161G	75.09	24	4S288G	125.95	38	4S326G	148.64	38
4S161W	75.09	24	4S290B	104.44	33	4S361G	73.92	24
4S162G	107.78	25	4S290E	104.44	62	4S363B	73.92	25
4S163B	75.09	25	4S290G	104.44	33	4S363G	73.92	25
4S163G	75.09	25	4S291G	417.24	27	4S363W	73.92	25
4S163W	75.09	25	4S292B	58.71	30	4S369G	202.99	29
4S164B	106.94	25	4S292B	58.71	35	4S374G	129.08	30
4S164G	106.94	25	4S292E	58.71	64	4S380G	31.24	39
4S166G	83.15	25	4S292G	58.71	30	4S383G	36.20	39
4S167G	95.69	25	4S292G	58.71	35	4S384G	48.73	39
4S169B	176.66	29	4S292W	58.71	30	4S385G	106.07	39
4S169G	176.66	29	4S292W	58.71	35	4S391G	40.66	39
4S169W	176.66	29	4S296B	41.38	35	4S392	70.80	39
4S173E	94.34	61	4S296B	41.38	30	4S394G	51.34	39
4S173G	94.34	25	4S296E	41.38	64	4S395G	119.15	27
4S179G	106.67	25	4S296G	41.38	30	4S410B	117.99	33
4S190B	105.99	26	4S296G	41.38	35	4S410E	117.99	62
4S190G	105.99	26	4S296W	41.38	30	4S410G	117.99	33
4S190W	105.99	26	4S296W	41.38	35	4S414G	245.08	38
4S195B	137.39	26	4S298	28.79	24	4S416B	13.49	32
4S195G	137.39	26	4S299	33.14	24	4S416E	13.49	61

Numerical index

Cat no	Price £ per piece	Page no	Cat no	Price £ per piece	Page no	Cat no	Price £ per piece	Page no
4S416G	13.49	32	4S495B	108.64	33	4S612W	374.16	36
4S430B	261.28	33	4S495E	108.64	63	4S613W	374.16	36
4S430E	261.28	62	4S495G	108.64	33	4S614W	374.16	36
4S430G	261.28	33	4S496B	56.49	32	4S615W	374.16	36
4S435B	70.08	25	4S496E	56.49	60	4S616W	374.16	36
4S435B	70.08	33	4S496G	56.49	32	4S711W	67.41	36
4S435E	70.08	61	4S502B	239.24	29	4S771W	96.45	36
4S435G	70.08	25	4S502G	239.24	29	4S772W	83.70	36
4S435G	70.08	33	4S561B	93.66	25	4S790W	96.13	37
4S435W	70.08	25	4S561G	93.66	25	4S791W	56.85	36
4S435W	70.08	33	4S561W	93.66	25	4T731B	13.78	11
4S440B	96.13	26	4S574B	123.74	35	4T731W	13.78	11
4S440E	96.13	61	4S574E	123.74	64	4T803B	27.54	9
4S440G	96.13	26	4S574G	123.74	35	4T803N	27.54	9
4S440W	96.13	26	4S581B	80.55	28	4T803W	27.54	9
4S444B	96.13	26	4S581G	80.55	28	4T804B	38.24	10
4S444G	96.13	26	4S582B	64.52	28	4T804N	38.24	10
4S444W	96.13	26	4S582G	64.52	28	4T804W	38.24	10
4S445B	106.94	26	4S583B	31.30	28	4T805B	17.09	9
4S445G	106.94	26	4S583G	31.30	28	4T805N	17.09	9
4S445W	106.94	26	4S583W	31.30	28	4T805W	17.09	9
4S450B	78.20	33	4S584B	27.20	28	4T806B	28.40	9
4S450E	78.20	61	4S584G	27.20	28	4T806N	28.40	9
4S450G	78.20	33	4S584W	27.20	28	4T806W	28.40	9
4S461B	73.83	32	4S585B	36.10	34	4T807B	30.11	9
4S461E	73.83	61	4S585E	36.10	64	4T807N	30.11	9
4S461G	73.83	32	4S585G	36.10	34	4T807W	30.11	9
4S461W	73.83	32	4S586B	36.10	34	4T809B	27.27	9
4S462B	79.88	32	4S586E	36.10	63	4T809N	27.27	9
4S462G	79.88	32	4S586G	36.10	34	4T809W	27.27	9
4S463B	73.75	32	4S588B	26.99	28	4T810B	10.90	9
4S463E	73.75	61	4S588B	26.99	34	4T810N	10.90	9
4S463G	73.75	32	4S588E	26.99	63	4T810W	10.90	9
4S469B	186.10	35	4S588G	26.99	28	4T811B	12.58	9
4S469E	186.10	64	4S588G	26.99	34	4T811N	12.58	9
4S469G	186.10	35	4S588W	26.99	28	4T811W	12.58	9
4S474B	123.74	35	4S588W	26.99	34	4T816B	4.00	13
4S474E	123.74	64	4S589B	43.89	28	4T816N	4.00	13
4S474G	123.74	35	4S589G	43.89	28	4T816W	4.00	13
4S483B	32.43	34	4S589W	43.89	28	4T818B	46.21	10
4S483E	32.43	64	4S590B	52.30	29	4T818W	46.21	10
4S483G	32.43	34	4S590B	52.30	35	4T819B	7.36	9
4S484B	32.43	34	4S590G	52.30	29	4T819N	7.36	9
4S484E	32.43	64	4S590G	52.30	35	4T819W	7.36	9
4S484G	32.43	34	4S595E	129.83	63	4T823B	25.91	11
4S490B	104.38	33	4S595G	129.83	26	4T823N	25.91	11
4S490E	104.38	63	4S597E	118.08	63	4T823W	25.91	11
4S490G	104.38	33	4S597G	118.08	26	4T824B	28.62	11
4S491B	462.41	34	4S597G	118.08	33	4T824N	28.62	11
4S491E	462.41	62	4S600W	60.42	37	4T824W	28.62	11
4S491G	462.41	34	4S601W	374.16	36	4T825B	16.41	12
4S492B	73.95	35	4S602W	374.16	36	4T825N	16.41	12
4S492E	73.95	64	4S603W	374.16	36	4T825W	16.41	12
4S492G	73.95	35	4S604W	374.16	36	4T826B	20.36	12
4S493B	198.09	35	4S605W	374.16	36	4T826N	20.36	12
4S493E	198.09	62	4S606W	374.16	36	4T826W	20.36	12

Cat no	Price £ per piece	Page no	Cat no	Price £ per piece	Page no	Cat no	Price £ per piece	Page no
4T830B	84.86	12	4V809W	31.44	47	4Z124W	11.77	40
4T830N	84.86	12	4V811W	26.70	48	4Z124W	11.77	63
4T830W	84.86	12	4V812W	39.16	47	4Z124W*	11.77	58
4T832B	24.31	12	4V814W	52.19	47	4Z127W	15.97	42
4T832N	24.31	12	4V816W	52.19	47	4Z128W	15.11	43
4T832W	24.31	12	4V825W	49.94	48	4Z160B	7.26	40
4T833B	9.74	11	4W073B	19.66	44	4Z160G	7.26	40
4T833N	9.74	11	4W073G	19.66	44	4Z160W	7.26	40
4T833W	9.74	11	4W073W	19.66	44	4Z161B	7.63	41
4T834B	8.29	11	4W081B	1.73	44	4Z161G	7.63	41
4T834N	8.29	11	4W081G	1.73	44	4Z161W	7.63	41
4T834W	8.29	11	4W081W	1.73	44	4Z163B	6.83	41
4T835B	67.27	12	4W102B	10.82	42	4Z163G	6.83	41
4T835N	67.27	12	4W102B	10.82	45	4Z163W	6.83	41
4T835W	67.27	12	4W102G	10.82	42	4Z185W	19.03	42
4T836B	23.48	11	4W102G	10.82	45	4Z190B	9.05	41
4T836W	23.48	11	4W102W	10.82	42	4Z190G	9.05	41
4T837B	29.29	11	4W102W	10.82	45	4Z190W	9.05	41
4T837W	29.29	11	4W105B	5.66	44	4Z210W	14.33	42
4T838B	32.93	12	4W105G	5.66	44	4Z260B	9.90	41
4T838N	32.93	12	4W105W	5.66	44	4Z260G	9.90	41
4T838W	32.93	12	4W160B	5.24	44	4Z260W	9.90	41
4T855B	92.35	12	4W160G	5.24	44	4Z263B	5.81	41
4T858B	92.35	12	4W160W	5.24	44	4Z263W	5.81	41
4T860G	4.48	13	4W161B	5.66	44	4Z292B	7.75	42
4T861G	4.38	13	4W161G	5.66	44	4Z292G	7.75	42
4T862B	35.02	12	4W161W	5.66	44	4Z292W	7.75	42
4T862N	35.02	12	4W163B	5.66	44	4Z343G	6.55	50
4T862W	35.02	12	4W163G	5.66	44	4Z343G	6.55	43
4T864B	4.29	12	4W163W	5.66	44	4Z363W	11.73	42
4T872B	43.28	9	4W166B	5.24	45	4Z364W	7.62	42
4T872N	43.28	9	4W166W	5.24	45	5A830W	10.17	49
4T872W	43.28	9	4W190B	6.04	45	5M073B	50.05	67
4T874B	86.60	9	4W190G	6.04	45	5M073E	50.05	67
4T874N	86.60	9	4W190W	6.04	45	5M073W	50.05	67
4T874W	86.60	9	4W260B	6.04	45	5M081E	1.95	67
4T882B	46.14	11	4W260G	6.04	45	5M104B	9.59	67
4T882N	46.14	11	4W260W	6.04	45	5M104E	9.59	67
4T882W	46.14	11	4W292B	5.66	45	5M104W	9.59	67
4T884B	94.51	11	4W292G	5.66	45	5M124E	16.79	67
4T884N	94.51	11	4W292W	5.66	45	5M124W	16.79	67
4T884W	94.51	11	4Z073B	28.95	40	5M160B	13.38	67
4T886B	65.20	11	4Z073W	28.95	40	5M160E	13.38	67
4T886N	65.20	11	4Z074G	38.59	40	5M160W	13.38	67
4T886W	65.20	11	4Z081B	1.93	40	5M161B	16.79	68
4T888B	130.02	11	4Z081B	1.93	67	5M161E	16.79	68
4T888N	130.02	11	4Z081G	1.93	40	5M161W	16.79	68
4T888W	130.02	11	4Z081G	1.93	67	5M163B	11.86	68
4T894B	30.67	10	4Z081W	1.93	40	5M163E	11.86	68
4T999	143.47	10	4Z081W	1.93	67	5M163W	11.86	68
4V801W	29.98	47	4Z104B	5.45	40	5M190B	20.71	68
4V803W	36.68	47	4Z104G	5.45	40	5M190E	20.71	68
4V804W	56.26	47	4Z104W	5.45	40	5M190W	20.71	68
4V806W	32.58	48	4Z120W	7.94	42	5M260E	17.72	68
4V807W	44.50	47	4Z124G	11.77	40	5M260W	17.72	68
4V808W	56.55	47	4Z124W	11.77	26	5M292B	11.05	68

Numerical index

Cat no	Price £ per piece	Page no	Cat no	Price £ per piece	Page no	Cat no	Price £ per piece	Page no
5M292E	11.05	68	5W102G*	10.82	74	5Z163G	7.63	41
5M292W	11.05	68	5W102W	10.82	42	5Z163W	7.63	41
5M455B	7.07	69	5W102W	10.82	45	5Z185W	19.72	42
5M455E	7.07	69	5W105B	6.04	44	5Z190B	9.54	41
5M455W	7.07	69	5W105G	6.04	44	5Z190G	9.54	41
5T503B	41.70	18	5W105W	6.04	44	5Z190W	9.54	41
5T504B	47.52	18	5W160B	5.25	44	5Z210B	17.43	42
5T508B	37.26	18	5W160G	5.25	44	5Z210G	17.43	42
5T509B	24.95	18	5W160W	5.25	44	5Z210W	17.43	42
5T510B	12.12	18	5W161B	5.66	44	5Z230W	30.72	42
5T511B	18.27	18	5W161G	5.66	44	5Z260B	9.61	41
5T516B	4.28	19	5W161W	5.66	44	5Z260G	9.61	41
5T519B	9.11	18	5W163B	5.24	44	5Z260W	9.61	41
5T564B	4.85	19	5W163G	5.24	44	5Z263B	6.75	41
5T574B	125.11	18	5W163W	5.24	44	5Z263G	6.75	41
5T594B	40.12	18	5W166B	5.24	45	5Z263W	6.75	41
5T595B	43.28	19	5W166G	5.24	45	5Z292B	8.15	42
5T596B	45.79	19	5W166W	5.24	45	5Z292G	8.15	42
5V407W	78.41	49	5W185B	6.73	45	5Z292W	8.15	42
5V407W	78.41	50	5W190B	5.25	45	5Z344G	6.75	43
5V468W	89.94	50	5W190G	5.25	45	5Z363W	11.73	42
5V801W	34.10	47	5W190W	5.25	45	5Z364W	8.59	42
5V802W	39.88	48	5W260B	6.04	45	5Z455B	5.13	43
5V803W	54.95	47	5W260G	6.04	45	5Z455G	5.13	43
5V805W	60.17	47	5W260W	6.04	45	5Z455W	5.13	43
5V806W	27.04	48	5W292B	5.24	45	6S043E	534.10	60
5V807W	51.82	47	5W292G	5.24	45	6S043G	521.22	22
5V808W	67.82	47	5W292W	5.24	45	6S044G	678.20	22
5V809W	41.76	47	5Z073B	35.76	40	6S074B	627.91	22
5V811W	28.99	48	5Z073W	35.76	40	6S074B	627.91	31
5V812W	47.91	47	5Z074G	47.60	40	6S074E	627.91	60
5V814W	65.88	47	5Z081B	1.94	40	6S074G	627.91	22
5V816W	65.89	47	5Z081B	1.94	67	6S074G	627.91	31
5V823W	65.71	48	5Z081G	1.94	40	6S082B	45.43	22
5V842W	55.53	48	5Z081G	1.94	67	6S082B	45.43	31
5V846W	50.60	48	5Z081W	1.94	40	6S082E	45.43	60
5V848W	127.24	48	5Z081W	1.94	67	6S082G	45.43	22
5V860W	111.76	48	5Z085B	6.83	43	6S082G	45.43	31
5V864W	60.41	49	5Z085G	6.83	43	6S084	75.47	22
5V869W	88.67	49	5Z085W	6.83	43	6S084	75.47	31
5V870W	51.65	49	5Z104B	5.60	40	6S099G	147.02	24
5V871W	24.44	49	5Z104G	5.60	40	6S104B	65.99	23
5V901W	38.71	47	5Z104W	5.60	40	6S104B	65.99	31
5W073B	22.76	44	5Z120W	7.94	42	6S104E	65.99	60
5W073G	22.76	44	5Z124G	11.19	40	6S104G	65.99	23
5W073W	22.76	44	5Z124W	11.19	59	6S104G	65.99	31
5W081B	1.64	44	5Z124W	11.19	40	6S105E	165.69	60
5W081G	1.64	44	5Z127W	17.37	42	6S105G	165.69	23
5W081W	1.64	44	5Z128W	15.97	43	6S105G	165.69	31
5W084B	5.24	46	5Z160B	8.59	40	6S124B	97.06	23
5W084G	5.24	46	5Z160G	8.59	40	6S124B	97.06	32
5W084W	5.24	46	5Z160W	8.59	40	6S124E	97.06	60
5W102B	10.82	42	5Z161B	9.12	41	6S124G	97.06	23
5W102B	10.82	45	5Z161G	9.12	41	6S124G	97.06	32
5W102G	10.82	42	5Z161W	9.12	41	6S130G	15.56	30
5W102G	10.82	45	5Z163B	7.63	41	6S161G	254.28	24

Cat no	Price £ per piece	Page no	Cat no	Price £ per piece	Page no	Cat no	Price £ per piece	Page no
6S163G	254.28	25	8T806W	33.55	14	9T910G	9.05	16
6S190G	459.25	26	8T807B	31.09	14	9T910N	9.05	16
6S198G	353.94	27	8T807W	31.09	14	9T910W	9.05	16
6S210G	459.25	27	8T808B	31.09	14	9T911AG	12.75	16
6S218G	353.94	27	8T808W	31.09	14	9T911B	12.75	16
6S238G	625.48	27	8T809B	25.14	14	9T911G	12.75	16
6S274G	344.40	30	8T809W	25.14	14	9T911N	12.75	16
6S292B	128.38	30	8T816B	3.77	15	9T911W	12.75	16
6S292B	128.38	35	8T816W	3.77	15	9T916AG	3.49	17
6S292G	128.38	30	8T819B	9.33	14	9T916B	3.49	17
6S292G	128.38	35	8T819W	9.33	14	9T916G	3.49	17
6S302G	65.20	38	8T840B	14.13	14	9T916N	3.49	17
6S323G	61.01	29	8T840W	14.13	14	9T916W	3.49	17
6S416E	33.81	61	8T841B	19.77	14	9T919AG	7.23	16
6S440G	284.16	26	8T841W	19.77	14	9T919B	7.23	16
6S461B	194.51	32	8T843B	36.99	14	9T919G	7.23	16
6S461E	194.51	61	8T843W	36.99	14	9T919N	7.23	16
6S461G	194.51	32	8T844B	38.91	15	9T919W	7.23	16
6S463B	199.22	32	8T844W	38.91	15	9T964B	3.42	17
6S463E	199.22	61	8T849B	12.41	14	9T974AG	94.91	16
6S463G	199.22	32	8T849W	12.41	14	9T974B	94.91	16
6S474B	280.54	35	8T850B	14.13	14	9T974G	94.91	16
6S474E ^A	280.54	64	8T850W	14.13	14	9T974N	94.91	16
6S474G	280.54	35	8T851B	19.77	14	9T974W	94.91	16
6S490B	332.11	33	8T851W	19.77	14	9T994AG	33.58	17
6S490E	332.11	63	8T853B	32.92	14	9T994B	33.58	17
6S490G	332.11	33	8T853W	32.92	14	9T994G	33.58	17
6S498B	256.21	33	8T854B	38.91	15	9T999	145.26	17
6S498E	256.21	63	8T854W	38.91	15	12CS050	74.86	109
6S498G	256.21	33	8T864B	3.58	15	12CS080	117.98	109
6S499B	106.50	32	8T874B	117.50	14	12CS100	147.48	109
6S499E	106.50	60	8T874W	117.50	14	12CS300	1.34	110
6S499G	106.50	32	8T894B	36.87	15	12CS303	9.20	110
6T603B	129.34	20	8T999	159.21	15	12CS310	22.09	113
6T603G	129.34	20	9T903AG	32.97	17	12CS319	262.80	113
6T606B	92.09	20	9T903B	32.97	17	12CS501	5.13	111
6T606G	92.09	20	9T903G	32.97	17	12CS910	36.46	109
6T609B	67.06	20	9T903N	32.97	17	12CS920	70.34	109
6T609G	67.06	20	9T903W	32.97	17	12CS960	208.41	109
6T610B	15.78	20	9T904AG	37.78	17	16CS050	87.85	109
6T610G	15.78	20	9T904B	37.78	17	16CS080	144.44	109
6T611B	45.69	20	9T904G	37.78	17	16CS100	179.47	109
6T611G	45.69	20	9T904N	37.78	17	16CS120	208.83	109
6T616B	4.79	21	9T904W	37.78	17	16CS150	258.97	109
6T616G	4.79	21	9T906AG	25.48	16	16CS200	358.94	109
6T619B	23.48	20	9T906B	25.48	16	16CS300	1.34	110
6T619G	23.48	20	9T906G	25.48	16	16CS303	11.71	110
6T664B	5.22	21	9T906N	25.48	16	16CS307	12.95	113
6T674B	252.29	20	9T906W	25.48	16	16CS500	853.51	109
6T674G	252.29	20	9T909AG	20.74	16	16CS501	5.83	111
6T694B	50.86	20	9T909B	20.74	16	16CS505	3.71	111
6T694G	50.86	20	9T909G	20.74	16	16CS506	5.53	111
6T695B	47.48	20	9T909N	20.74	16	16CS913	67.89	109
6T696B	50.23	20	9T909W	20.74	16	16CS925	144.29	109
6T999	231.81	20	9T910AG	9.05	16	16CS948	264.73	109
8T806B	33.55	14	9T910B	9.05	16	16CS960	332.08	109

Numerical index

Cat no	Price £ per piece	Page no	Cat no	Price £ per piece	Page no	Cat no	Price £ per piece	Page no
20CS100	219.32	109	35CS402	123.10	114	3003493	7.94	77
20CS120	280.49	109	35CS403	96.87	114	3003494 ^A	7.94	77
20CS140	327.24	109	35CS404	74.02	114	3003495	11.29	77
20CS160	373.95	109	35CS405	222.02	114	3003496 ^A	11.29	77
20CS180	420.70	109	35CS406	84.10	114	3003497	14.33	77
20CS200	467.46	109	35CS407	136.62	114	3003498 ^A	22.82	77
20CS300	2.67	110	35CS408	6.92	114	3003499	45.01	77
20CS307	12.95	113	35CS411	95.00	114	3003505	15.72	77
20CS501	6.53	111	35CS489	11.18	114	3003506	15.53	77
25CS348	58.58	113	35CS490	11.18	114	3003507	18.57	77
25CS349	66.98	113	35CS498	21.63	115	3003508	19.73	77
25CS350	24.59	113	35CS499	21.63	115	3003509	20.24	77
30CS301	0.07	110	35CS500	56.53	115	3003510	20.75	77
30CS302	3.05	110	35CS501	25.18	115	3003511 ^A	31.54	77
30CS304	26.34	110	35CS503	42.40	115	3003512	57.26	77
30CS305	320.47	110	35CS504	59.36	115	3003513*	265.40	77
30CS306	0.38	110	35CS505	7.07	115	3003515	672.58	77
30CS502	153.12	111	35CS508	39.57	115	3003516 ^A	43.06	78
30CS503	174.14	111	35CS509	42.40	115	3003528 ^A	51.61	78
30CS504	203.53	111	35CS510	49.47	115	3003550 ^A	32.64	76
30CS505	231.63	111	35CS511	60.77	115	3003554 ^A	31.83	76
30CS506	255.58	111	40CS601	151.95	117	3003569	5.38	71
30CS507	284.10	111	40CS602	473.75	117	3003570 ⁱ	5.93	72
30CS508	313.12	111	40CS605	1681.36	117	3003572	6.81	71
30CS509	340.56	111	40CS606	1708.34	117	3003573 ⁱ	8.41	72
30CS510	369.52	111	40CS607	1786.47	117	3003574	9.89	71
30CS511	398.49	111	40CS608	1714.43	117	3003575	11.99	72
30CS512	419.97	111	40CS609	1741.41	117	3003576	33.04	71
30CS513	36.20	111	40CS610	1819.54	117	3003577	9.68	71
30CS515	266.44	111	75CS128	61.22	119	3003579 ⁱ	12.97	72
30CS516	23.42	111	75CS129	30.61	119	3003582	15.87	71
30CS521	18.02	111	75CS130	36.73	119	3003583 ⁱ	20.83	72
30CS530	37.37	112	75CS131	11.02	119	3003584	50.51	71
30CS532	117.23	112	75CS132	67.34	119	3003585	41.24	71
30CS533	139.15	112	75CS133	33.67	119	3003587 ⁱ	53.43	72
30CS534	162.68	112	75CS134	42.86	119	3003597	4.23	71
30CS535	190.86	112	75CS135	11.10	119	3003598	4.74	72
30CS536	209.71	112	75CS700	123.96	118	3003601 ^A	7.41	72
30CS537	232.13	112	75CS701	82.36	118	3003602	11.99	72
30CS538	270.73	112	75CS702	82.36	118	3003603	11.91	72
30CS539	298.13	112	75CS703	137.46	118	3003605 ^A	21.90	72
30CS540	325.06	112	75CS704	137.46	118	3003619 ^A	61.28	76
30CS541	358.32	112	75CS705	14.88	118	3003620 ^A	60.88	76
30CS542	377.73	112	100CS001	154.30	118	3003621 ^A	123.01	76
30CS543	4.36	112	3003458	71.97	70	3003622	8.98	72
30CS545	26.71	112	3003459	90.21	70	3003633	9.36	73
30CS547	1.01	112	3003460	129.78	70	3003634 ^A	11.03	73
30CS548	55.86	116	3003461	202.80	70	3003635Q ^A	9.09	72
30CS549	60.62	116	3003462	270.46	70	3003637Q	9.60	73
30CS550	67.07	116	3003463	430.82	70	3003638	9.29	73
30CS551	61.85	116	3003464	669.66	70	3003639Q	6.14	73
30CS552	65.95	116	3003465	25.63	70	3003641	10.41	73
30CS553	70.57	116	3003466	30.36	70	3003642	11.03	74
30CS554	39.92	111	3003467	41.77	70	3003643Q	12.06	73
35CS400	93.94	114	3003468	48.30	70	3003645Q	11.45	73
35CS401	63.91	114	3003477	35.75	70	3003646 ^A	10.98	73

Cat no	Price £ per piece	Page no	Cat no	Price £ per piece	Page no	Cat no	Price £ per piece	Page no
3003647Q	7.99	73	3003726	8.98	73	3003842Q	5.36	70
3003648 ^Δ	13.99	74	3003727	8.94	73	3003843	6.16	70
3003649	10.46	73	3003728	32.75	72	3003856*	323.72	71
3003650	10.98	73	3003730 ^Δ	29.38	72	3003858	7.88	70
3003651Q ^Δ	21.09	73	3003732 ^Δ	27.83	76	3003860	4.43	78
3003652	13.96	74	3003734 ^Δ	35.44	76	3003861	3.77	78
3003654Q	15.66	73	3003736	38.83	76	3003862 ^Δ	3.77	78
3003655	14.05	74	3003738Q ^Δ	53.73	76	3003863	3.78	78
3003656Q	17.90	73	3003739	51.54	76	3003865 ^Δ	4.78	78
3003657	13.99	74	3003740	53.43	76	3003866	8.98	78
3003658Q ^Δ	21.76	73	3003741 ^Δ	64.48	76	3003867 ^Δ	11.20	78
3003659 ^Δ	13.99	74	3003743	127.38	76	3003868	36.21	78
3003660Q ^Δ	23.38	73	3003755	60.48	76	3003869	10.55	77
3003661 ^Δ	20.52	74	3003756	59.99	76	3003870	10.71	77
3003662	18.13	73	3003776 ^Δ	73.02	76	3003871 ^Δ	10.71	77
3003663	16.10	74	3003777	81.06	76	3003872 ^Δ	25.29	77
3003664 ^Δ	17.37	73	3003791 ^Δ	142.76	72	3003873	34.07	77
3003665	16.65	74	3003792	19.78	72	3003874	3.77	78
3003666	17.84	73	3003796 ^Δ	5.84	70	3003905 ^Δ	10.03	77
3003667	16.65	74	3003797 ^Δ	5.84	70	3003908 ^Δ	12.15	78
3003668	17.84	73	3003798	4.30	70	3003910 ^Δ	12.15	78
3003669 ^Δ	17.20	74	3003800 ^Δ	6.33	70	3003912 ^Δ	12.15	78
3003670	18.02	73	3003801 ^Δ	6.33	70	3003913 ^Δ	12.15	78
3003671	16.05	74	3003803 ^Δ	6.51	70	3003917 ^Δ	28.66	78
3003672Q ^Δ	21.94	73	3003804 ^Δ	7.95	70	3003921 ^Δ	28.66	78
3003673 ^Δ	17.20	74	3003805 ^Δ	7.95	70	3003924 ^Δ	28.66	78
3003674	17.29	73	3003807 ^Δ	7.95	70	3003927 ^Δ	28.66	78
3003675	17.20	74	3003808	7.95	70	3003935 ^Δ	10.03	77
3003676 ^Δ	24.04	73	3003809	7.95	70	3003936 ^Δ	17.04	77
3003677	23.95	74	3003810	7.88	70	3003937 ^Δ	17.04	77
3003678Q	32.38	73	3003812 ^Δ	12.66	70	3003938 ^Δ	28.17	77
3003679 ^Δ	23.80	73	3003815	12.66	70	3003943	40.21	72
3003680 ^Δ	23.95	74	3003816	14.05	70	3003944	5.02	72
3003681Q ^Δ	29.40	73	3003817 ^Δ	14.05	70	3004372	190.30	88
3003683Q ^Δ	33.15	73	3003820	4.32	70	3004378	371.07	81
3003685	23.80	73	3003821	4.66	70	3004379	494.36	81
3003686 ^Δ	23.95	74	3003822Q ^Δ	5.36	70	3004380	437.14	81
3003687	88.54	74	3003823Q	5.36	70	3004381	545.16	81
3003688	82.78	73	3003824	6.15	70	3011162	53.14	91
3003689	89.45	74	3003825	6.17	70	3014918*	325.08	71
3003690 ^Δ	82.85	73	3003826	6.17	70	3017974*	210.09	76
3003691 ^Δ	68.37	74	3003827Q ^Δ	7.59	70	3017975*	269.96	76
3003698*	178.14	74	3003828	8.26	70	3017976*	326.07	76
3003702*	177.38	74	3003829	8.30	71	3017978*	331.01	72
3003704*	254.94	74	3003830	9.01	71	3017993	32.54	71
3003705*	298.18	73	3003831	8.79	71	3018002*	253.50	74
3003707Q ^Δ	248.95	73	3003832	9.01	71	3018003*	255.12	74
3003709*	329.98	73	3003833	9.02	71	3018005 ^Δ	42.72	72
3003710*	330.19	73	3003834	8.98	71	3018007 ^Δ	61.06	76
3003713 ^Δ	361.10	74	3003835	8.99	71	3018008	14.84	77
3003716 ^Δ	298.18	74	3003836Q ^Δ	14.95	71	3018025 ^Δ	89.85	78
3003718*	551.70	73	3003837Q	14.95	71	3018026 ^Δ	43.06	78
3003719*	558.54	73	3003838Q	14.95	71	3018027 ^Δ	43.06	78
3003723*	527.15	73	3003839	19.68	71	3018028 ^Δ	43.06	78
3003724	8.48	72	3003840	19.69	71	3018029 ^Δ	51.61	78
3003725Q	8.17	72	3003841	5.10	70	3018030 ^Δ	75.15	78

Numerical index

Cat no	Price £ per piece	Page no	Cat no	Price £ per piece	Page no	Cat no	Price £ per piece	Page no
3018031 ^Δ	396.62	78	3027854	116.96	88	3079759	6.32	81
3018297	347.00	81	3027855	98.42	88	3079760	8.17	81
3018299	490.62	81	3027856	88.63	88	3079761	8.94	81
3018300	397.90	81	3028271	310.44	88	3079762	15.12	81
3018301	545.47	81	3041228	60.27	81	3079763	14.81	81
3018302	693.97	81	3041229	97.19	81	3079764	23.75	81
3018704 ^Δ	4.65	78	3043453 ^Δ	54.91	71	3079768	5.67	82
3018705 ^Δ	6.06	78	3043454 ^Δ	63.21	71	3079769	7.13	82
3018706 ^Δ	6.06	78	3043455 ^Δ	103.62	71	3079770	10.12	82
3018707 ^Δ	7.04	78	3043457 ^Δ	148.63	71	3079771	15.78	82
3018708	1.13	78	3043503	291.63	78	3079772	30.89	82
3018709	1.27	78	3043504	383.25	78	3079773	12.08	82
3018710 ^Δ	7.04	78	3043505	398.78	78	3079774	17.55	82
3018804	539.96	81	3043506	585.31	78	3079775	33.63	82
3018808*	89.31	70	3053972	403.88	88	3079776	7.18	82
3018809*	234.67	70	3061202	1647.02	81	3079777	8.75	82
3018810*	325.08	70	3061211	22.02	81	3079778	12.62	82
3018811	144.37	71	3061212	31.68	81	3079779	14.07	82
3018812	143.02	71	3061213	48.07	81	3079780	15.73	82
3018813	143.02	71	3065639	122.39	88	3079781	25.10	82
3018815Q ^Δ	47.33	76	3065640	115.68	88	3079782	10.94	82
3018818*	198.36	72	3065641	112.47	88	3079783	13.86	82
3018819 ^Δ	483.08	72	3065642	130.35	88	3079784	16.90	82
3018820	114.67	71	3065643	132.64	88	3079785	18.90	82
3018821*	187.47	71	3065644	183.34	88	3079786	28.72	82
3018822 ^Δ	259.13	71	3065645	146.39	88	3079788	7.73	83
3018824Q ^Δ	193.08	73	3065646	141.02	88	3079789	7.87	83
3018826*	454.37	73	3065647	124.91	88	3079790	8.78	83
3018827 ^Δ	390.03	73	3065902	109.84	58	3079791	11.35	83
3018828*	526.81	73	3070529	404.98	81	3079793	15.00	83
3018829*	666.41	73	3070629	389.93	77	3079796	25.34	83
3018830 ^Δ	178.14	74	3070630*	267.11	73	3079797	37.41	83
3018831*	177.38	74	3070631*	126.32	76	3079798	5.69	83
3018832 ^Δ	253.50	74	3070632*	227.94	71	3079799	6.61	83
3018833*	255.86	74	3070633*	178.14	73	3079800	7.26	83
3018834 ^Δ	298.18	74	3070634*	186.04	73	3079801	8.03	83
3018835 ^Δ	298.18	74	3070827	35.13	81	3079802	9.18	83
3018836 ^Δ	301.00	74	3071219	323.17	81	3079803	11.94	83
3018837 ^Δ	300.13	74	3071220	371.07	81	3079804	17.50	83
3021196	114.23	91	3071221	494.36	81	3079805	26.28	83
3024667	48.27	88	3071222	344.98	81	3079806	28.83	83
3024668	52.81	88	3071224	437.14	81	3079811	7.71	82
3027829	69.08	88	3071225	545.16	81	3079812	11.03	82
3027830	50.42	88	3071226	404.98	81	3079813	15.85	82
3027831	56.83	88	3072765	291.63	78	3079814	27.01	82
3027832	36.50	88	3072958	12.87	81	3079815	44.21	82
3027833	37.05	88	3072989	18.43	81	3079816	18.60	83
3027834	40.80	88	3072990	28.06	81	3079817	20.75	83
3027837	42.38	88	3075609	54.13	70	3079818	21.57	83
3027842	52.97	88	3075823	51.38	74	3079819	19.29	83
3027847	96.27	88	3075824 ^Δ	11.91	71	3079820	26.81	83
3027848	108.79	88	3079754	4.55	81	3079821	10.10	82
3027849	119.64	88	3079755	5.93	81	3079822	10.10	83
3027850	97.81	88	3079756	8.90	81	3079823	10.10	83
3027852	93.13	88	3079757	15.49	81	3079824	10.10	82
3027853	130.36	88	3079758	24.67	81	3079825	14.01	83

Cat no	Price £ per piece	Page no	Cat no	Price £ per piece	Page no	Cat no	Price £ per piece	Page no
3079826	13.80	82	3080035	79.86	57	4012131	8.35	75
3079827	13.98	83	3080036	91.50	57	4012132	10.50	75
3079828	15.22	83	3080044	79.05	57	4012137	9.14	75
3079829	13.05	83	3080050	175.21	57	4012138	10.61	75
3079833	22.26	82	3080063	31.50	57	4012141	9.58	75
3079834	21.20	83	3080078	22.60	59	4012142	10.46	75
3079835	22.64	83	3080082	43.48	59	4012146	10.66	75
3079836	22.33	83	3080088	22.56	58	4012147	12.97	75
3079837	24.51	83	3080090	65.72	58	4012151	38.66	75
3079839	34.51	83	3080095	132.87	58	4012155	39.19	75
3079840	38.14	83	3080096	132.87	58	4012159	45.63	75
3079842	33.95	83	3080097	132.87	58	4012326	6.77	75
3079854	14.90	82	3080103	21.70	59	4012329	4.73	75
3079855	18.29	82	3080105	79.82	59	4012331	9.48	75
3079856	18.90	82	3080106	9.21	59	4012333 ^A	11.37	75
3079859	6.58	83	3082542	25.05	77	4012335	9.71	75
3079860	7.30	83	3083259	18.09	82	4012337	9.99	75
3079861	8.36	83	3084561	5.96	77	4012339	7.74	75
3079913	74.53	59	3084562	7.11	77	4012341 ^A	10.52	75
3079915	176.86	59	3084563	3.53	71	4012343	8.69	75
3079917	35.98	59	3084564 ⁱ	3.55	72	4012345	37.10	75
3079950	31.67	57	3084565	3.56	71	4013530	800.53	90
3079951	33.86	57	3084566 ⁱ	4.74	72	4013538	279.60	90
3079952	35.73	57	3084567	4.20	72	4013541	443.37	91
3079953	36.22	57	3084570	8.65	72	4013542	95.68	90
3079954	37.15	57	3084571	7.04	73	4013543	95.68	90
3079959	71.88	57	3084572	8.91	72	4013553	41.24	90
3079960	73.86	57	3084573	8.98	73	4013559	53.04	90
3079961	75.93	57	3084574	8.98	72	4013562	56.81	90
3079962	81.52	57	3084575	8.99	73	4013571	34.49	86
3079965	9.91	57	3084576	4.32	70	4013572	34.49	86
3079966	9.91	57	3084577	3.53	72	4013573	34.49	86
3079967	8.15	57	3090788	123.95	89	4020757	72.60	79
3079968	9.91	57	3090826	97.72	89	4023071	32.35	90
3079969	8.15	57	3090828	65.53	89	4023073	35.35	90
3079980	108.02	57	3090829	103.16	89	4023075	46.44	90
3079981	60.24	57	4009725	81.69	73	4023077	526.11	90
3079982	39.75	57	4009748	41.28	78	4023364	100.15	91
3079983	39.75	57	4009749 ^A	81.62	78	4023365	107.47	91
3079985	44.45	57	4009750 ^A	70.29	78	4023375	43.65	75
3079991	123.55	57	4009751 ^A	135.12	78	4023376	49.77	75
3079992	123.55	57	4009761 ^A	12.15	78	4024189	2663.05	79
3079994	170.54	57	4009793	8.37	78	4024190	3100.30	79
3079996	17.79	57	4011390	697.70	79	4024393	2663.05	79
3079997	17.79	57	4011393	713.43	79	4024432	2663.05	79
3080008	291.43	58	4011396	3384.85	79	4024493	2225.84	79
3080010	202.10	57	4011402 ^A	33657.66	79	4024569	2663.05	79
3080012	32.61	57	4011403	937.68	79	4025509	42.54	79
3080014	62.93	57	4011453	20.71	79	4025566	3.37	59
3080016	9.92	57	4012113	5.17	75	4025568	3.37	59
3080019	26.33	58	4012117	7.13	75	4025986 ^A	37.12	78
3080021	64.29	58	4012118	8.30	75	4025988 ^A	51.71	78
3080023	13.72	58	4012121 ^A	7.48	75	4025989 ^A	37.12	78
3080026	42.28	57	4012122	9.09	75	4025992 ^A	232.61	78
3080030	47.06	57	4012125	7.78	75	4026102	85.74	59
3080034	71.56	57	4012126	9.17	75	4026106	127.91	59

Numerical index

Cat no	Price £ per piece	Page no	Cat no	Price £ per piece	Page no	Cat no	Price £ per piece	Page no
4026109	275.11	59	4063770 ^Δ	30.36	75	4066001	11.37	84
4026438	32.61	75	4063772	51.01	75	4066003	12.34	84
4026439 ^Δ	33.85	75	4063971	7.78	84	4066004	16.58	84
4026441 ^Δ	166.47	75	4063972	9.72	84	4066005	22.36	84
4026442 ^Δ	346.11	75	4063974	15.38	84	4066007	36.14	84
4026689	27.56	86	4064166	23.32	84	4066009	11.76	84
4026690	36.04	86	4064167	54.09	84	4066011	12.82	84
4026691	49.82	86	4064182	9.21	84	4066012	17.34	84
4026692	32.33	86	4064185	13.36	84	4066013	24.00	84
4026693	45.58	86	4064190	19.61	84	4066015	36.62	84
4026694	63.18	86	4064193	45.46	84	4066028	9.16	85
4026699	6.36	86	4064199	8.53	84	4066029	18.31	85
4028869	0.83	110	4064200	11.49	84	4066030	10.89	85
4031987	184.36	91	4064202	19.10	84	4066031	15.22	85
4031988	179.94	91	4064204	28.74	84	4066033	17.54	85
4035779	744.69	91	4064205	88.23	84	4066034	26.40	85
4035780	266.51	91	4064235	17.30	85	4066035	32.48	85
4036272	53.14	91	4064239	29.74	85	4066041	7.53	85
4036273	109.86	90	4064262	8.34	85	4066042	9.16	85
4036330	3717.79	79	4064271	20.36	85	4066043	11.56	85
4037386	21.49	90	4064273	20.96	85	4066044	14.94	85
4042219 ^Δ	487.43	72	4064274	36.51	85	4066045	25.92	85
4042914	2225.84	79	4064276	41.33	85	4066046	17.15	85
4042915	230.53	79	4064277	9.03	87	4066067	20.79	85
4043224	242.69	90	4064278	8.60	87	4066068	21.20	85
4043225	259.68	90	4064279	11.07	87	4066072	9.16	85
4046556	281.02	91	4064280	16.15	87	4066074	9.16	85
4046557	281.02	91	4064281	18.78	87	4066076	10.17	85
4046558	309.12	91	4064282	24.73	87	4066078	35.27	85
4046559	309.12	91	4064283	26.82	87	4066079	21.76	85
4046560	449.62	91	4064315	42.12	85	4066082	31.64	85
4046691	323.17	91	4064323	12.08	84	4066095	38.16	84
4046694	323.17	91	4064324	17.57	84	4066097	60.42	84
4046695	337.22	91	4064326	27.04	84	4066099	108.70	84
4046756	337.22	91	4064328	41.33	84	4066133	14.83	85
4046758	477.72	91	4064329	107.66	84	4066449	11.23	59
4046759	505.82	91	4064354	17.83	84	4066452	16.05	59
4048906	2810.11	90	4064361	25.69	84	4066454	24.83	59
4048907	4496.17	90	4064371	38.37	84	4066723	245.88	90
4049179	167.83	89	4064881	347.18	77	4066725	477.72	91
4053507	283.27	91	4064882	395.08	77	4067485	23.32	86
4053508	111.84	90	4064999	7679.01	79	4081515	8.12	77
4053509	533.92	91	4065000	380.50	79	4081516	8.30	77
4053510	519.88	91	4065001	380.50	79	4081517	8.31	77
4055036	6.57	87	4065138	26.33	59	4081518	8.58	77
4061068	207.47	77	4065141	26.33	59	4081519	11.95	77
4063088 ^Δ	12.80	75	4065143	26.33	59	4081520	11.64	77
4063089 ^Δ	12.97	75	4065145	3.37	59	4081521	12.22	77
4063090 ^Δ	7.31	75	4065188	2.81	59	4081522	21.61	77
4063092 ^Δ	6.77	75	4065190	6.89	59	4081523	27.97	77
4063093 ^Δ	9.71	75	4065192	3.37	59	4999998	94.02	91
4063094 ^Δ	9.09	75	4065978	11.83	86	4999999	95.27	91
4063766	23.88	75	4065979	12.75	86	BV1/21 WH	58.61	53
4063767	23.88	75	4065981	16.23	86	BV1 WH	43.34	53
4063768	23.88	75	4065982	23.70	86	BV3 WH	10.42	53
4063769	30.36	75	4065983	26.45	86	BV11 WH	10.94	53

Cat no	Price £ per piece	Page no	Cat no	Price £ per piece	Page no	Cat no	Price £ per piece	Page no
CV1 WH	43.34	53	HD25B/22W	7.70	97	HX30/28W	12.96	100
CV3 WH	10.42	53	HD26A/10W	6.11	97	HX31/15W	5.36	100
CV11 WH	10.94	53	HD26A/15W	5.08	97	HX31/22W	8.83	100
dMEVCS001	144.18	118	HD26B/15W	6.11	97	HX31/28W	12.96	100
dMEVCS002	154.30	118	HD26B/22W	6.60	97	HX32/15 GY	9.62	100
FBP3 WH	52.08	54	HD27/15W	6.64	97	HX35/15W	15.05	101
FBP6 WH	104.05	54	HD62/10W	5.13	94	HX35/22W	21.43	101
FCP3 WH	52.08	54	HD62/15W	4.59	94	HX36/15W	26.90	101
FCP6 WH	104.05	54	HD62/22W	5.78	94	HX36/22W	28.93	101
FCW6 WH	4.24	54	HD62/28W	9.62	94	HX37/15W	13.45	101
FSBW6 WH	4.24	54	HD74 GR	26.72	105	HX38/15W	12.78	101
FSCW6 WH	4.24	54	HD75 GR	65.87	105	HX39 GR	4.98	100
HD1/10W	5.78	94	HD78 GR	67.38	105	HX43/22W	35.34	101
HD1/15W	3.46	94	HD125A/15W	10.61	98	HX44/10W	1.81	96
HD1/22W	4.87	94	HD125B/15W	12.56	98	HX44/15W	2.11	96
HD1/28W	14.01	94	HD125B/22W	12.56	98	HX44/22W	2.11	96
HD2/15W	5.99	95	HD125D/15W	13.46	98	HX44/28W	2.53	96
HD2/22W	4.63	95	HD125E/15W	28.83	99	HX57/15 GRp/pack 7.06	106	106
HD2/28W	11.23	95	HD125EH/15W	28.83	99	HX57/22 GRp/pack 7.06	106	106
HD3B/15W	10.89	95	HD125F/15W	18.98	99	HX58/15 Gy p/pack 7.06	106	106
HD3B/22W	9.49	95	HD125G/15W	18.98	99	HX58/22 Gy p/pack 7.06	106	106
HD3C/22W	10.89	95	HD125H/15W	12.47	98	HX60/10W	0.82	94
HD4/10W	6.55	94	HD125H/22W	15.24	98	HX60/15W	0.83	94
HD4/15W	4.42	94	HD225A/15W	14.54	98	HX60/22W	1.08	94
HD4/22W	6.55	94	HD225B/15W	16.43	98	HX60/28W	1.60	94
HD4A/15W	6.55	94	HD225B/22W	17.47	98	HX65/10W	0.31	105
HD5/10W	6.55	94	HD225E/15W	31.55	99	HX65/15W	0.50	105
HD5/15W	4.20	94	HD225H/15W	18.26	98	HX65/22W	0.50	105
HD5/22W	6.16	94	HD225H/22W	21.09	98	HX65/28W	0.60	105
HD5/28W	16.77	94	HD425A/15W	10.05	98	HX75/15 GR	3.22	105
HD8/10W	7.07	95	HRU220VL	1568.78	118	HX75/22 GR	4.54	105
HD8/15W	4.91	95	HRU220VR	1568.78	118	HX77/10W	3.16	105
HD8/22W	7.07	95	HRU300H1	1879.45	118	HX77/15W	2.59	105
HD10/10W	8.09	94	HRU300H2	1879.45	118	HX78/10W	0.47	105
HD10/15W	5.90	94	HRU360VL	1737.23	118	HX78/15W	0.52	105
HD10/22W	8.09	94	HRU360VR	1737.23	118	HX78/22W	0.52	105
HD10/28W	23.14	94	HX6/15W	14.84	100	HX78/28W	0.59	105
HD12/22W	8.56	95	HX6/22W	16.13	100	HX79/10W	0.52	105
HD12/28W	23.14	95	HX18/15W	14.80	101	HX79/15W	0.60	105
HD13/15W	8.56	96	HX19/15W	15.48	101	HX79/22W	0.60	105
HD13/22W	8.56	96	HX20/15W	5.00	96	HX79/28W	0.68	105
HD13/28W	23.14	96	HX20/22W	6.29	96	HX81 GR	772.39	105
HD13A/22W	8.56	96	HX20/28W	28.15	96	HX85/15W	0.50	105
HD13A/28W	23.14	96	HX22/15W	19.00	101	HX85/22W	0.50	105
HD14/15W	8.56	96	HX22/22W	24.81	101	HX85/28W	0.83	105
HD14/22W	8.56	96	HX24/15W	13.82	100	HX86/15W	0.37	105
HD14/28W	23.14	96	HX28/10W	9.88	100	HX86/22W	0.50	105
HD14A/22W	8.56	96	HX28/15W	9.62	100	HX88/22W	11.54	102
HD15/15W	8.56	96	HX28/22W	13.82	100	HX88B/22W	11.93	102
HD15/22W	8.56	96	HX28/28W	27.16	100	HX89/22W	15.50	102
HD18/15W	8.56	95	HX29/10W	9.88	100	HX89B/22W	16.07	102
HD18/22W	8.56	95	HX29/15W	9.62	100	HX91T/22W	32.28	103
HD18/28W	23.14	95	HX29/22W	13.82	100	HX92/22W	11.54	103
HD18A/22W	9.05	95	HX29/28W	26.26	100	HX92B/22W	12.62	102
HD25A/15W	6.01	97	HX30/15W	5.25	100	HX92T/15W	54.21	103
HD25B/15W	7.11	97	HX30/22W	8.83	100	HX93T/15W	79.50	104

Numerical index

Cat no	Price £ per piece	Page no	Cat no	Price £ per piece	Page no	Cat no	Price £ per piece	Page no
HX94/22W	15.50	103	KL1-28	14.01	94	KL89-22	15.50	102
HX94B/22W	16.07	102	KL2-15	5.99	95	KL89B-22	16.07	102
HX94T/15W	108.54	104	KL2-22	4.63	95	KL92-22	11.54	103
HX95A GR	31.07	104	KL2-28	11.23	95	KL92B-22	12.62	102
HX95A GR•	31.07	86	KL3B-15	10.89	95	KL94-22	15.50	103
HX96/22W	17.72	103	KL3B-22	9.49	95	KL94B-22	16.07	102
HX96B/22W	17.72	103	KL3C-22	10.89	95	KL96-22	17.72	103
HX97 GY	4.73	104	KL4-10	6.55	95	KL96B-22	17.72	103
HX97 GY•	4.73	86	KL4-15	4.42	95	KL125A-15	10.61	98
HX98 GY	5.48	104	KL4-22	6.55	95	KL125B-15	12.56	98
HX98 GY•	5.48	86	KL4A-15	6.55	95	KL125B-22	12.56	98
HX100 BL	9.32	106	KL5-10	6.55	94	KL125D-15	13.46	98
HX101/15W	12.97	106	KL5-15	4.20	94	KL125E-15	28.83	99
HX103 BL	2.59	106	KL5-22	6.16	94	KL125EH-15	28.83	99
HX104 BL	3.13	106	KL5-28	16.77	94	KL125F-15•	18.98	99
HX109 GY	5.00	104	KL6-15	14.84	100	KL125G-15•	18.98	99
HX110 GY	4.19	104	KL6-22	16.13	100	KL125H-15	12.47	98
HX112 GY	0.28	104	KL8-10	7.07	95	KL125H-22	15.24	98
HX113 WH	10.98	104	KL8-15	4.91	95	KL225A-15	14.54	98
HX200	18.37	106	KL8-22	7.07	95	KL225B-15	16.43	98
HXC25/15 BL	56.16	106	KL10-10	8.09	94	KL225B-22	17.47	98
HXC25/22 BL	70.28	106	KL10-15	5.90	94	KL225E-15	31.55	99
HXC50/15 BL	112.41	106	KL10-22	8.09	94	KL225H-15	18.26	98
HXC50/22 BL	139.81	106	KL10-28	23.14	94	KL225H-22	21.09	98
HXX03/15W	11.33	93	KL12-22	8.56	95	KL425A-15	10.05	98
HXX03/22W	22.14	93	KL12-28	23.14	95	KLB20-28HX	28.15	96
HXX03/28W	30.37	93	KL13-15	8.56	96	KLB22-15	19.00	101
HXX06/15W	23.36	93	KL13-22	8.56	96	KLB22-22	24.81	101
HXX06/22W	45.85	93	KL13-28	23.14	96	KLB24-15	13.82	100
HXX06/28W	62.52	93	KL13A-22	8.56	96	KLB28-10	9.88	100
HXX10/15W	36.17	93	KL13A-28	23.14	96	KLB28-15	9.62	100
HXX10/22W	70.57	93	KL14-15	8.56	96	KLB28-22	13.82	100
HXX10/28W	95.14	93	KL14-22	8.56	96	KLB28-28	27.16	100
HXX25/10W	76.81	93	KL14-28	23.14	96	KLB29-10	9.88	100
HXX25/15W	90.35	93	KL14A-22	8.56	96	KLB29-15	9.62	100
HXX25/22W	176.38	93	KL15-15	8.56	96	KLB29-22	13.82	100
HXX25/28W	237.83	93	KL15-22	8.56	96	KLB29-28	26.26	100
HXX50/10W	151.30	93	KL18-15	8.56	95	KLB35-15	15.05	101
HXX50/15W	178.82	93	KL18-22	8.56	95	KLB35-22	21.43	101
HXX50/22W	349.25	93	KL18-28	23.14	95	KLB91T-22	32.28	103
HXX50/28W	473.41	93	KL20-15	5.00	96	KLB92T-15	54.21	103
HXX80/15W	286.12	93	KL20-22	6.29	96	KLB93T-15	79.50	104
HXX100/10W	298.06	93	KL25A-15	6.01	97	KLB94T-15	108.54	104
HXX100/15W	352.12	93	KL25B-15	7.11	97	S170 WH	78.85	54
HXX120/15W	422.56	93	KL25B-22	7.70	97	S171 WH	75.58	54
HXXC2528 BU	457.58	93	KL26A-10	6.11	97	S172 WH	72.32	54
HXXC2528 RD	457.58	93	KL26A-15	5.08	97	S951 BL	57.11	54
HXXC5010 BU	314.25	93	KL26B-15	6.11	97	UFHC1-12	278.94	108
HXXC5010 RD	314.25	93	KL26B-22	6.60	97	UFHC1-15	295.07	108
HXXC5015 BU	361.33	93	KL27-15	6.64	97	UFHC1-20	366.36	108
HXXC5015 RD	361.33	93	KL62-10	5.13	94	UFHC1-30	382.49	108
HXXC5022 BU	555.81	93	KL62-15	4.59	94	UFHC2-15	609.40	108
HXXC5022 RD	555.81	93	KL62-22	5.78	94	UFHC2-20	625.54	108
KL1-10	5.78	94	KL62-28	9.62	94	UFHC2-30	696.83	108
KL1-15	3.46	94	KL88-22	11.54	102	UFHC2-40	712.96	108
KL1-22	4.87	94	KL88B-22	11.93	102	UFHC6-40	995.89	108

Cat no	Price £ per piece	Page no
UFHC6-60	1356.64	108
UFHC6-80	1699.87	108
UFHC8-12	954.55	108
UFHC8-15	1078.34	108
UFHC8-20	1239.59	108
UFHC8-30	1685.91	108
VCONT001	190.09	118
WC004W	30.33	37
WC204W	37.00	37
WC404W	37.07	37
WC904W	43.23	37

Important notes

All purchases are subject to our standard terms and conditions of sale, available at www.wavin.co.uk/general-conditions or call for a copy.

Prices are subject to VAT at the current rate.

Wavin operates a programme of continuous product development, and therefore reserves the right to modify or amend the specification of their products without notice. All information in this publication is given in good faith, and believed to be correct at the time of going to press. However, no responsibility can be accepted for any errors, omissions or incorrect assumptions. Users should satisfy themselves that products are suitable for the purpose and application intended.

Quality assurance

Wavin manufacturing sites operate Environmental Management Systems which comply with the requirements of and are certified to EN ISO 14001:2015, Certificate No. 42231.

All Wavin products are manufactured under a quality management system which is approved to BS EN ISO 9001:2015.

Orders and enquiries

Tel: 0800 038 0088

For further information on our product ranges, see the following:

Wavin website

www.wavin.co.uk is the place to find overview of our ranges, individual item information (such as photo, dimensions, etc), literature via our download centre, news and events, blogs, online calculation tools, links to 'How to Videos' and more.

Download centre on wavin.co.uk

Visit our website download centre for electronic copies of:

- Product, Design and Installation Guides
- Price list
- Safety sheets
- Quality certificates
- CAD files, etc.

'How to' videos

To support Osma, Hep₂O Plumbing & Heating and Wavin brands, there are a series of 'How to' videos to show how you can make light work of installation problems. They can be viewed at youtube.com/WavinUK

YouTube



Online Tools and E-Learning

We have lots of resources available to help you with your projects. Our e-learning modules will bring you up to date on our products and the latest regulations. You can also access a number of calculation tools – and all for free. Just visit myportal.wavin.co.uk

Wavin knowledge centre

Keep ahead of breaking news with a fresh and insightful look into the construction industry. Our aim is to keep you informed and up to date with the latest how-to guides, regulations, innovation and more. Visit blog.wavin.co.uk

BIM centre

Register on myportal.wavin.co.uk for access to our Revit content package, which helps you create accurate designs and generate a comprehensive bill of materials.

X accounts

Join the conversation:



@WavinUK
@Hep2O

Contact

Orders and enquiries:
Complex technical queries:
General enquires:

0800 038 0088
technical.design@wavin.co.uk
info@wavin.co.uk

NEW Hep₂O Keyless

50
Year
Guarantee

Smaller,
slimmer
fitting.....

Optimised
flow rate.....

Compatible
with other
systems.....

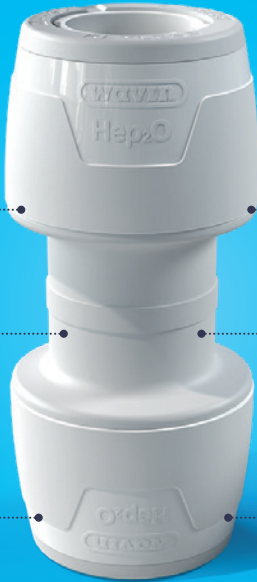

Pre-locked
for speedier
installation

In4Sure
technology



Simply twist
to unlock
and lock

With two great
Hep₂O systems to
choose from, to
key or not to key
is now the only
question?



Scan
for your
FREE
sample pack



Wavin Limited
Registered Office
Edlington Lane
Doncaster | DN12 1BY
Tel. 0800 038 0088
www.wavin.co.uk | info@wavin.co.uk



An Orbia business.

January 2025