

wavin Hep₂O OSMA

NEW



Trade Price List Above Ground Systems

1st February 2023 – Revision 7

www.wavin.co.uk

Pack quantity notice

Products which are supplied in pack multiples, but can also be ordered in singles are highlighted in a darker shade as follows:

Pack qty
5
5
5
5

Contents

	Page		Page
Introduction to Wavin Osma	2	Wavin Solvent Soil and Waste	61-70
Wavin Osma Rainwater	4-21	PVC-U Solvent Soil	61-66
RoundLine	4-9	Problem Solvers	67
SquareLine	10-14	PVC-C Solvent Weld waste	68-69
StormLine	15-16	Wavin HDPE	70-79
DeepLine	17-18	Soil, waste and vent	70-79
SuperLine	19-20	Introduction to Wavin Tigris	80
RoofLine	21-22	Wavin Tigris K5/M5	81-87
Wavin OsmaSoil	23-40	Wavin Tigris K1/M1	88-89
Soil and Vent PVC-U		Accessories and tools	90-91
Ring-seal system	23-31	Introduction to Wavin Hep₂O Push-fit plumbing	92
Soil and Vent PVC-U		Wavin Hep₂O Push-fit plumbing	93-106
Solvent Weld system	32-36	Polybutylene pipe	93
WC connectors	37-38	Demountable fittings	94-97
WC connectors – Easy-fit	38	Flexible tap connectors – braided	98-99
Ancillaries	39-40	Auxiliary fittings	100-104
Wavin OsmaWeld	41-44	Tools, fixings and accessories	105-106
ABS Solvent Weld waste	41-44	Conduit system	106
Wavin Osma Waste	45-51	Introduction to Wavin Indoor Climate Solutions	107
PP Push-fit waste	45-47	Wavin Indoor Climate Solutions	108-117
Waste connectors and V-Joint traps	48-50	UFH – Polybutylene pipe	108
Condensate drainage	51	UFH – Floor fixings and accessories	108
Wavin Osma Overflow	52	UFH – Manifolds	109-110
ABS / PVC-U Solvent Weld and PP Push-fit	52-53	UFH – Panel Systems	111
Wavin Osma Hep₂O	54	UFH – Control Systems	112-113
Hygienic self-sealing waste valves – Polypropylene	54	UFH – Heat Interface Units	114
Wavin Osma Problem Solvers	55	MVHR Units	115
Flexible Waste pipe	55	Numerical index	116-130
Flexible soil pipe	55	Notes	131
Condensate fitting	55	Important notes	132
Introduction to Wavin Industrial and Commercial systems	56		
Wavin Industrial and Commercial systems	58-92		
Wavin AS+	58-60		
Acoustic Soil system – Astolan® and PVC-U	58-60		



All 110/160mm PVC-U soil pipe is manufactured using Wavin's Recycore Technology but has exactly the same performance and handling characteristics as virgin pipe.

Introduction to



Wavin Osma Above Ground Drainage systems, form part of a comprehensive range of plastic systems to provide intelligent solutions for all building, construction and utilities projects.

Key to abbreviations

B	Black	E	Olive
N	Brown	W	White
G	Grey	AG	Anthracite Grey

P/E – Pipe and fittings with both ends plain or with one plain end and one special end.

S/S – Pipe and fittings with one or more ring-seal or push-fit sockets, but always one plain or special end.

D/S – Fittings with ring-seal or push-fit sockets at all ends.

S/SW – Fittings with one or more ring-seal sockets but always one solvent socket.

SW/S – Fittings with one or more solvent sockets and one plain or special end.

D/SW – Fittings with solvent sockets at all ends.

Symbols

British Standards Kitemark

Identifies pipe and fittings manufactured under the BSI Kitemark Certification Scheme.

British Board of Agrément

BBA Logo Identifies non-Kitemarked fittings covered by a British Board of Agrément Certificate.

WRAS Water Regulations Advisory Scheme

Identifies pipe and fittings that are WRAS approved.

Important notes:

All Wavin Osma Soil, Waste and Overflow fittings must be ordered in their pack multiples as illustrated in price list, unless the pack quantity is highlighted in a darker shade which indicates they can be ordered in singles.

Product photos are for example only and not representative of every fitting size.

Email: info@wavin.co.uk Web: www.wavin.co.uk  @WavinUK

Acceptance

a) British Standards Institution

♥ Wavin Osma Above Ground Drainage Systems comply, where applicable, with the requirements of the following British Standards:

BS 4576: Part 1: 1989 - Half-round gutters and pipes of circular cross section.

BS EN 1329-1: 2000, BS 4514: 2001 - Unplasticized PVC soil and ventilating pipes, fittings and accessories.

BS EN 1451-1: 2000 - Polypropylene waste pipe and fittings.

BS 5255: 1989 - Thermoplastics waste pipe and fittings.

BS EN 1566-1: 2000 – Plastic piping systems for soil and waste discharge (low and high temperature) within the building structure - Chlorinated poly (vinyl chloride) (PVC-C).

BS 6209: 1982 - Solvent cement for non pressure thermoplastics pipe systems.

BS EN 607: 2004 - Eaves, gutters and fittings made of PVC-U definitions, requirements and testing.

BS EN 1462: 2004 - Brackets for eaves gutters: requirements and testing.

BS EN 12200-1: 2000 - Plastics rainwater piping systems for above ground external use - unplasticized Poly Vinyl Chloride (PVC-U) - Part 1 specifications for pipes, fittings and the system.

BS EN 1455-1: 2000 - Plastic piping systems for soil and waste (low and high temperature) within the building structure - Acrylonitrile-butadiene-styrene (ABS).

BS EN 12380:2002 - Air admittance valves for drainage systems. Requirements, test methods and evaluation of conformity.

BS 5254:1976 - Specification for polypropylene waste pipe and fittings (external diameter 34.6 mm, 41.0 mm and 54.1 mm).

BS EN 1453-1:2000 - Plastics piping systems with structured-wall pipes for soil and waste discharge (low and high temperature) inside buildings. Unplasticized poly (vinyl chloride) (PVC-U). Specifications for pipes and the system.

b) British Board of Agrément

▲ The Wavin OsmaSoil system has been awarded the following certificates:

86/1643 OsmaVent 110 and OsmaVent 40 Air Admittance Valves.

89/2174 OsmaSoil 110mm Adjustable Bends.

c) WRAS

Wavin Hep₂O is approved (certificate 1901900) – deemed safe for use in the supply of drinking water.











The Silicone Lubricant Spray has WRAS approval for use with potable water.











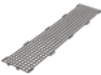

All 110/160mm PVC-U soil pipe is manufactured using Wavin's Recycore Technology but has exactly the same performance and handling characteristics as virgin pipe.

Wavin Osma RoundLine







Rainwater half round domestic – PVC-U

Description		Nom dia mm	Cat no	Pack qty	Price £ per piece	
	Gutter					
	Gutter – 2.0m					
	▽	112	OT072B	5	38.49	
	▽	112	OT072G	5	38.49	
	▽	112	OT072W	5	38.49	
	▽	112	OT072N	5	38.49	
	Gutter – 4.0m					
	▽	112	OT074B	5	76.55	
	▽	112	OT074G	5	76.55	
	▽	112	OT074W	5	76.55	
	▽	112	OT074N	5	76.55	
	Gutter Union and Brackets					
	Gutter Jointing Bracket					
	▽	112	OT005B	10	12.43	
	▽	112	OT005G	5	12.43	
	▽	112	OT005W	5	12.43	
	Gutter Union					
	▽	112	OT009B	10	16.61	
	▽	112	OT009G	5	16.61	
	▽	112	OT009W	5	16.61	
	Gutter Support Bracket					
	▽	112	OT019B	40	5.48	
	▽	112	OT019G	20	5.48	
	▽	112	OT019W	40	5.48	
	Gutter Bracket Spacer – 21mm projection					
	▽	–	OT044B	20	6.74	
		Angled Bracket Spacer				
		▽	–	OT045B	10	15.56
Outlets and Stopends						
	Running Outlet – straight					
	▽	112	OT624B	5	25.13	
	▽	112	OT624G	5	25.13	
	▽	112	OT624W	5	25.13	
	Swivelock Running Outlet – with fitted offset bend					
	▽	112	OT624N	5	25.13	
	▽	112	OT625B	2	38.31	
		Stopend Outlet				
▽		112	OT007B	5	30.92	
▽		112	OT007G	5	30.92	
▽		112	OT007W	5	30.92	
	Stopend – internal					
	▽	112	OT007N	5	30.92	
	▽	112	OT010B	5	7.96	
	▽	112	OT010G	5	7.96	
	▽	112	OT010W	5	7.96	
	▽	112	OT010N	5	7.96	











Description		Nom dia mm	Cat no	Pack qty	Price £ per piece
	Stopend – external	112	OT011B	10	10.25
	▽	112	OT011G	5	10.25
	▽	112	OT011W	5	10.25
	▽	112	OT011N	5	10.25
Gutter Angles					
	Angle – 90°	112	OT003B	5	23.78
	▽	112	OT003G	5	23.78
	▽	112	OT003W	5	23.78
	▽	112	OT003N	5	23.78
	Angle – 60°	112	OT016B	5	32.78
	Angle – 45°	112	OT004B	5	31.10
	▽	112	OT004G	5	31.10
	▽	112	OT004W	5	31.10
	▽	112	OT004N	5	31.10
	Fabricated angles to order	112	OT999B	1	129.73
		112	OT999G	1	129.73
		112	OT999W	1	129.73
		112	OT999N	1	129.73
	Leaf Guard Leaf Guard – 10 no. x 500mm	–	OT017B	1	73.13
Connectors to Metal and PVC-U Gutters					
	Connector to 4" or 4.5" CI Half-round Gutter	112	OT008B	10	27.88
	Connector to 4.5" CI Ogee Gutter – LH	112	OT014B	5	47.75
	Connector to 4.5" CI Ogee Gutter – RH	112	OT015B	5	47.75
Rise and Fall Brackets and Spikes					
	Bow and Pin	112	OT914B	10	23.53
	– for Rise and Fall Brackets	112	OT914G	10	23.53
	(for use with Build-in or Drive-in Spikes)	112	OT914W	10	23.53
		112	OT914N	10	23.53
	Build-in Spike	–	OT985B	10	16.74
	– 200mm long	–	OT986B	10	25.14
	– 300mm long				
	Drive-in Spike	–	OT988B	10	13.96
	– 200mm long	–	OT989B	10	18.74
	– 300mm long				

Wavin Osma RoundLine

Rainwater half round domestic – PVC-U

Description	Nom dia mm	Cat no	Pack qty	Price £ per piece
Rafter Brackets (PVC coated steel)				
 Top Rafter Bracket – 300mm long	112	OT745B	20	30.19
 Side Rafter Bracket – 300mm long	112	OT746B	20	32.67
Rafter Bracket (BZP)				
 Adjustable Top Rafter Bracket – 300mm long	–	OT147G	20	36.02
 Adjustable Side Rafter Bracket – 300mm long	–	OT148G	20	33.26
Rafter Bracket (galvanised)				
 Top Rafter Bracket – 300mm long galvanised	112	OT245B	5	30.70
 Side Rafter Bracket – 300mm long galvanised	112	OT246B	5	30.70
Pipe				
 P/E Pipe – 2.0m	68	OT082B	5	43.16
	68	OT082G	5	43.16
	68	OT082N	5	43.16
P/E Pipe – 2.75m	68	OT086B	5	60.37
	68	OT086G	5	60.37
	68	OT086W	5	60.37
	68	OT086N	5	60.37
	68	OT086AG	5	60.37
	P/E Pipe – 4.0m	68	OT084B	5
68		OT084G	5	86.27
68		OT084W	5	86.27
68		OT084N	5	86.27
68		OT084AG	5	86.27
P/E Pipe – 5.5m		68	OT088B	5
	68	OT088G	5	112.67
	68	OT088W	5	112.67
	68	OT088N	5	112.67
	68	OT088AG	5	112.67









Note: Anthracite Grey (AG) gutter available in DeepLine profile only.

Description		Nom dia mm	Cat no	Pack qty	Price £ per piece
Pipe and Socket Brackets					
	Pipe or Socket Bracket	68	OT033B	10	13.59
	▽	68	OT033G	5	13.59
	▽	68	OT033W	5	13.59
	▽	68	OT033N	5	13.59
	▽	68	OT033AG	5	13.59
	Pipe Bracket	68	OT034B	20	9.47
	▽	68	OT034G	5	9.47
	▽	68	OT034W	5	9.47
	▽	68	OT034N	5	9.47
	▽	68	OT034AG	5	9.47
	Socket Bracket	68	OT038B	10	11.10
	▽	68	OT038G	10	11.10
	▽	68	OT038W	10	11.10
	▽	68	OT038N	10	11.10
	▽	68	OT038AG	10	11.10
	Drive-in Pipe Bracket	68	OT143B	10	31.56
	▽				
	Pipe Bracket Spacer – for use with OT033	68	OT031B	10	4.51
	Bracket Extension Piece – for use with OT033	68	OT030B	5	5.29
	▽				
Connectors and Adaptors					
	Pipe Connector	68	OT024B	5	11.58
	▽	68	OT024G	5	11.58
	▽	68	OT024W	5	11.58
	▽	68	OT024N	5	11.58
	▽	68	OT024AG	5	11.58
	Connector to 2.5" CI RW pipe	68	OT092B	5	28.56
	▽				
	Rainwater Adaptor – 68mm pipe to 110mm PVC-U drain	–	4S149	10	24.05
	Rainwater Adaptor – 68mm pipe to 110mm PVC-U drain	–	OT149B	5	30.22
	▽				
	Universal Drain Adaptor	–	4S159	10	25.63





Note: Anthracite Grey (AG) gutter available in DeepLine profile only.

Wavin Osma RoundLine

Rainwater half round domestic – PVC-U

Description		Nom dia mm	Cat no	Pack qty	Price £ per piece
Bends and Shoe					
	Offset Bend – socket	68	OT025B	10	14.51
	▽	68	OT025G	5	14.51
	▽	68	OT025W	5	14.51
	▽	68	OT025N	5	14.51
	▽	68	OT025AG	5	14.51
	Offset Bend – spigot	68	OT026B	10	18.04
	▽	68	OT026G	5	18.04
	▽	68	OT026W	5	18.04
	▽	68	OT026N	5	18.04
	▽	68	OT026AG	5	18.04
	Long Tail Offset Bend – spigot	68	OT027B	5	22.51
	Pipe Bend – 87.5°	68	OT161B	5	27.98
	▽	68	OT161G	5	27.98
	▽	68	OT161W	5	27.98
	▽	68	OT161N	5	27.98
	▽	68	OT161AG	5	27.98
	Pipe Shoe	68	OT037B	5	15.71
	▽	68	OT037G	5	15.71
	▽	68	OT037W	5	15.71
	▽	68	OT037N	5	15.71
	▽	68	OT037AG	5	15.71
Branch, Access Pipe and Hopper Head					
	Pipe Branch – 67.5°	68	OT035B	5	47.20
	▽	68	OT035G	5	47.20
	▽	68	OT035W	5	47.20
	▽	68	OT035N	5	47.20
	▽	68	OT035AG	5	47.20
	Access Pipe – with screwed door	68	OT274B	5	85.20
	▽	68	OT274G	5	85.20
	▽	68	OT274W	5	85.20
	▽	68	OT274N	5	85.20
	▽	68	OT274AG	5	85.20
	Hopper Head	68	OT332B	5	63.38
	▽	68	OT332G	5	63.38
	▽	68	OT332W	5	63.38
	▽	68	OT332N	5	63.38
	▽	68	OT332AG	5	63.38











Note: Anthracite Grey (AG) gutter available in DeepLine profile only.









Description		Nom dia mm	Cat no	Pack qty	Price £ per piece
	Rainwater Diverter	68	OT201B	1	99.40
	Rainwater Diverter Kit	68	OT201W	1	99.40
Spares					
	Gutter Seal	112	OT064G	5	4.21
	Flexiclip	112	OT116B	1	3.07
	▽	112	OT116G	1	3.07
	▽	112	OT116W	1	3.07
	▽	112	OT116N	1	3.07
	Gutter Pad – narrow	112	OT060B	5	4.21
	Gutter Pad – wide	112	OT061B	5	4.21

Note: Anthracite Grey (AG) gutter available in DeepLine profile only.

Wavin Osma SquareLine











Rainwater square – PVC-U











Description		Nom dia mm	Cat no	Pack qty	Price £ per piece
Gutter					
	Gutter – 2.0m				
	♥	100	4T872B	5	40.83
	♥	100	4T872W	5	40.83
♥	100	4T872N	5	40.83	
Gutter – 4.0m					
♥	100	4T874B	5	81.70	
♥	100	4T874W	5	81.70	
♥	100	4T874N	5	81.70	
Gutter Union and Brackets					
Gutter Jointing Bracket					
	♥	100	4T805B	20	16.12
	♥	100	4T805W	20	16.12
	♥	100	4T805N	20	16.12
Gutter Union					
	♥	100	4T809B	10	25.73
	♥	100	4T809W	5	25.73
	♥	100	4T809N	5	25.73
Gutter Support Bracket					
	♥	100	4T819B	20	6.94
	♥	100	4T819W	20	6.94
	♥	100	4T819N	20	6.94
Gutter Bracket Spacer – 21mm projection					
		–	0T044B	20	6.74
Angled Bracket Spacer					
		–	0T045B	10	15.56
Outlets and Stopends					
Running Outlet					
	♥	100	4T806B	10	26.79
	♥	100	4T806W	10	26.79
	♥	100	4T806N	10	26.79
Stopend Outlet					
	♥	100	4T807B	10	28.41
	♥	100	4T807W	10	28.41
	♥	100	4T807N	10	28.41
Stopend – internal					
	♥	100	4T810B	5	10.28
	♥	100	4T810W	5	10.28
	♥	100	4T810N	5	10.28
Stopend – external					
	♥	100	4T811B	10	11.87
	♥	100	4T811W	10	11.87
	♥	100	4T811N	10	11.87
Gutter Angles					
Angle – 90°					
	♥	100	4T803B	10	25.98
	♥	100	4T803W	10	25.98
	♥	100	4T803N	10	25.98

Description		Nom dia mm	Cat no	Pack qty	Price £ per piece
	Angle – 45°	100	4T804B	5	36.08
	▽	100	4T804W	5	36.08
	▽	100	4T804N	5	36.08
	Fabricated angles to order	100	4T999B	1	135.35
		100	4T999W	1	135.35
Connectors to Metal and PVC-U Gutter					
	Connector to 4.5" RoundLine Gutter	100	4T818B	5	43.59
	▽	100	4T818W	5	43.59
	▽				
Rise and Fall Brackets and Spikes					
	Bow and Pin – for Rise and Fall Brackets (for use with Build-in or in Spikes)	100	4T894B	10	28.93
		Build-in Spike – 200mm long	–	0T985B	10
	Build-in Spike – 300mm long	–	0T986B	10	25.14
	Drive-in Spike – 200mm long	–	0T988B	10	13.96
	Drive-in Spike – 300mm long	–	0T989B	10	18.74
Rafter Brackets (BZP)					
	Adjustable Top Rafter Bracket – 300mm long	–	0T147G	20	36.02
		Adjustable Side Rafter Bracket – 300mm long	–	0T148G	20

Wavin Osma SquareLine







Rainwater square – PVC-U

Description		Nom dia mm	Cat no	Pack qty	Price £ per piece
Pipe					
	P/E Pipe – 2.0m				
	▽	61	4T882B	5	43.53
	▽	61	4T882W	5	43.53
	▽	61	4T882N	5	43.53
P/E Pipe – 2.75m					
	▽	61	4T886B	5	61.51
	▽	61	4T886W	5	61.51
	▽	61	4T886N	5	61.51
P/E Pipe – 4.0m					
	▽	61	4T884B	5	89.16
	▽	61	4T884W	5	89.16
	▽	61	4T884N	5	89.16
P/E Pipe – 5.5m					
	▽	61	4T888B	5	122.66
	▽	61	4T888W	5	122.66
	▽	61	4T888N	5	122.66
Pipe Brackets and Spacer					
Pipe Bracket – Stand Off					
	▽	61	4T833B	5	9.19
	▽	61	4T833W	5	9.19
	▽	61	4T833N	5	9.19
Pipe Bracket					
	▽	61	4T834B	5	7.82
	▽	61	4T834W	5	7.82
	▽	61	4T834N	5	7.82
Pipe Bracket Spacer					
	– for use with 4T834, 4T823,	–	4T731B	10	13.00
	4T832, 4T858, 4T855	–	4T731W	10	13.00
Connectors and Adaptors					
Pipe Connector and Bracket – Stand Off					
	▽	61	4T824B	5	27.00
	▽	61	4T824W	5	27.00
	▽	61	4T824N	5	27.00
Pipe Connector and Bracket					
	▽	61	4T823B	5	24.44
	▽	61	4T823W	5	24.44
	▽	61	4T823N	5	24.44
Drain Adaptor – Square to Round					
	▽	61	4T836B	10	22.15
	▽	61	4T836W	5	22.15
Outlet Adaptor – Square to Round					
	▽	61	4T837B	5	27.63
	▽	61	4T837W	5	27.63
Rainwater Adaptor 68mm pipe to 110mm PVC-U drain					
		–	4S149	10	24.05
Rainwater Adaptor 68mm pipe to 110mm PVC-U drain					
	▽	–	0T149B	5	30.22

	Description	Nom dia mm	Cat no	Pack qty	Price £ per piece
	Universal Drain Adaptor	–	4S159	10	25.63
Bends, Shoe and Wall Offsets					
	Offset Bend – socket				
	▽	61	4T825B	20	15.48
	▽	61	4T825W	20	15.48
	▽	61	4T825N	20	15.48
	Offset Bend – spigot				
	▽	61	4T826B	10	19.21
	▽	61	4T826W	10	19.21
	▽	61	4T826N	10	19.21
	Pipe Bend – 87.5°				
	▽	61	4T862B	5	33.04
	▽	61	4T862W	5	33.04
	▽	61	4T862N	5	33.04
	Pipe Shoe and Bracket				
	▽	61	4T832B	5	22.93
	▽	61	4T832W	5	22.93
	▽	61	4T832N	5	22.93
	Pipe Wall Offset				
	▽	61	4T838B	10	31.07
	▽	61	4T838W	10	31.07
	▽	61	4T838N	10	31.07
	Pipe Wall Offset – with access	61	4T858B	5	87.12
Branch, Access Pipe and Hopper Head					
	Pipe Branch – 67.5°				
	▽	61	4T835B	5	63.46
	▽	61	4T835W	5	63.46
	▽	61	4T835N	5	63.46
	Access Pipe	61	4T855B	5	87.12
	Hopper Head				
		61	4T830B	5	80.06
		61	4T830W	5	80.06
		61	4T830N	5	80.06
Rainwater Diverter Kit					
	Rainwater Diverter Kit				
		61	OT201B	1	99.40
		61	OT201W	1	99.40















Wavin Osma SquareLine

Rainwater square – PVC-U

Description	Nom dia mm	Cat no	Pack qty	Price £ per piece
Spares				
 Gutter Seal	100	4T864B	5	4.05
 Flexiclip	100	4T816B	1	3.77
 ▼	100	4T816W	1	3.77
 ▼	100	4T816N	1	3.77
 Gutter Pad – narrow	100	4T860G	10	4.23
 Gutter Pad – wide	100	4T861G	10	4.13









Wavin Osma StormLine

Rainwater ogee – PVC-U

	Description	Nom dia mm	Cat no	Pack qty	Price £ per piece
	Gutter				
	Gutter – 4.0m	111	8T874B	4	110.85
		111	8T874W	4	110.85
Gutter Unions and Brackets					
	Gutter Jointing Bracket				
	▽	111	8T809B	10	23.72
	▽	111	8T809W	10	23.72
	Gutter Support Bracket				
	▽	111	8T819B	10	8.80
	▽	111	8T819W	10	8.80
	Gutter Hanging Bracket				
	▽	111	8T849B	20	11.71
	▽	111	8T849W	20	11.71
	Gutter Bracket Spacer – 21mm projection	–	0T044B	20	6.74
Outlets and Stopends					
	Running Outlet				
	▽	111	8T806B	5	31.65
	▽	111	8T806W	5	31.65
	Stopend Outlet (left hand)				
	▽	111	8T807B	5	29.33
	▽	111	8T807W	5	29.33
	Stopend Outlet (right hand)				
	▽	111	8T808B	5	29.33
	▽	111	8T808W	5	29.33
	Stopend – internal (left hand)				
	▽	111	8T840B	5	13.33
	▽	111	8T840W	5	13.33
	Stopend – internal (right hand)				
	▽	111	8T850B	5	13.33
	▽	111	8T850W	5	13.33
	Stopend – external (left hand)				
	▽	111	8T841B	10	18.65
	▽	111	8T841W	10	18.65
	Stopend – external (right hand)				
	▽	111	8T851B	10	18.65
	▽	111	8T851W	10	18.65
Gutter Angles					
	Angle – 90° (internal)				
	▽	111	8T843B	5	34.90
	▽	111	8T843W	5	34.90
	Angle – 90° (external)				
	▽	111	8T853B	5	31.06
	▽	111	8T853W	5	31.06

Wavin Osma StormLine









Rainwater ogee – PVC-U

Description	Nom dia mm	Cat no	Pack qty	Price £ per piece
 Angle – 45° (internal) ♡ ♡	111	8T844B	5	36.71
	111	8T844W	5	36.71
 Angle – 45° (external) ♡ ♡	111	8T854B	5	36.71
	111	8T854W	5	36.71
Fabricated angles to order	–	8T999B	1	150.20
	–	8T999W	1	150.20
Rise and Fall Brackets and Spikes				
 Bow and Pin – For Rise and Fall Brackets (for use with Build-in or Drive-in Spikes)	111	8T894B	10	34.78
	111	8T894W	10	34.78
 Build-in Spike – 200mm long – 300mm long	–	0T985B	10	16.74
	–	0T986B	10	25.14
 Drive-in Spike – 200mm long – 300mm long	–	0T988B	10	13.96
	–	0T989B	10	18.74
Rafter Brackets (BZP)				
 Adjustable Top Rafter Bracket – 300mm long	–	0T147G	20	36.02
 Adjustable Side Rafter Bracket – 300mm long	–	0T148G	20	33.26
Spares				
 Gutter Seal	111	8T864B	1	3.38
 Flexiclip ♡ ♡	111	8T816B	1	3.56
	111	8T816W	1	3.56

Note: For details of 61mm (2¼") and 68mm (2½") pipe and fittings for use with the StormLine Rainwater System refer to pages 12-14 and 6-9.

Wavin Osma DeepLine

Rainwater high capacity – PVC-U









	Description	Nom dia mm	Cat no	Pack qty	Price £ per piece
	Gutter Gutter – 4.0m				
	▽	113	9T974B	5	89.54
	▽	113	9T974G	5	89.54
	▽	113	9T974W	5	89.54
	▽	113	9T974N	5	89.54
	▽	113	9T974AG	5	89.54
Gutter Union and Brackets					
	Gutter Union				
	▽	113	9T909B	5	19.57
	▽	113	9T909G	5	19.57
	▽	113	9T909W	5	19.57
	▽	113	9T909N	5	19.57
	▽	113	9T909AG	5	19.57
	Gutter Support Bracket				
	▽	113	9T919B	40	6.82
	▽	113	9T919G	20	6.82
	▽	113	9T919W	20	6.82
	▽	113	9T919N	20	6.82
	▽	113	9T919AG	20	6.82
	Gutter Bracket Spacer – 21mm projection	–	OT044B	20	6.74
		–	OT045B	10	15.56
Outlet and Stopends					
	Running Outlet				
	▽	113	9T906B	5	24.04
	▽	113	9T906G	5	24.04
	▽	113	9T906W	5	24.04
	▽	113	9T906N	5	24.04
	▽	113	9T906AG	5	24.04
	Stopend – internal				
	▽	113	9T910B	5	8.54
	▽	113	9T910G	5	8.54
	▽	113	9T910W	5	8.54
	▽	113	9T910N	5	8.54
	▽	113	9T910AG	5	8.54
	Stopend – external				
	▽	113	9T911B	5	12.03
	▽	113	9T911G	5	12.03
	▽	113	9T911W	5	12.03
	▽	113	9T911N	5	12.03
	▽	113	9T911AG	5	12.03

Note:

For details of 68mm (2½") pipe and fittings for use with DeepLine profile refer to pages 6-9.













Wavin Osma DeepLine

Rainwater high capacity – PVC-U

Description	Nom dia mm	Cat no	Pack qty	Price £ per piece
Gutter Angles				
 Angle – 90°	113	9T903B	5	31.10
	113	9T903G	5	31.10
	113	9T903W	5	31.10
	113	9T903N	5	31.10
	113	9T903AG	5	31.10
 Angle – 45°	113	9T904B	5	35.64
	113	9T904G	5	35.64
	113	9T904W	5	35.64
	113	9T904N	5	35.64
	113	9T904AG	5	35.64
Fabricated angles to order	113	9T999B	1	137.04
	113	9T999G	1	137.04
	113	9T999W	1	137.04
Rise and Fall Brackets and Spikes				
 Bow and Pin – for Rise and Fall Brackets (for use with Build-in or Drive-in Spikes)	113	9T994B	10	31.68
	113	9T994G	10	31.68
	113	9T994AG	10	31.68
 Build-in Spike – 200mm long – 300mm long	–	0T985B	10	16.74
	–	0T986B	10	25.14
 Drive-in Spike – 200mm long – 300mm long	–	0T988B	10	13.96
	–	0T989B	10	18.74
Rafter Brackets (BZP)				
 Adjustable Top Rafter Bracket – 300mm long	–	0T147G	20	36.02
 Adjustable Side Rafter Bracket – 300mm long	–	0T148G	20	33.26
Spares				
 Gutter Seal	113	9T964B	10	3.23
 Flexiclip	113	9T916B	1	3.29
	113	9T916G	1	3.29
	113	9T916W	1	3.29
	113	9T916N	1	3.29
	113	9T916AG	1	3.29







Wavin Osma SuperLine

Rainwater half round commercial – PVC-U

	Description	Nom dia mm	Cat no	Pack qty	Price £ per piece
	Gutter Gutter – 4.0m ▽	125	5T574B	5	118.03
	Gutter Union and Brackets Gutter Union ▽	125	5T509B	5	23.54
	Gutter Support Bracket ▽	125	5T519B	5	8.59
	Gutter Bracket Spacer – 21mm projection	–	0T044B	20	6.74
	Angled Bracket Spacer	–	0T045B	10	15.56
	Outlet and Stopends Running Outlet ▽	125	5T508B	5	35.15
	Stopend – internal ▽	125	5T510B	5	11.43
	Stopend – external ▽	125	5T511B	5	17.24
	Gutter Angles Angle – 90° ▽	125	5T503B	5	39.34
	Angle – 45° ▽	125	5T504B	5	44.83
	Fabricated angles to order	125	5T999B	1	157.54
	Rise and Fall Brackets and Spikes Bow and Pin – for Rise and Fall Brackets (for use with Build-in or Drive-in-Spikes)	125	5T594B	5	37.85
	Build-in Spike – 200mm long	–	0T985B	10	16.74
	– 300mm long	–	0T986B	10	25.14
	Drive-in Spike – 200mm long	–	0T988B	10	13.96
	– 300mm long	–	0T989B	10	18.74

Wavin Osma SuperLine













Rainwater half round commercial – PVC-U

Description	Nom dia mm	Cat no	Pack qty	Price £ per piece
 Rafter Brackets (PVC Coated Steel) Top Rafter Bracket – 300mm long	125	5T595B	10	40.83
 Side Rafter Bracket – 300mm long	125	5T596B	10	43.20
 Rafter Bracket (BZP) Adjustable Top Rafter Bracket – 300mm long	–	0T147G	20	36.02
 Adjustable Side Rafter Bracket – 300mm long	–	0T148G	20	33.26
 Rainwater Hopper Hopper Head	110	4S326B	5	140.23
 Spares Gutter Seal	125	5T564B	10	4.58
 Flexiclip ♡	125	5T516B	1	4.04

Note: For details of 68mm (2½") pipe and fittings for use with the SuperLine Rainwater System refer to pages 6-9.







Wavin Osma RoofLine

Rainwater half round commercial – PVC-U

Description		Nom dia mm	Cat no	Pack qty	Price £ per piece
	Gutter Gutter – 4.0m	150	6T674B	5	238.01
	♥ ♥	150	6T674G	5	238.01
Gutter Union and Bracket					
	Gutter Union	150	6T609B	5	63.26
	♥ ♥	150	6T609G	5	63.26
	Gutter Support Bracket	150	6T619B	10	22.15
	♥ ♥	150	6T619G	10	22.15
	Gutter Bracket Spacer – 21mm projection	–	0T044B	20	6.74
Outlet and Stopends					
	Running Outlet	150	6T606B	5	86.88
	♥ ♥	150	6T606G	5	86.88
	Stopend – internal	150	6T610B	5	14.89
	♥ ♥	150	6T610G	5	14.89
	Stopend – external	150	6T611B	5	43.10
	♥ ♥	150	6T611G	5	43.10
Gutter Angles					
	Angle – 90°	150	6T603B	5	122.02
	♥ ♥	150	6T603G	5	122.02
	Fabricated angles to order	150	6T999B	1	218.69
		150	6T999G	1	231.31
Rise and Fall Brackets and Spikes					
	Bow and Pin – for Rise and Fall Brackets (for use with Build-in or Drive-in Spikes)	150	6T694B	20	47.98
		150	6T694G	20	47.98
	Build-in Spike – 200mm long	–	0T985B	10	16.74
	– 300mm long	–	0T986B	10	25.14
	Drive-in Spike – 200mm long	–	0T988B	10	13.96
	– 300mm long	–	0T989B	10	18.74
Rafter Brackets (PVC coated steel)					
	Top Rafter Bracket – 300mm long	150	6T695B	10	44.79

Wavin Osma RoofLine









Rainwater half round commercial – PVC-U

Description	Nom dia mm	Cat no	Pack qty	Price £ per piece
 Side Rafter Bracket – 300mm long	150	6T696B	10	47.39
Rafter Brackets (BZP)				
 Adjustable Top Rafter Bracket – 300mm long	–	0T147G	20	36.02
 Adjustable Side Rafter Bracket – 300mm long	–	0T148G	20	33.26
Rainwater Hopper				
 Hopper Head	110	4S326B	5	140.23
	110	4S326G	5	140.23
Spares				
 Gutter Seal	150	6T664B	4	4.92
 Flexiclip	150	6T616B	1	4.52
	150	6T616G	1	4.52

Note: For details of 110mm (4") pipe and fittings for use with the RoofLine Rainwater System refer to pages 23-36.

Wavin OsmaSoil









Soil and Vent PVC-U Ring-seal system

Description		Nom dia mm	Cat no	Pack qty	Price £ per piece
	S/S Pipe – 2.0m	110	4S042B	2	100.42
	▽△ ▽△	110	4S042G	2	100.42
 Made with Wavin Recycore Technology™	S/S Pipe – 2.5m	110	4S050G	50	119.07
	▽△				
 50% RECYCLED RAW MATERIAL	S/S Pipe – 3.0m	82	3S043B	2	152.09
	▽	82	3S043G	2	152.09
	▽△	110	4S043B	2	132.02
	▽△	110	4S043G	2	132.02
	▽△	110	4S043W	2	132.02
	▽△	160	6S043G	2	491.72
	S/S Pipe – 4.0m	110	4S044B	2	178.11
	▽△	110	4S044G	2	178.11
	▽△	110	4S044W	2	178.11
	▽△	160	6S044G	2	639.81
	P/E Pipe – 3.0m	110	4S073B	2	127.01
	▽△	110	4S073G	2	127.01
	▽△	110	4S073W	2	127.01
 Made with Wavin Recycore Technology™ 50% RECYCLED RAW MATERIAL	P/E Pipe – 4.0m	82	3S074G	2	198.38
	▽	110	4S074B	2	169.32
	▽△	110	4S074G	2	169.32
	▽△	110	4S074W	2	169.32
	▽△	160	6S074B	2	592.37
	▽△	160	6S074G	2	592.37
Brackets					
	Pipe Bracket	82	3S082B	5	13.67
	▽	82	3S082G	5	13.67
	▽	110	4S082B	10	11.69
	▽	110	4S082G	10	11.69
	▽	110	4S082W	10	11.69
	▽	160	6S082B	1	42.86
	▽	160	6S082G	1	42.86
	Socket Bracket	82	3S083B	5	18.18
	▽	82	3S083G	5	18.18
	▽	110	4S083B	5	15.58
	▽	110	4S083G	5	15.58
	▽	110	4S083W	5	15.58
	Pipe or Socket Bracket – BZP coated steel	110	4S084	10	33.75
	▽	160	6S084	1	71.20

Note: △ Recycore Technology applies to 110mm and 160mm sizes only.

Wavin OsmaSoil











Soil and Vent PVC-U Ring-seal system









Description		Nom dia mm	Cat no	Pack qty	Price £ per piece
Suspended Bracketing System					
(Not suitable for damp inaccessible voids)					
	Adjustable Pipe Bracket Assembly (pack containing threaded rod, threaded bracket, bracket plate and pipe/socket bracket) – BZP coated steel	110	4S086	1	109.66
	Adjustable Socket Bracket and Brace Assembly (pack containing threaded rod, threaded bracket, bracket plate, two adjustable braces and pipe/socket bracket) – BZP coated steel	110	4S085	1	225.70
Sockets					
D/SW Double Socket					
	♥	110	4S104B	5	25.69
	♥	110	4S104G	5	25.69
	♥	110	4S104W	5	25.69
	♥	160	6S104B	1	62.25
	♥	160	6S104G	1	62.25
D/S Double Socket – for repairs					
	♥	82	3S105B	5	51.39
	♥	82	3S105G	5	51.39
	♥	110	4S105B	5	55.48
	♥	110	4S105G	5	55.48
	♥	110	4S105W	5	55.48
	♥	160	6S105G	1	156.31
S/SW Single Socket					
	♥	82	3S124B	5	29.96
	♥	82	3S124G	5	29.96
	♥	110	4S124B	5	26.75
	♥	110	4S124G	5	26.75
	♥	110	4S124W	5	26.75
	♥	160	6S124B	1	91.57
	♥	160	6S124G	1	91.57
D/S Acoustic Socket					
	♥	110	4S125B	5	40.64
	♥	110	4S125G	5	40.64
D/S Double Sockets					
		110	4S205B	10	47.81
		110	4S205G	10	47.81
		110	4S205W	10	47.81
Connectors					
S/S Connector to CI soil socket					
	♥	110	4S106G	5	75.61

Description		Nom dia mm	Cat no	Pack qty	Price £ per piece
	Connector to CI soil socket – synthetic rubber	110	4S206B	5	82.17
	Internal Drain Connector for 32mm/40mm waste pipe	110	4S298	5	27.16
	Internal Drain Connector – for 50mm waste pipe	110	4S299	5	31.26
Reducers					
	S/S Reducer – 82mm x 50mm	82	3S094B	5	62.78
	♥	82	3S094G	5	62.78
	Reducer – 110mm x 32mm waste	110	4S098G	5	62.23
	– 110mm x 40mm waste	110	4S097G	5	62.23
	S/S Reducer – 110mm x 50mm	110	4S096B	5	59.07
	♥	110	4S096G	5	59.07
	S/S Reducer – 110mm x 82mm	110	4S095B	5	54.18
	♥	110	4S095G	5	54.18
	S/S Reducer – 160mm x 110mm	160	6S099G	1	138.70
Bends					
	S/S Bend – 87.5°	82	3S161B	5	60.83
	♥	82	3S161G	5	60.83
	♥	110	4S161B	5	70.84
	♥	110	4S161G	5	70.84
	♥	110	4S161W	5	70.84
	♥	160	6S161G	1	239.89
	S/SW Bend – 87.5°	110	4S361G	5	69.74
	S/S Tight Radius Bend – 87.5°	110	4S160B	10	78.69
	♥	110	4S160G	10	78.69
	♥	110	4S160W	10	78.69

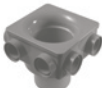
Wavin OsmaSoil











Soil and Vent PVC-U Ring-seal system











Description		Nom dia mm	Cat no	Pack qty	Price £ per piece
	D/S Bend – 87.5°	110	4S561B	5	88.36
		110	4S561G	5	88.36
		110	4S561W	5	88.36
	S/S Bend – 76°	110	4S164B	5	100.89
		110	4S164G	5	100.89
	S/S Bend – 67.5°	110	4S162G	5	101.68
	S/S Bend – 45°	82	3S163B	5	60.83
		82	3S163G	5	60.83
		110	4S163B	5	70.84
		110	4S163G	5	70.84
		110	4S163W	5	70.84
		160	6S163G	1	239.89
	S/SW Bend – 45°	110	4S363B	5	69.74
		110	4S363G	5	69.74
		110	4S363W	5	69.74
	S/S Bend – 30°	110	4S166G	5	78.44
	S/S Bend – 15°	110	4S167G	5	90.27
Adjustable Bends					
	S/S Adjustable Bend – 30°	110	4S173G	1	89.00
	S/S Adjustable Bend – 90°	110	4S179G	1	100.63
Offset Bends					
	SW/S Offset Bend (bottom)	82	3S435G	5	63.39
		110	4S435B	5	66.11
		110	4S435G	5	66.11
		110	4S435W	5	66.11

Description		Nom dia mm	Cat no	Pack qty	Price £ per piece
	S/SW Offset Bend (top)	82	3S440B	5	74.79
	♥	82	3S440G	5	74.79
	♥	110	4S440B	5	90.69
	♥	110	4S440G	5	90.69
	♥	110	4S440W	5	90.69
	♥	160	6S440G	1	268.08
	S/S Offset Bend	110	4S444B	5	90.69
	♥	110	4S444G	5	90.69
	♥	110	4S444W	5	90.69
	D/S Offset Bend	110	4S445B	5	100.89
	♥	110	4S445G	5	100.89
	♥	110	4S445W	5	100.89
Manifolds					
	6 Boss Manifold	110	4S597G	1	111.40
	OsmaLink Soil Manifold	110	4S595G	1	122.48
	All-Fit Reducer – 1½" / 40 x 1¼" / 32	40	4Z124W	10	11.10
	All-Fit Reduction Bend – 2" / 50 x 1½" / 40	50	2S355W	10	16.27
	All-Fit 90° Spigot Bend – 2" / 50	50	2S356W	5	26.78
Branches					
	S/S Single Branch – 87.5°	82	3S190B	5	108.28
	♥	82	3S190G	5	108.28
	♥	110	4S190B	5	99.99
	♥	110	4S190G	5	99.99
	♥	110	4S190W	5	99.99
	♥	160	6S190G	1	433.25
	S/S Single 5 Boss Branch – 87.5°	110	4S195B	5	129.61
	♥	110	4S195G	5	129.61
	♥	110	4S195W	5	129.61

Wavin OsmaSoil









Soil and Vent PVC-U Ring-seal system







	Description	Nom dia mm	Cat no	Pack qty	Price £ per piece
	S/SW Single 5 Boss Branch – 87.5° ♥	110	4S395G	5	112.41
	S/S Unequal Single Branch – 87.5° ♥	160	6S198G	1	333.91
	S/S Single Branch – 76° ♥	110	4S220B	1	145.04
	♥	110	4S220G	1	145.04
	S/S Single Branch – 67.5° ♥	110	4S200B	1	145.04
	♥	110	4S200G	1	145.04
	S/S Single Branch – 45° ♥	82	3S210G	5	108.28
	♥	110	4S210B	5	148.64
	♥	110	4S210G	5	148.64
	160x110mm ♥	160	6S218G	1	333.91
	160x160mm ♥	160	6S210G	1	433.25
	S/S Double Branch – 87.5° ♥	110	4S230B	1	250.05
	♥	110	4S230G	1	250.05
	♥	110	4S230W	1	250.05
	S/S Unequal Double Branch – 87.5° ♥	160	6S238G	1	590.08
	S/S Double Branch – 45° ♥	110	4S250G	1	311.72
	S/S Corner Branch – 87.5° ♥	110	4S291G	1	393.62
Boss Socket Adaptors					
	S/S Boss Adaptor (Ring-Seal) – for 1¼" / 32 plastic or copper pipe ♥	32	2S398B	10	13.99
	♥	32	2S398G	10	13.99
	♥	32	2S398W	5	13.99

Description		Nom dia mm	Cat no	Pack qty	Price £ per piece
	S/S Boss Adaptor (Ring-Seal) – for 1½" / 40 plastic or copper pipe	40	2S399B	5	13.99
	▽	40	2S399G	10	13.99
	▽	40	2S399W	10	13.99
	S/S Boss Adaptor (Ring-Seal) – 2" / 50 plastic or copper pipe	50	2S402B	5	18.04
	▽	50	2S402G	5	18.04
	▽	50	2S402W	5	18.04
	S/S Boss Adaptor 90° (Ring-Seal) – for 2" / 50 BS EN 1329, 1455 and 1566 pipe	50	2S360G	10	19.85
	▽				
Bossed Pipes					
	S/S Bossed Pipe – plain with one boss socket	82	3S649B	10	58.07
	▽	82	3S649G	10	58.07
	S/S Bossed Pipe – for 1¼" / 32 plastic or copper pipe	110	4S581B	5	75.99
	▽ – NEW	110	4S581G	5	75.99
	S/S Bossed Pipe – for 1½" / 40 plastic or copper pipe	110	4S582B	5	60.87
	▽ – NEW	110	4S582G	5	60.87
	D/SW Bossed Pipe (Ring Seal) – for 1¼" / 32 plastic or copper pipe	110	4S583B	5	29.53
	▽	110	4S583G	5	29.53
	▽	110	4S583W	5	29.53
	D/SW Bossed Pipe (Ring Seal) – for 1½" / 40 plastic or copper pipe	110	4S584B	5	25.66
	▽	110	4S584G	5	25.66
	▽	110	4S584W	5	25.66
	D/SW Short Bossed Pipe	110	4S588B	5	25.46
		110	4S588G	5	25.46
	– NEW	110	4S588W	5	25.46
	S/S Bossed Pipe – plain with four boss sockets	110	4S589B	5	41.41
	▽	110	4S589G	5	41.41
	▽	110	4S589W	5	41.41

Wavin OsmaSoil

Soil and Vent PVC-U Ring-seal system











	Description	Nom dia mm	Cat no	Pack qty	Price £ per piece
	S/SW Bossed Pipe – plain with four boss sockets	110	4S590B	5	49.34
	♥	110	4S590G	5	49.34
Strap Bosses					
	Strap Boss	82	3S319B	5	28.32
	♥	82	3S319G	5	28.32
	♥	110	4S319B	5	23.75
	♥	110	4S319G	5	23.75
	♥	110	4S319W	5	23.75
	Clip Boss For Push-fit or Solvent Waste – 32mm	110	4S322B	10	29.23
		110	4S322G	10	29.23
		110	4S322W	10	29.23
	For Push-fit or Solvent Waste – 40mm	110	4S321B	5	29.23
		110	4S321G	5	29.23
		110	4S321W	5	29.23
	Patch Boss For Push-fit or Solvent Waste – 50mm	160	6S323G	1	57.56
Access Fittings					
	S/S Access Bend – 87.5°	110	4S169B	5	166.66
	♥	110	4S169G	5	166.66
	♥	110	4S169W	5	166.66
	S/SW Access Bend – 87.5°	110	4S369G	5	191.50
	♥				
	S/S Access Branch – 87.5°	110	4S502B	1	225.70
	♥	110	4S502G	1	225.70
	S/S Access Pipe – with bolted door	82	3S274B	5	119.55
	♥	82	3S274G	5	119.55

Description		Nom dia mm	Cat no	Pack qty	Price £ per piece
	S/S Bossed Access Pipe – with screwed access and three boss sockets	110	4S274B	1	119.94
	▽	110	4S274G	5	119.94
	▽	110	4S274W	1	119.94
	▽	160	6S274G	1	324.91
	S/SW Bossed Access Pipe – with screwed access and three boss sockets	110	4S374G	10	121.77
	Access Saddle	110	4S275B	1	65.25
	▽	110	4S275G	1	65.25
Plugs					
	P/E Access Plug	82	3S292B	5	59.18
	▽	82	3S292G	5	59.18
	▽	110	4S292B	1	55.39
	▽	110	4S292G	1	55.39
	▽	110	4S292W	1	55.39
	▽	160	6S292B	1	121.11
	▽	160	6S292G	1	121.11
	P/E Socket Plug – with one boss socket	110	4S296B	5	39.04
	▽	110	4S296G	5	39.04
	▽	110	4S296W	5	39.04
Spares					
	Snap Cap	82	3S116B	1	3.56
		82	3S116G	1	3.56
		110	4S116B	1	11.48
		110	4S116G	1	11.48
		110	4S116W	1	11.48
	T Ring Seal	110	4S130G	5	8.27
		160	6S130G	5	14.68











Note: For OsmaSoil WC Connectors, Terminal Fittings and Ancillary Items see pages 37-40

Wavin OsmaSoil

Soil and Vent PVC-U Solvent Weld system











Description		Nom dia mm	Cat no	Pack qty	Price £ per piece
  	Pipe				
	P/E Pipe – 3.0m				
	▽△	110	4S073B	2	127.01
	▽△	110	4S073G	2	127.01
	▽△	110	4S073W	2	127.01
	P/E Pipe – 4.0m				
	▽△	110	4S074B	2	169.32
	▽△	110	4S074G	2	169.32
	▽△	110	4S074W	2	169.32
	▽△	160	6S074B	2	592.37
▽△	160	6S074G	2	592.37	
  	Brackets				
	Pipe Bracket				
	▽	110	4S082B	10	11.69
	▽	110	4S082G	10	11.69
	▽	110	4S082W	10	11.69
	▽	160	6S082B	1	42.86
	▽	160	6S082G	1	42.86
	Socket Bracket				
	▽	110	4S083B	5	15.58
	▽	110	4S083G	5	15.58
▽	110	4S083W	5	15.58	
Pipe or Socket Bracket – BZP coated steel					
▽	110	4S084	10	33.75	
▽	160	6S084	1	71.20	
 	Suspended Bracketing System				
	(Not suitable for damp inaccessible voids)				
	Adjustable Pipe Bracket Assembly (pack containing threaded rod, threaded bracket, bracket plate and pipe/socket bracket) – BZP coated steel	110	4S086	1	109.66
Adjustable Socket Bracket and Brace Assembly (pack containing threaded rod, threaded bracket, bracket plate, two adjustable braces and pipe/socket bracket) – BZP coated steel	110	4S085	1	225.70	
 	Sockets				
	D/SW Double Socket				
	▽	110	4S104B	5	25.69
	▽	110	4S104G	5	25.69
	▽	110	4S104W	5	25.69
	▽	160	6S104B	1	62.25
	▽	160	6S104G	1	62.25
	D/S Double Socket – for repairs				
	▽	110	4S105B	5	55.48
	▽	110	4S105G	5	55.48
▽	110	4S105W	5	55.48	
▽	160	6S105G	1	156.31	



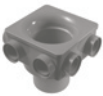





Note: △ Recycore Technology applies to 110mm and 160mm sizes only.

Description		Nom dia mm	Cat no	Pack qty	Price £ per piece
	S/SW Single Socket	110	4S124B	5	26.75
	▽	110	4S124G	5	26.75
	▽	110	4S124W	5	26.75
	▽	160	6S124B	1	91.57
	▽	160	6S124G	1	91.57
	D/S Acoustic Socket	110	4S125B	5	40.64
	▽	110	4S125G	5	40.64
Connectors					
	Connector to CI soil socket – synthetic rubber	110	4S206B	5	82.17
Reducers					
	SW/S Reducer – 110mm x 50mm	110	4S496B	5	53.29
	▽	110	4S496G	5	53.29
	S/S Reducer – 110mm x 82mm	110	4S095B	5	54.18
	▽	110	4S095G	5	54.18
	SW/S Reducer – 160mm x 110mm	160	6S499B	1	100.47
	▽	160	6S499G	1	100.47
Expansion Cap					
	– with integral ring-seal	110	4S416B	5	12.73
		110	4S416G	5	12.73
Bends					
	D/SW Bend – 87.5°	110	4S461B	5	69.65
	▽	110	4S461G	5	69.65
	▽	110	4S461W	5	69.65
	▽	160	6S461B	1	183.50
	▽	160	6S461G	5	183.50
	D/SW Bend – 67.5°	110	4S462B	5	75.36
	▽	110	4S462G	5	75.36
	D/SW Bend – 45°	110	4S463B	5	69.58
	▽	110	4S463G	5	69.58
	▽	160	6S463B	1	187.94
	▽	160	6S463G	5	187.94
	SW/S Bend – 45°	110	4S263B	5	75.36
	▽	110	4S263G	5	75.36

Wavin OsmaSoil











Soil and Vent PVC-U Solvent Weld system

Description		Nom dia mm	Cat no	Pack qty	Price £ per piece
	SW/S Bend – 11.25°	110	4S268B	5	72.71
	▽	110	4S268G	5	72.71
	SW/S Long Tail Bend – 87.5°	110	4S260B	5	80.04
	▽	110	4S260G	5	80.04
Offset Bends					
	SW/S Offset Bend (bottom)	110	4S435B	5	66.11
	▽	110	4S435G	5	66.11
	▽	110	4S435W	5	66.11
	D/SW Offset Bend (top)	110	4S450B	5	73.77
	▽	110	4S450G	1	73.77
Manifold					
	6 Boss Manifold	110	4S597G	1	111.40
Branches					
	D/SW Single Branch – 87.5°	110	4S490B	5	98.47
	▽	110	4S490G	5	98.47
	▽	160	6S490B	1	313.31
	▽	160	6S490G	5	313.31
	SW/S Single Branch – 87.5°	110	4S290B	5	98.53
	▽	110	4S290G	5	98.53
	D/SW Single 5 Boss Branch – 87.5°	110	4S495B	5	102.49
	▽	110	4S495G	5	102.49
	D/SW Unequal Single Branch – 87.5°	160	6S498B	1	241.71
	▽	160	6S498G	5	241.71
	D/SW Single Branch – 45°	110	4S410B	5	111.31
	▽	110	4S410G	5	111.31
	D/SW Double Branch – 87.5°	110	4S430B	1	246.49
	▽	110	4S430G	5	246.49

	Description	Nom dia mm	Cat no	Pack qty	Price £ per piece
	SW/S Corner Branch – 87.5°	110	4S491B	1	436.24
	▽	110	4S491G	5	436.24
Boss Socket Adaptors					
	SW/S Boss Adaptor (Solvent Weld)				
	– for 1 1/4" / 32mm BS EN 1329, 1455 and 1566 pipe	32	2S298B	10	13.01
	▽	32	2S298G	10	13.01
	▽	32	2S298W	10	13.01
	SW/S Boss Adaptor (Solvent Weld)				
	– 1 1/2" / 40mm BS EN 1329, 1455 and 1566 pipe	40	2S299B	10	12.01
	▽	40	2S299G	10	12.01
	▽	40	2S299W	10	12.01
	SW/S Boss Adaptor (Solvent Weld)				
	– for 2" / 50mm BS EN 1329, 1455 and 1566 pipe	50	2S403B	5	14.33
	▽	50	2S403G	5	14.33
	▽	50	2S403W	5	14.33
Bossed Pipes					
	D/SW Bossed Pipe (Solvent Weld)				
	– for 1 1/4" / 32mm BS EN 1329, 1455 and 1566 pipe	110	4S483B	5	30.59
	▽	110	4S483G	5	30.59
	D/SW Bossed Pipe (Solvent Weld)				
	– 1 1/2" / 40mm BS EN 1329, 1455 and 1566 pipe	110	4S484B	5	30.59
	▽	110	4S484G	5	30.59
	D/SW Bossed Pipe				
	– plain (four boss sockets)	110	4S586B	5	34.06
	▽	110	4S586G	5	34.06
	SW/S Bossed Pipe				
	– plain (four boss sockets)	110	4S585B	5	34.06
	▽	110	4S585G	5	34.06
	D/SW Short Bossed Pipe	110	4S588B	5	25.46
		110	4S588G	5	25.46
		110	4S588W	5	25.46

















Wavin OsmaSoil

Soil and Vent PVC-U Solvent Weld system

Description		Nom dia mm	Cat no	Pack qty	Price £ per piece
	S/SW Bossed Pipe – plain (four boss sockets)				
	▽	110	4S590B	5	49.34
	▽	110	4S590G	5	49.34
Strap Boss					
	▽	110	4S319B	5	23.75
	▽	110	4S319G	5	23.75
	▽	110	4S319W	5	23.75
Access Fittings					
	D/SW Access Bend – 87.5°				
	▽	110	4S469B	5	175.57
	▽	110	4S469G	5	175.57
	D/SW Access Branch – 87.5°				
	▽	110	4S493B	1	186.88
	SW/S Bossed Access Pipe – with screwed access and three boss sockets				
	▽	110	4S574B	5	116.74
	▽	110	4S574G	1	116.74
	▽	160	6S474B	1	264.66
	▽	160	6S474G	1	264.66
	D/SW Bossed Access Pipe – with screwed access and three boss sockets				
	▽	110	4S474B	5	116.74
	▽	110	4S474G	5	116.74
	Access Saddle				
	▽	110	4S275B	1	65.25
	▽	110	4S275G	1	65.25
Plugs					
	P/E Access Plug				
	▽	82	3S292B	5	59.18
	▽	82	3S292G	5	59.18
	▽	110	4S292B	1	55.39
	▽	110	4S292G	1	55.39
	▽	110	4S292W	1	55.39
	▽	160	6S292B	1	121.11
	▽	160	6S292G	1	121.11
	SW/S Access Plug				
	▽	110	4S492B	5	69.76
	▽	110	4S492G	1	69.76
	P/E Socket Plug – with one boss socket				
	▽	110	4S296B	5	39.04
	▽	110	4S296G	5	39.04
	▽	110	4S296W	5	39.04



Wavin OsmaSoil

WC connectors

	Description	Nom dia mm	Cat no	Pack qty	Price £ per piece
WC Manifold Branches (for WC to BS 5503)					
	S/SW Manifold Branch – Straight ▽	110	4S601W	1	352.98
	S/SW Manifold Branch – 8° (LH) ▽	110	4S602W	1	352.98
	(RH) ▽	110	4S612W	1	352.98
	S/SW Manifold Branch – 15.5° (LH) ▽	110	4S603W	1	352.98
	(RH) ▽	110	4S613W	1	352.98
	S/SW Manifold Branch – 23° (LH) ▽	110	4S604W	1	352.98
	(RH) ▽	110	4S614W	1	352.98
	S/SW Manifold Branch – 30.5° (LH) ▽	110	4S605W	1	352.98
	(RH) ▽	110	4S615W	1	352.98
	S/SW Manifold Branch – 38° (LH) ▽	110	4S606W	1	352.98
	(RH) ▽	110	4S616W	1	352.98
WC Connectors (for WCs to BS 5503)					
	P/E WC Connector – 2.5° ▽	110	4S791W	10	53.63
	P/E WC Connector – 14° ▽	110	4S711W	5	63.59
	P/E WC Connector – 90° ▽	110	4S771W	10	90.99
	SW/S WC Connector – 90° ▽	110	4S772W	10	78.96
WC Gaskets					
	WC Gasket – for WC spigots from 4" to 4¼"	110	4S121W	10	32.63
	WC Gasket – for WC spigots from 4¼" to 4½"	110	4S120W	10	30.59



Wavin OsmaSoil

WC connectors

Description	Nom dia mm	Cat no	Pack qty	Price £ per piece
 WC Connectors – Ancillary Products S/S Long Tail Bend – 87.5° ♻️	110	4S790W	5	90.69
 P/E Pipe – 600mm length ♻️ ♻️	110	4S600W	1	57.00











Made with Wavin Recycore Technology™

WC connectors – Easy-fit

Description	Nom dia inch	Cat no	Pack qty	Price £ per piece
 Easy-Fit Pan Connectors	4in	WC004W	1	28.61
 Style 1 – Offset	4in	WC204W	1	34.91
 Style 90°	4in	WC904W	1	40.78
 Straight Extension Piece	4in	WC404W	1	34.97

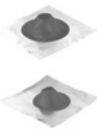
Wavin OsmaSoil

Ancillaries

Description		Nom dia mm	Cat no	Pack qty	Price £ per piece
Terminal Fittings					
	Balloon Grating	82	3S302B	5	21.54
		82	3S302G	5	21.54
		110	4S302B	5	16.40
		110	4S302G	5	16.40
		110	4S302W	5	16.40
		160	6S302G	1	61.51
	Weathering Collar	82	3S300B	5	24.58
		82	3S300G	5	26.01
		110	4S300B	5	22.92
		110	4S300G	5	22.92
		110	4S300W	5	22.92
	SW/S Vent Cowl				
	▽	110	4S310B	1	82.82
	▽	110	4S310G	1	82.82
	Flexible Vent Pipe				
	– connects to ridge tile adaptor. Length 500mm				
		110	4S308B	1	200.24
Air Admittance Valves					
	OsmaVent 40 Air Admittance Valve				
	– fits 1¼" / 32mm and 1½" / 40mm pipe	40	4S303W	1	124.10
	OsmaVent Air Admittance Valve				
	– can also be adapted to fit 82mm soil	110	4S304W	1	280.47
	Domestic Air Admittance Valve All				
		110	4S306G	1	182.13
Pipe Flashings					
	VariPitch Pipe Flashing				
	– 400mm x 400mm – for flat roofs		4S281G	1	223.07
	– 450mm x 450mm – for pitched roofs		4S283G	1	214.86
Roof Outlets					
	SW/S Domed Roof Outlet	82	3S414G	1	208.41
		110	4S414G	1	231.21
Rainwater Hopper and Shoe					
	Hopper Head	82	3S530B	1	166.67
		110	4S326B	5	140.23
		110	4S326G	5	140.23
	S/S Rainwater Pipe Shoe	82	3S288B	5	79.61
		110	4S288B	1	118.82
		110	4S288G	1	118.82







Wavin OsmaSoil

Ancillaries

	Description	Nom dia mm	Cat no	Pack qty	Price £ per piece
	Cleaners, Solvent Cements, Lubricants Degreasing Cleaner No.1 – 250ml can	–	4S380G	10	29.47
	Solvent Cement No. 2 – 125ml can ♡ – 250ml can ♡	–	4S383G	10	34.15
	– 500ml can ♡	–	4S384G	10	45.97
	– 500ml can ♡	–	4S385G	10	100.07
	Solvent Cement Filler – 140ml tube	–	4S394G	5	48.43
	Silicone Lubricant – 50g tube	–	4S391G	5	38.36
	Silicone Lubricant Spray – 400ml can	–	4S392	1	66.79







Wavin OsmaWeld









ABS Solvent Weld waste

Description		Nom dia mm	Cat no	Pack qty	Price £ per piece
Pipe					
	P/E Pipe – 3.0m				
	▽	32	4Z073B	10	27.31
	▽	32	4Z073W	10	27.31
	▽	40	5Z073B	10	33.74
	▽	40	5Z073W	10	33.74
	▽	50	2Z073B	10	43.27
	P/E Pipe – 4.0m				
	▽	32	4Z074G	10	36.41
	▽	40	5Z074G	10	44.91
▽	50	2Z074G	10	57.69	
Bracket					
	Pipe Bracket				
	▽	32	4Z081B	30	1.82
	▽	32	4Z081G	30	1.82
	▽	32	4Z081W	30	1.82
	▽	40	5Z081B	30	1.83
	▽	40	5Z081G	30	1.83
	▽	40	5Z081W	30	1.83
	▽	50	2Z081B	20	3.75
	▽	50	2Z081G	10	3.75
▽	50	2Z081W	10	3.75	
Sockets					
	Double Socket				
	▽	32	4Z104B	20	5.14
	▽	32	4Z104G	10	5.14
	▽	32	4Z104W	20	5.14
	▽	40	5Z104B	30	5.28
	▽	40	5Z104G	30	5.28
	▽	40	5Z104W	30	5.28
	▽	50	2Z104B	10	10.56
	▽	50	2Z104G	5	10.56
▽	50	2Z104W	5	10.56	
	Expansion Socket – with solvent socket tail				
	▽	32	4Z124G	10	11.10
	▽	32	4Z124W	10	11.10
	▽	40	5Z124G	10	10.56
	▽	40	5Z124W	10	10.56
▽	50	2Z124W	5	18.34	
Bends					
	Knuckle Bend – 90°				
	▽	32	4Z160B	10	6.85
	▽	32	4Z160G	10	6.85
	▽	32	4Z160W	10	6.85
	▽	40	5Z160B	20	8.10
	▽	40	5Z160G	20	8.10
	▽	40	5Z160W	20	8.10
	▽	50	2Z160B	10	12.69
	▽	50	2Z160G	5	12.69
▽	50	2Z160W	5	12.69	

Wavin OsmaWeld









ABS Solvent Weld waste

Description		Nom dia mm	Cat no	Pack qty	Price £ per piece
	Spigot Bend – 90°	32	4Z260B	15	9.34
	♥	32	4Z260G	15	9.34
	♥	32	4Z260W	15	9.34
	♥	40	5Z260B	15	9.07
	♥	40	5Z260G	15	9.07
	♥	40	5Z260W	15	9.07
	♥	50	2Z260B	10	11.51
	♥	50	2Z260G	10	11.51
	♥	50	2Z260W	10	11.51
	Bend – 87.5°	32	4Z161B	10	7.20
	♥	32	4Z161G	10	7.20
	♥	32	4Z161W	25	7.20
	♥	40	5Z161B	10	8.60
	♥	40	5Z161G	10	8.60
	♥	40	5Z161W	10	8.60
	♥	50	2Z161B	5	13.44
	♥	50	2Z161G	5	13.44
	♥	50	2Z161W	5	13.44
	Bend – 45°	32	4Z163B	20	6.44
	♥	32	4Z163G	20	6.44
	♥	32	4Z163W	20	6.44
	♥	40	5Z163B	20	7.20
	♥	40	5Z163G	20	7.20
	♥	40	5Z163W	20	7.20
	♥	50	2Z163B	10	13.76
	♥	50	2Z163G	5	13.76
	♥	50	2Z163W	5	13.76
	Bend – 45° – male and female	32	4Z263B	5	5.48
	♥	32	4Z263W	5	5.48
	♥	40	5Z263B	10	6.37
	♥	40	5Z263G	10	6.37
	♥	40	5Z263W	10	6.37
	Long Tail Bend – 87.5°	50	2Z359G	5	21.44
Tees					
	Tee – 87.5°	32	4Z190B	10	8.54
	♥	32	4Z190G	10	8.54
	♥	32	4Z190W	10	8.54
	♥	40	5Z190B	5	9.00
	♥	40	5Z190G	5	9.00
	♥	40	5Z190W	5	9.00
	♥	50	2Z190B	10	18.53
	♥	50	2Z190G	5	18.53
	♥	50	2Z190W	5	18.53

Description		Nom dia mm	Cat no	Pack qty	Price £ per piece
	Tee – 45°	32	4Z210W	10	13.52
	♥	40	5Z210B	5	16.44
	♥	40	5Z210G	5	16.44
	♥	40	5Z210W	5	16.44
	♥	50	2Z210B	5	24.00
	♥	50	2Z210G	5	24.00
	♥	50	2Z210W	5	24.00
	Cross Tee Cross – 87.5°	40	5Z230W	5	28.98
	♥	50	2Z230W	5	43.88
	Plug Access Plug	32	4Z292B	10	7.31
	♥	32	4Z292G	5	7.31
	♥	32	4Z292W	5	7.31
	♥	40	5Z292B	15	7.69
	♥	40	5Z292G	15	7.69
	♥	40	5Z292W	15	7.69
	♥	50	2Z292B	5	13.60
	♥	50	2Z292G	5	13.60
♥	50	2Z292W	5	13.60	
Connectors and Adaptors					
	Straight Adaptor – Push fit to solvent weld	32	4Z120W	10	7.49
	♥	40	5Z120W	10	7.49
	Straight Tank Connector	32	4Z185W	10	17.95
	♥	40	5Z185W	5	18.60
	Universal Connector – for BS EN 1329, 1451, 1455 and 1566 pipe	32	4W102B	10	10.21
	♥	32	4W102G	10	10.21
	♥	32	4W102W	10	10.21
	♥	40	5W102B	5	10.21
	♥	40	5W102G	5	10.21
	♥	40	5W102W	5	10.21
	Male Cap and Liner – male threaded component	32	4Z363W	10	11.07
	♥	40	5Z363W	10	11.07
	Female Cap and Liner – female threaded component	32	4Z364W	5	7.19
	♥	40	5Z364W	5	8.10
	Female Iron Connector – solvent weld socket and BSPT socket	32	4Z127W	5	15.07
	♥	40	5Z127W	10	16.39







Wavin OsmaWeld

ABS Solvent Weld waste

	Description	Nom dia mm	Cat no	Pack qty	Price £ per piece
	Male Iron Connector – SW/S and BSPT spigot				
	▽	32	4Z128W	5	14.25
	▽	40	5Z128W	10	15.07
	▽	50	2Z128W	5	18.78
Reducers					
	Socket Reducer – 2"/50mm x 1¼"/32mm	50	2Z088B	10	9.07
		50	2Z088G	5	9.07
		50	2Z088W	5	9.07
	Socket Reducer – 2"/50mm x 1½"/40mm	50	2Z086B	10	8.86
		50	2Z086G	5	8.86
		50	2Z086W	5	8.86
	Socket Reducer – 1½"/40mm x 1¼"/32mm	40	5Z455B	10	4.84
		40	5Z455G	10	4.84
		40	5Z455W	10	4.84
	Waste to Overflow Reducer – 32x21.5mm – solvent weld	32	1E344B	5	8.10
		32	1E344W	5	8.10
	– 40x21.5mm – solvent weld	40	1E346B	5	8.10
		40	1E346W	5	8.10
	Reducer to 21.5mm pipe – synthetic rubber	32	4Z343G	10	6.18
	Reducer to 35mm copper pipe – synthetic rubber	40	5Z344G	10	6.37
	Reducer – 2"/50mm x 1¼"/32mm – synthetic rubber	50	2Z347G	5	11.80
	Reducer to 42mm copper pipe – synthetic rubber	50	2Z349G	5	11.18
	Level Invert Reducer – 1½"/40mm x 1¼"/32mm	40	5Z085B	5	6.44
		40	5Z085G	5	6.44
		40	5Z085W	5	6.44
Air Admittance Valve					
	OsmaVent 40 Air Admittance Valve – fits 1¼" / 32mm and 1½" / 40mm pipe	40	4S303W	1	124.10







Wavin Osma Waste





PP Push-fit waste

Description		Nom dia mm	Cat no	Pack qty	Price £ per piece
	Pipe P/E Pipe – 3.0 metre				
	♥	32	4W073B	10	18.55
	♥	32	4W073G	10	18.55
	♥	32	4W073W	10	18.55
	♥	40	5W073B	10	21.47
	♥	40	5W073G	10	21.47
	♥	40	5W073W	10	21.47
	♥	50	2W073G	5	36.09
♥	50	2W073W	5	36.09	
	Bracket Pipe Bracket				
	♥	32	4W081B	30	1.63
	♥	32	4W081G	30	1.63
	♥	32	4W081W	30	1.63
	♥	40	5W081B	30	1.55
	♥	40	5W081G	30	1.55
	♥	40	5W081W	30	1.55
	♥	50	2W081G	20	2.69
♥	50	2W081W	20	2.69	
	Socket Double Socket				
	♥	32	4W105B	15	5.34
	♥	32	4W105G	15	5.34
	♥	32	4W105W	15	5.34
	♥	40	5W105B	15	5.70
	♥	40	5W105G	15	5.70
	♥	40	5W105W	15	5.70
	♥	50	2W105G	5	9.66
♥	50	2W105W	5	9.66	
	Bends Knuckle Bend – 90°				
	♥	32	4W160B	10	4.94
	♥	32	4W160G	10	4.94
	♥	32	4W160W	10	4.94
	♥	40	5W160B	30	4.95
	♥	40	5W160G	30	4.95
	♥	40	5W160W	30	4.95
	♥	50	2W160G	5	9.66
♥	50	2W160W	5	9.66	
	Bend – 87.5°				
	♥	32	4W161B	10	5.34
	♥	32	4W161G	10	5.34
	♥	32	4W161W	10	5.34
	♥	40	5W161B	10	5.34
	♥	40	5W161W	10	5.34
	Bend – 45°				
	♥	32	4W163B	15	5.34
	♥	32	4W163G	15	5.34
	♥	32	4W163W	15	5.34
	♥	40	5W163B	20	4.94
	♥	40	5W163G	20	4.94
	♥	40	5W163W	20	4.94
	♥	50	2W163G	5	10.21
♥	50	2W163W	5	10.21	

Wavin Osma Waste











PP Push-fit waste









Description		Nom dia mm	Cat no	Pack qty	Price £ per piece
	Spigot Bend – 30°				
	▽	32	4W166B	10	4.94
	▽	32	4W166W	10	4.94
	▽	40	5W166B	5	4.94
	▽	40	5W166G	5	4.94
	▽	40	5W166W	5	4.94
	Spigot Bend – 90°				
	▽	32	4W260B	10	5.70
	▽	32	4W260G	10	5.70
	▽	32	4W260W	10	5.70
	▽	40	5W260B	10	5.70
	▽	40	5W260G	10	5.70
	▽	40	5W260W	10	5.70
	▽	50	2W260W	5	9.43
	Tee				
	Tee – 87.5°				
	▽	32	4W190B	15	5.70
	▽	32	4W190G	15	5.70
	▽	32	4W190W	15	5.70
	▽	40	5W190B	10	4.95
	▽	40	5W190G	10	4.95
	▽	40	5W190W	10	4.95
	▽	50	2W190G	5	9.43
	▽	50	2W190W	5	9.43
	Plug				
	Access Plug				
	▽	32	4W292B	5	5.34
	▽	32	4W292G	5	5.34
	▽	32	4W292W	5	5.34
	▽	40	5W292B	5	4.94
	▽	40	5W292G	5	4.94
	▽	40	5W292W	5	4.94
	▽	50	2W292G	10	9.66
	▽	50	2W292W	10	9.66
	Connectors and Adaptors				
	Universal Connector				
	– for BS EN 1329, 1451, 1455 and 1566 pipe				
	▽	32	4W102B	10	10.21
	▽	32	4W102G	10	10.21
	▽	32	4W102W	10	10.21
	▽	40	5W102B	5	10.21
	▽	40	5W102G	5	10.21
	▽	40	5W102W	5	10.21
	▽	50	2W102G	10	9.82
	Tank Connector				
	▽	40	5W185B	5	6.35

Description		Nom dia mm	Cat no	Pack qty	Price £ per piece
	Reducers Reducer – 1½" / 40mm x 1¼" / 32mm	40	5W084B	5	4.94
		40	5W084G	5	4.94
		40	5W084W	5	4.94
	Reducer – 2" / 50mm x 1¼" / 32mm	50	2W088G	5	8.43
		50	2W088W	5	8.43
	Reducer – 2" / 50mm x 1½" / 40mm	50	2W086G	5	9.43
		50	2W086W	5	9.43
	Reducer 32 x 21.5mm – Push-fit 40 x 21.5mm – Push-fit	32	1C344W	5	8.10
		40	1C346W	10	8.10
	Air Admittance Valve OsmaVent 40 Air Admittance Valve – fits 1¼" / 32mm and 1½" / 40mm pipe	40	4S303W	1	124.10

Wavin Osma Waste













Waste connectors and V-Joint traps

	Description	Nom dia mm	Cat no	Pack qty	Price £ per piece
	Flexible Waste Pipe Flexible Connector 450mm	40	5V901W	1	36.52
<hr/>					
	Bottle Traps Bottle Trap – 38mm seal	32 40	4V809W 5V809W	1 1	29.66 39.40
	Bottle Trap – 75mm seal	32 40	4V812W 5V812W	1 1	36.94 45.20
	Anti-Syphon Bottle Trap – 75mm seal	32 40	4V814W 5V814W	1 1	49.24 62.15
	Resealing Bottle Trap – 75mm seal	32 40	4V816W 5V816W	1 1	49.24 62.16
	Adjustable Bottle Trap – 75mm seal	32 40	4V808W 5V808W	1 1	53.35 63.98
<hr/>					
	Tubular Traps Tubular 'P' Trap – 75mm seal	32 40	4V801W 5V801W	1 1	28.28 32.17
	Tubular 'S' Trap – 75mm seal	32 40	4V803W 5V803W	1 1	34.60 51.84
	Adjustable Tubular 'P' Trap – 75mm seal	32 40	4V807W 5V807W	1 1	41.98 48.89
	Variform Trap – 75mm seal	32	4V804W	1	53.08
	Running 'P' Trap – 75mm seal	40	5V805W	1	56.76

Description		Nom dia mm	Cat no	Pack qty	Price £ per piece
	Straight Through Trap – 75mm seal	32	4V825W	1	47.11
	Swivel 'P' Trap	32	4V811W	10	25.19
		40	5V811W	10	27.35
Bath Traps					
	Bath Trap – 38mm seal	40	5V802W	1	37.62
	Bath Trap – shallow seal	32	4V806W	1	30.74
		40	5V806W	1	25.51
	Bath Trap – 75mm seal	40	5V846W	1	47.74
	Bath Trap and Overflow – 75mm	40	5V848W	1	120.04
	Anti-Syphon Bath Trap	40	5V842W	1	52.39
	Bath Trap Extended Body – 60mm seal	40	5V860W	1	105.43
Shower Traps					
	Shower Trap – 19mm seal	40	5V823W	1	61.99



Wavin Osma Waste

Waste connectors and V-Joint traps

Description	Nom dia mm	Cat no	Pack qty	Price £ per piece
 Floor Gullies Floor Gully – c/w stainless steel tile and grid	50	2V502G	1	186.67
 Rubber Boss Adaptor * – 2" / 50 plastic or copper pipe	32 40 50	2S498B 2S499B 2S503B	10 10 10	15.52 15.52 16.20
* for use with Osma 2V502 Floor Gully only  Stainless Steel Tile and Grid	-	2V414G	1	213.22
 Gully Funnel	-	2V418G	1	34.72
Washing Machine Sink Traps				
 Washing Machine Half Trap – 75mm seal	40	5V864W	1	56.99
 Adjustable Sink Trap – 75mm seal	40	5V869W	1	83.65
 Tubular Swivel Sink Trap – 40mm x 75mm (adjustable) with 19/22mm connection	40	5V407W	1	73.97
 Washing Machine Trap Kit Includes stand pipe and 2 brackets – 75mm seal	40	5V870W	1	48.73
 Washing Machine Tee Piece	40	5V871W	1	23.06
Ancillaries				
 Conversion Bend – 90° – for "P" Trap to convert to "S" Trap	32 40	4A830W 5A830W	20 10	8.94 9.59
 Top Trap Washer	40	5V002W	50	2.90
 Bottle Trap Bowl Washer – for 4V809/4V812, 5V809/5V812	32	4V003W	50	3.58









Wavin Osma Waste



Condensate drainage

Description	Nom dia mm	Cat no	Pack qty	Price £ per piece
 <p>Connectors and Adaptors Tubular Swivel Trap – 40mm x 75mm (adjustable) with 21.5mm connection</p>	40	5V407W	1	73.97
 <p>Tubular Swivel Trap – 40mm x 75mm (adjustable) with 21.5mm connection and washing machine nozzle</p>	40	5V468W	1	84.85
 <p>Reducer – to 21.5mm pipe – synthetic rubber</p>	32	4Z343G	10	6.18

Wavin Osma Overflow





ABS / PVC-U Solvent Weld and PP Push-fit

	Description	Nom dia mm	Cat no	Pack qty	Price £ per piece
	Pipe				
	P/E Pipe 3.0m Solvent 4.0m Push-fit	21.5 21.5	1E073W 1C074W	10 10	13.72 16.25
	Pipe Clip Solvent Push-fit	21.5	1E082W	10	1.96
	Double Socket				
	Solvent Push-fit	21.5 21.5	1E104W 1C104W	30 10	5.62 5.41
	Bends				
	Solvent – 90° Push-fit – 90°	21.5 21.5	1E160W 1C160W	10 30	5.82 5.25
	Solvent – 45° Push-fit – 45°	21.5 21.5	1E166W 1C163W	10 20	6.67 6.42
	Solvent – 25°	21.5	1E163W	10	6.67
	Tee				
	Solvent – 90° Push-fit – 90°	21.5 21.5	1E190W 1C190W	5 5	7.19 7.54
	Tank Connectors				
	Straight Tank Connector	21.5	1E129W	5	8.75
	Bent Tank Connector 90° Solvent 90° Push-fit – cut off bend to convert to straight connector	21.5 21.5	1E139W 1C139W	5 5	9.77 9.84
	Reducers				
	Reducer Solvent Weld				
	32x21.5mm	32	1E344B	5	8.10
	32x21.5mm	32	1E344W	5	8.10
	40x21.5mm	40	1E346B	5	8.10
	40x21.5mm	40	1E346W	5	8.10
Reducer Push-fit					
32x21.5mm	32	1C344W	5	8.10	
40x21.5mm	40	1C346W	10	8.10	

Description	Nom dia mm	Cat no	Pack qty	Price £ per piece
 <p>Cap and Lining Cap and Lining</p>	21.5	1E156W	20	8.14
Adaptors				
 <p>Compression Fitting Adaptor – straight – for connection to BS 659 compression fitting and 23mm plastic overflow pipe.</p>	21.5	1O158W	10	5.41
 <p>Compression Fitting Adaptor – 90° – for connection to BS 659 compression fitting and 23mm plastic overflow pipe.</p>	21.5	1O159W	10	6.42



Wavin Osma Hep_vO Waste

Hygienic self-sealing waste valves – Polypropylene

Description	Nom dia mm	Cat no	Pack qty	Price £ per piece
 <p>Hep_vO Hygienic Self Sealing Waste Valve Hep_vO Valve</p>	32 40	BV1 WH CV1 WH	10 10	40.89 40.89
 <p>Hep_vO Knuckle Adaptor Hep_vO 87.5° Knuckle Adaptor</p>	32 40	BV11 WH CV11 WH	10 10	10.32 10.32
 <p>Hep_vO Running Adaptor For installing Hep_vO in a pipe run</p>	32 40	BV3 WH CV3 WH	10 10	9.83 9.83
 <p>Hep_vO Tundish Adaptor Hep_vO Tundish Adaptor Kit</p>	32	BV1/21 WH	5	55.29

Wavin Osma Problem Solvers

Flexible Waste pipe

Description	Nom dia mm	Cat no	Pack qty	Price £ per piece
 Flexible Waste Pipe – Smooth Bore – use with Spigot Connectors 3.0m 3.0m 6.0m 6.0m	32	FBP3 WH	1	49.13
	40	FCP3 WH	1	49.13
	32	FBP6 WH	1	98.16
	40	FCP6 WH	1	98.16
 Spigot Connectors – To Push-fit Waste  – To Solvent Weld Waste	40	FCW6 WH	1	4.00
	32	FSBW6 WH	10	4.00
	40	FSCW6 WH	10	4.00

Flexible soil pipe

Description	Nom dia mm	Cat no	Pack qty	Price £ per piece
 Flexible Pan Connector – Long Nominal length 280mm, nominal extended length 920mm  – Short Nominal length 230mm, nominal extended length 670mm  – Extra Short Nominal length 195mm, nominal extended length 410mm	110	S170 WH	1	74.39
	110	S171 WH	1	71.30
	110	S172 WH	1	68.23

Condensate fitting

Description	Nom dia mm	Cat no	Pack qty	Price £ per piece
 Condensate Soakaway	21.5	S951 BL	1	53.88

Introduction to

Wavin Industrial and Commercial systems

Wavin's range of hot and cold plumbing and soil and waste systems have been designed for industrial and commercial applications.

The range includes Wavin AS+ acoustic soil, ideal for multi-residential projects and Wavin Compact soil for when space is at a premium.

Wavin's industrial and commercial range is backed up by dedicated expert support for specifiers and contractors.

Products are available in packs or as singles.

Key to abbreviations

B	Black	E	Olive
G	Grey	W	White

P/E – Pipe and fittings with both ends plain or with one plain end and one special end.

S/S – Pipe and fittings with one or more ring-seal or push-fit sockets, but always one plain or special end.

D/S – Fittings with ring-seal or push-fit sockets at all ends.

S/SW – Fittings with one or more ring-seal sockets but always one solvent socket.

SW/S – Fittings with one or more solvent sockets and one plain or special end.

D/SW – Fittings with solvent sockets at all ends.

Symbols

British Standards Kitemark

Identifies pipe and fittings manufactured under the BSI Kitemark Certification Scheme.

British Board of Agrément

BBA Logo Identifies non-Kitemarked fittings covered by a British Board of Agrément Certificate.

WRAS Water Regulations Advisory Scheme

Identifies pipe and fittings that are WRAS approved.

BRE Building Research Establishment

BRE identifies products that have attained BRE approval.

WIS Water Industry Specification

WIS identifies products that conform to Water Industry Specifications.

Acceptance

a) British Standards Institution

Wavin Systems comply, where applicable, with the requirements of the following British Standards:

BS EN 1566-1: 2000 – Plastic piping systems for soil and waste discharge (low and high temperature) within the building structure – Chlorinated poly (vinyl chloride) (PVC-C).

ABS pipe clips to BS EN 1455.

BS EN 1453-1:2000 – Plastics piping systems with structured-wall pipes for soil and waste discharge (low and high temperature) inside buildings. Unplasticized poly (vinyl chloride) (PVC-U). Specifications for pipes and the system.

BS EN 1329: 2001 – Plastics piping systems for soil and waste discharge (low and high temperature) within the building structure. Unplasticized poly(vinyl chloride) (PVC-U). Specifications for pipes, fittings and the system.

BS EN 1451-1: 2000 – Polypropylene waste pipe and fittings.

BS 6209: 1982 – Solvent cement for non pressure thermoplastics pipe systems.

BS EN 12380:2002 – Air admittance valves for drainage systems.

Requirements, test methods and evaluation of conformity.

b) British Board of Agrément

The system has been awarded the following certificates:

86/1643 110 and 40 Air Admittance Valves.

89/2174 110mm Adjustable Bends.

c) WRAS

Wavin Hep₂O is approved (certificate 1901900) – deemed safe for use in the supply of drinking water.

The Silicone Lubricant Spray has WRAS approval for use with potable water.

Important note:







Fittings of all product ranges must be ordered in their pack multiples as illustrated in price list.

Email: info@wavin.co.uk











Web: www.wavin.co.uk

Wavin AS+

Acoustic Soil system – Astolan® and PVC-U

	Description	Nom dia mm	Cat no	Pack qty	Price £ per piece
	Pipe				
	S/S Pipe				
	3.0m	50	3080063	123	29.72
	0.15m	110	3080030	8	44.40
	2.0m	110	3080034	1	67.51
	2.7m	110	3080035	1	75.34
	3.0m	110	3080036	1	86.32
	0.15m	160	3080044	2	74.58
3.0m	160	3080050	18	165.29	
	Couplers				
	Double Socket Coupler				
		50	3080016	18	9.36
		110	3080012	8	30.76
	160	3080014	6	59.37	
	Bends				
	Bends – 15°, 30°, 45°, 67°, 87°				
	15°	50	3079965	20	9.35
	30°	50	3079966	18	9.35
	45°	50	3079967	16	7.69
	67°	50	3079968	12	9.35
	87°	50	3079969	12	7.69
	15°	110	3079950	8	29.88
	30°	110	3079951	6	31.94
	45°	110	3079952	8	33.71
	67°	110	3079953	6	34.17
	87°	110	3079954	4	35.05
	15°	160	3079959	4	67.81
	30°	160	3079960	4	69.68
	45°	160	3079961	3	71.63
	87°	160	3079962	3	76.91
	Long Bend – 45°				
	45°	110	3080026	3	39.89
	Branches				
	Branch – 45° and 87°				
	45°	50/50	3079996	6	16.78
	87°	50/50	3079997	6	16.78
	45°	110/50	3079982	4	37.50
	87°	110/50	3079983	4	37.50
	87°	110/70	3079985	4	41.93
	45°	110/110	3079981	2	56.83
	87°	110/110	3079980	4	101.91
	45°	160/110	3079991	2	116.56
	87°	160/110	3079992	2	116.56
	45°	160/160	3079994	1	160.89
		Double Branch – 87°			
		110/110 /110	3080010	2	190.66









Note: Wavin AS+ is available in light grey.

	Description	Nom dia mm	Cat no	Pack qty	Price £ per piece
	Corner Branch – 87°	110/110 /110	3080008	2	274.93
	Shower Double Branch – 87°	110/110 /50	3080095	2	125.35
	Shower Double Branch – 87° left	110/110 /50	3080096	2	125.35
	Shower Double Branch – 87° right	110/110 /50	3080097	2	125.35
Soil & Waste Connections					
	S/S Soil Manifold	110	3065902	1	103.62
	All-Fit Reducer – 40:32mm – 1½" / 40 x 1¼" / 32 for use with 3065902	40	4Z124W*	10	11.10
	All-Fit Reduction Bend – 50:40mm – 2" / 50 x 1½" / 40 for use with 3065902	50	2S355W*	10	16.27
	All-Fit 90° Spigot Bend – 50mm – 2" / 50 for use with 3065902	50	2S356W*	5	26.78
	Repair Coupler	110 160	3080088 3080090	8 6	21.28 62.00
	Long Socket	50 110 160	3080023 3080019 3080021	5 8 3	12.94 24.84 60.65

Note: Wavin AS+ is available in light grey. * OAG discount applies.













Wavin AS+

Acoustic Soil system – Astolan® and PVC-U

Description	Nom dia mm	Cat no	Pack qty	Price £ per piece
 End Cap	50	3080106	24	8.69
	110	3080103	8	20.47
	160	3080105	8	75.30
 Reducer	110/50	3080078	6	21.32
	160/110	3080082	6	41.02
 Reducer	50/40	5Z124W	10	10.56
 Access Piece	50	3079917	6	33.94
	110	3079913	4	70.31
	160	3079915	2	166.85
Accessories				
 Wavin LKS-clamp	50	4065138	50	24.84
	110	4065141	20	24.84
	160	4065143	10	24.84
 Gasket EPDM	50	4065145	1	3.18
	110	4065188	1	2.65
	160	4065190	1	6.50
 Gasket NBR	50	4065192	1	3.18
	110	4025566	1	3.18
	160	4025568	1	3.18
 Wavin System Bracket	50	4066449	50	10.59
	110	4066452	25	15.14
	160	4066454	10	23.42
 Firecollar BM-R90	50	4026102	1	80.89
	110	4026106	1	120.67
	160	4026109	1	259.54

Wavin Solvent Soil



PVC-U Solvent Soil











	Description	Nom dia mm	Cat no	Pack qty	Price £ per piece
	Pipe P/E Pipe – 3.0m ♻️♻️	110	4S073E	2	127.01
	P/E Pipe – 4.0m ♻️♻️	110	4S074E	2	169.32
	S/S Pipe – 3.0m ♻️♻️	110	4S043E	2	132.02
	S/S Pipe – 4.0m ♻️♻️	160	6S043E	10	503.87
	S/S Pipe – 4.0m ♻️♻️	110	4S044E	2	182.51
Brackets					
	Pipe Bracket ♻️	110	4S082E	20	11.69
	Pipe Bracket ♻️	160	6S082E	1	42.86
	Socket Bracket ♻️	110	4S083E	5	15.58
Sockets					
	D/SW Double Socket ♻️	110	4S104E	10	25.69
	D/SW Double Socket ♻️	160	6S104E	1	62.25
	S/SW Single Socket ♻️	110	4S124E	5	26.75
	S/SW Single Socket ♻️	160	6S124E	5	91.57
	D/S Double Socket – for repairs ♻️	110	4S105E	1	55.48
	D/S Double Socket – for repairs ♻️	160	6S105E	1	156.31
	D/S Acoustic Socket ♻️	110	4S125E	5	40.64
Connector					
	S/S Connector to CI or clay drain socket ♻️	110	4S107E	5	46.54
Reducers					
	SW/S Reducer 110mm x 50mm ♻️	110	4S496E	5	53.29
	SW/S Reducer 160mm x 110mm ♻️	160	6S499E	1	100.47
	S/S Reducer 110mm x 50mm ♻️	110	4S096E	5	59.07
	S/S Reducer 110mm x 82mm ♻️	110	4S095E	5	54.18

Note: ♻️ Recycore Technology applies to 110mm and 160mm sizes only.

Wavin Solvent Soil











PVC-U Solvent Soil











	Description	Nom dia mm	Cat no	Pack qty	Price £ per piece
	Expansion Cap				
	Expansion Cap – with integral ring–seal	110 160	4S416E 6S416E	5 5	12.73 31.90
Bends					
	D/SW Bend 87.5°				
	▽ ▽	110 160	4S461E 6S461E	5 1	69.65 183.50
	45°				
	▽ ▽	110 160	4S463E 6S463E	5 1	69.58 187.94
	SW/S Bend 45°				
	▽	110	4S263E	5	75.36
	11.25°				
	▽	110	4S268E	5	72.71
	SW/S Long Tail Bend – 87.5°				
	▽	110	4S260E	5	80.04
	S/S Bend 87.5°				
	▽	110	4S161E	5	70.84
Offset Bends					
	SW/S Offset Bend – 67.5° (Bottom)				
	▽	110	4S435E	5	66.11
	S/SW Offset Bend – 67.5° (Top)				
	▽	110	4S440E	5	90.69
	D/SW Offset Bend – 67.5° (Top)				
	▽	110	4S450E	5	73.77
	Adjustable Bend				
	S/S Adjustable Bend – 30° ▲	110	4S173E	1	89.00

	Description	Nom dia mm	Cat no	Pack qty	Price £ per piece
	Boss Socket Adaptors SW/S Boss Adaptor (Solvent Weld) – for 1 1/4" / 32mm BS EN 1329, 1455 and 1566 pipe ▽	32	2S298E	10	13.01
	SW/S Boss Adaptor (Solvent Weld) – 1 1/2" / 40mm BS EN 1329, 1455 and 1566 pipe ▽	40	2S299E	10	12.01
	SW/S Boss Adaptor (Solvent Weld) – for 2" / 50mm BS EN 1329, 1455 and 1566 pipe ▽	50	2S403E	5	14.33
	Boss Adaptors S/S Boss Adaptor (Ring-Seal) – for 1 1/4" / 32 plastic or copper pipe ▽	32	2S398E	5	13.99
	S/S Boss Adaptor (Ring-Seal) – for 1 1/2" / 40 plastic or copper pipe ▽	40	2S399E	5	13.99
	S/S Boss Adaptor (Ring-Seal) – 2" / 50 plastic or copper pipe ▽	50	2S402E	5	18.04
	Branches D/SW Double Branch – 87.5° ▽	110	4S430E	1	246.49
	SW/S Corner Branch – 87.5° ▽	110	4S491E	1	436.24
	Access Branch D/SW Access Branch – 87.5° ▽	110	4S493E	1	186.88
	Single Branches D/SW Single Branch 45° ▽	110	4S410E	5	111.31
	SW/S Single Branch – 87.5° ▽	110	4S290E	5	98.53

Wavin Solvent Soil

PVC-U Solvent Soil

	Description	Nom dia mm	Cat no	Pack qty	Price £ per piece
	DW/S Single Branch – 87.5° ♥	110	4S490E	5	98.47
	D/SW Unequal Single Branch – 87.5° ♥	160	6S498E	1	241.71
	D/SW Single Branch – 87.5° (No Bosses) ♥	160	6S490E	1	313.31
	Single 5-Boss Branch D/SW Single 5 Boss Branch – 87.5° ♥	110	4S495E	5	102.49
	Soil Manifolds 6 Boss Manifold	110	4S597E	1	111.40
	Manifolds Soil Manifold System ♥	110	4S595E	1	122.48
	All-Fit Reducer – 40:32mm – 1½" / 40 x 1¼" / 32 for use with 4S595E	40	4Z124W	10	11.10
	All-Fit Reduction Bend – 50:40mm – 2" / 50 x 1½" / 40 for use with 4S595E	50	2S355W	10	16.27
	All-Fit 90° Spigot Bend – 50mm – 2" / 50 for use with 4S595E	50	2S356W	5	26.78
	Bossed Pipes D/SW Short Bossed Pipe – NEW	110	4S588E	5	25.46
	D/SW Bossed Pipe – plain (four boss sockets) ♥	110	4S586E	5	34.06

Description		Nom dia mm	Cat no	Pack qty	Price £ per piece
	SW/S Bossed Pipe – plain (four boss sockets) ▽	110	4S585E	5	34.06
	S/SW Bossed Pipe – plain (four boss sockets) ▽	110	4S590E	5	49.34
	D/SW Bossed Pipe (Solvent Weld) – for 1 1/4" / 32mm BS EN 1329, 1455 and 1566 pipe ▽	110	4S483E	5	30.59
	– 1 1/2" / 40mm BS EN 1329, 1455 and 1566 pipe ▽	110	4S484E	5	30.59
Strap Boss					
	Strap Boss ▽	110	4S319E	5	23.75
Access Fittings					
	D/SW Access Bend – 87.5° ▽	110	4S469E	5	175.57
	D/SW 3-Boss Access Pipe – with screwed access and three boss sockets ▽	110	4S474E	5	116.74
	SW/S 3-Boss Access Pipe – with screwed access and three boss sockets ▽ ▽	110 160	4S574E 6S474E ^Δ	5 5	116.74 264.66
Plugs					
	P/E Access Plug ▽	110	4S292E	1	55.39
	SW/S Access Plug ▽	110	4S492E	5	69.76
	P/E Socket Plug – with one boss socket ▽	110	4S296E	5	39.04

Note: ^Δ = Available on a made to order basis. Please contact us regarding lead times.







Wavin Solvent Soil

PVC-U Solvent Soil

	Description	Nom dia mm	Cat no	Pack qty	Price £ per piece
	Terminal Fittings Balloon Grating	110	4S302E	5	16.40
	Weathering Collar	110	4S300E	5	24.25
	SW/S Vent Cowl ♡	110	4S310E	1	82.82

Wavin Solvent Soil







Problem Solvers





	Description	Nom dia mm	Cat no	Pack qty	Price £ per piece
	Boss Adaptors Solvent Weld – 90°	40	2CS812SE	10	15.60
	▽	50	2CS813SE	10	22.20
	Solvent Weld – Straight	32	2CS814SE	10	13.01
	▽	40	2CS815SE	10	12.01
	▽	50	2CS816SE	10	14.33
	Push-fit – 90°	40	2CS802SE	10	22.20
	▽				
	Push-fit – Straight	32	2CS804SE	10	13.37
	▽	40	2CS805SE	10	13.37
	Double Branches D/SW Double 4-Boss Branch – 87.5°	110	4CS832SE	1	246.49
	▽				
	SW/S Double 4-Boss Branch – 87.5°	110	4CS834SE	1	246.49
	▽				
	Single Branch SW/S Single 5-Boss Branch – 87.5°	110	4CS895SE	5	102.49
	▽				
	Bossed Pipe D/SW Short 3-Boss Pipe	110	4CS588SE	1	25.46
	▽				

Note: The boss adaptors listed in this section are designed to fit the 4CS895SE; 4CS834SE; 4CS588SE and are not compatible with other bossed fittings in the Wavin Solvent Soil range.

Wavin Solvent Waste

PVC-C Solvent Weld waste





Description		Nom dia mm	Cat no	Pack qty	Price £ per piece
Pipe					
	P/E Pipe – 3.0m				
	♥	32	4M073B	10	43.28
	♥	32	4M073E	10	43.28
	♥	32	4M073W	10	43.28
	♥	40	5M073B	10	47.22
	♥	40	5M073E	10	47.22
	♥	40	5M073W	10	47.22
	♥	50	2M073B	5	72.65
	♥	50	2M073E	10	72.65
♥	50	2M073W	5	72.65	
Bracket					
	Pipe Bracket				
	♥	32	4M081E	40	1.81
	♥	40	5M081E	35	1.84
♥	50	2M081E	20	3.75	
Sockets					
	Double Socket				
	♥	32	4M104B	10	7.18
	♥	32	4M104E	20	7.18
	♥	32	4M104W	10	7.18
	♥	40	5M104B	10	9.05
	♥	40	5M104E	20	9.05
	♥	40	5M104W	10	9.05
	♥	50	2M104E	10	14.68
♥	50	2M104W	5	14.68	
	Expansion Socket – with solvent socket tail				
	♥	32	4M124E	10	15.16
	♥	32	4M124W	10	15.16
	♥	40	5M124E	10	15.84
	♥	40	5M124W	10	15.84
♥	50	2M124E	5	28.30	
♥	50	2M124W	5	28.30	
Bends					
	Knuckle Bend – 90°				
	♥	32	4M160B	30	10.73
	♥	32	4M160E	30	10.73
	♥	32	4M160W	30	10.73
	♥	40	5M160B	30	12.62
	♥	40	5M160E	30	12.62
	♥	40	5M160W	30	12.62
	♥	50	2M160B	5	22.54
	♥	50	2M160E	5	22.54
♥	50	2M160W	5	22.54	
	Bend – 87.5°				
	♥	32	4M161B	10	13.12
	♥	32	4M161E	10	13.12
	♥	32	4M161W	10	13.12
	♥	40	5M161B	40	15.84
	♥	40	5M161E	40	15.84
	♥	40	5M161W	40	15.84
	♥	50	2M161B	5	22.02
	♥	50	2M161E	5	22.02
♥	50	2M161W	5	22.02	

Description		Nom dia mm	Cat no	Pack qty	Price £ per piece
	Bend – 45°				
	♥	32	4M163B	10	9.96
	♥	32	4M163E	10	9.96
	♥	32	4M163W	10	9.96
	♥	40	5M163B	20	11.19
	♥	40	5M163E	20	11.19
	♥	40	5M163W	20	11.19
	♥	50	2M163B	5	18.92
	♥	50	2M163E	5	18.92
♥	50	2M163W	5	18.92	
	Spigot Bend – 90°				
	♥	32	4M260B	5	13.84
	♥	32	4M260E	5	13.84
	♥	32	4M260W	5	13.84
	♥	40	5M260B	10	16.72
	♥	40	5M260E	10	16.72
	♥	40	5M260W	10	16.72
	♥	50	2M260B	5	24.85
	♥	50	2M260E	5	24.85
♥	50	2M260W	5	24.85	
	Tees				
	Tee – 87.5°				
	♥	32	4M190B	5	17.14
	♥	32	4M190E	5	17.14
	♥	32	4M190W	5	17.14
	♥	40	5M190B	15	19.54
	♥	40	5M190E	15	19.54
	♥	40	5M190W	15	19.54
	♥	50	2M190B	5	30.44
♥	50	2M190E	5	30.44	
♥	50	2M190W	5	30.44	
	Plug				
	Access Plug				
	♥	32	4M292B	5	10.61
	♥	32	4M292E	5	10.61
	♥	32	4M292W	5	10.61
	♥	40	5M292B	5	10.42
	♥	40	5M292E	5	10.42
	♥	40	5M292W	5	10.42
	♥	50	2M292B	5	18.10
♥	50	2M292E	5	18.10	
♥	50	2M292W	5	18.10	
	Reducers				
	Reducer				
	1½" / 40mm x 1¼" / 32mm				
	♥	40	5M455B	10	6.67
	♥	40	5M455E	10	6.67
	♥	40	5M455W	10	6.67
	2" / 50mm x 1¼" / 32mm				
	♥	50	2M458B	5	12.59
	♥	50	2M458E	5	12.59
	♥	50	2M458W	5	12.59
	2" / 50mm x 1½" / 40mm				
♥	50	2M456B	5	12.59	
♥	50	2M456E	5	12.59	
♥	50	2M456W	5	12.59	







Note: For all push-fit ranges and ancillaries, please refer to the Osma section of the price list – see pages 45-55.

Wavin HDPE

Soil, waste and vent

Description	Nom dia mm	Cat no	Pack qty	Price £ per piece
Pipe				
 PE Pipe – 3.0m	110	3075609	1	51.07
 PE Pipe – 5.0m	40	3003465	1	24.18
	50	3003466	1	28.64
	56	3003477	1	33.73
	63	3003467	1	39.41
	75	3003468	1	45.57
	90	3003458	1	67.90
	110	3003459	1	85.10
	125	3003460	1	122.43
	160	3003461	1	191.32
	200	3003462	1	255.15
	250	3003463	1	406.43
	315	3003464	1	631.75
Reducers				
 Concentric Reducer	50/40	3084576	40	4.08
	56/50	3003820	20	4.08
	63/40	3003796 ^Δ	20	5.51
	63/50	3003797 ^Δ	20	5.51
	63/56	3003798	20	4.06
	75/50	3003800 ^Δ	20	5.97
	75/63	3003801 ^Δ	20	5.97
	90/50	3003803 ^Δ	20	6.14
	90/63	3003804 ^Δ	20	7.50
	90/75	3003805 ^Δ	20	7.50
	110/50	3003807 ^Δ	10	7.50
	110/56	3003858	10	7.43
	110/63	3003808	10	7.50
	110/75	3003809	10	7.50
	110/90	3003810	10	7.43
	125/63	3003812 ^Δ	20	11.94
	125/110	3003815	10	11.94
	160/110	3003816	5	13.25
	160/125	3003817 ^Δ	5	13.25
	200/160	3018808*	1	84.25
	250/200	3018809*	1	221.39
	315/250	3018810*	1	306.68
 Eccentric Reducer	50/40	3003821	20	4.40
	56/50	3003841	20	4.81
	63/40	3003822Q ^Δ	20	5.06
	63/50	3003823Q	20	5.06
	63/56	3003842Q	20	5.06
	75/40	3003824	20	5.80
	75/50	3003825	20	5.82
	75/56	3003843	20	5.81
	75/63	3003826	20	5.82
	90/50	3003827Q ^Δ	20	7.16
	90/63	3003828	20	7.79









Note: * = Segment Welded, Δ = Available on a made to order basis. Please contact us regarding lead times.

Description	Nom dia mm	Cat no	Pack qty	Price £ per piece
 Eccentric Reducer – continued	90/75	3003829	20	7.83
	110/40	3003830	20	8.50
	110/50	3003831	20	8.29
	110/56	3003835	20	8.48
	110/63	3003832	20	8.50
	110/75	3003833	20	8.51
	110/90	3003834	20	8.47
	125/75	3003836Q ^Δ	10	14.10
	125/90	3003837Q	10	14.10
	125/110	3003838Q	10	14.10
	160/110	3003839	5	18.57
	160/125	3003840	5	18.58
 Eccentric Reducer – Long	200/110	3018811	5	136.20
	200/125	3018812	1	134.92
	200/160	3018813	1	134.92
	250/200	3070632*	1	215.04
	315/200	3014918*	1	306.68
	315/250	3003856*	1	305.40
Elbows				
 Elbow 15°	110	3017993	20	30.70
	160	3043453 ^Δ	1	51.80
	200	3043454 ^Δ	1	59.63
	250	3043455 ^Δ	1	97.75
	315	3043457 ^Δ	1	140.22
 Elbow 30°	110	3003576	20	31.17
	160	3003584	5	47.65
 Elbow 45°	40	3084563	10	3.33
	50	3084565	10	3.36
	56	3003597	20	3.99
	63	3003569	20	5.08
	75	3003572	20	6.42
	90	3003574	20	9.33
	110	3003577	25	9.13
	125	3003582	10	14.97
	160	3003585	5	38.91
 Elbow 45° Long Tail	200	3018820	5	108.18
	250	3018821*	1	176.86
	315	3018822* ^Δ	1	244.46
	110	3075824 ^Δ	6	11.24



Note: * = Segment welded, † = Swept type, Δ = Available on a made to order basis. Please contact us regarding lead times.

Wavin HDPE

Soil, waste and vent

Description	Nom dia mm	Cat no	Pack qty	Price £ per piece	
 Elbow 88.5°	40	3084564 [†]	10	3.35	
	50	3084566 [†]	10	4.47	
	56	3003598	20	4.47	
	63	3003570 [†]	20	5.59	
	75	3003573 [†]	20	7.93	
	90	3003575	20	11.31	
	110	3003579 [†]	20	12.24	
	125	3003583 [†]	10	19.65	
	160	3003587 [†]	5	50.41	
 Elbow 90° Welded	160	3003943	10	37.93	
 Elbow 90° Segment Welded	200	3018818 [*]	1	187.13	
	250	3017978 [*]	1	312.27	
	315	3018819 ^{*Δ}	1	455.74	
 Elbow 90° Extended	40	3084577	10	3.33	
	50	3084567	10	3.96	
	56	3003944	20	4.74	
	63	3003601 ^Δ	20	6.99	
	75	3003622	25	8.47	
	90	3003602	25	11.31	
	125	3003605 ^Δ	10	20.66	
 Airmix HDPE Airmix "sovent"	110	3003791 ^Δ	23	134.68	
	160	4042219 ^Δ	10	459.84	
 Branches Swept Branch 88.5°	110	3003792	10	18.66	
	 Double Branch 45°	90/50	3018005 ^Δ	10	40.30
		100/50	3003730 ^Δ	10	27.72
		110/110	3003728	5	30.90
 Branch 45°	40/40	3084570	20	8.16	
	50/40	3084574	25	8.47	
	50/50	3084572	25	8.41	
	56/50	3003725Q	20	7.71	
	56/56	3003724	20	8.00	
	63/40	3003635Q ^Δ	20	8.58	





Note: * = Segment welded, † = Swept type, Δ = Available on a made to order basis. Please contact us regarding lead times.

Description	Nom dia mm	Cat no	Pack qty	Price £ per piece
 Branch 45° – continued	63/50	3003637Q	20	9.06
	63/56	3003639Q	20	5.79
	63/63	3003633	20	8.83
	75/40	3003643Q	20	11.38
	75/50	3003645Q	20	10.80
	75/56	3003649	20	9.87
	76/63	3003647Q	20	7.54
	75/75	3003641	20	9.82
	90/40	3003654Q	10	14.77
	90/50	3003656Q	10	16.89
	90/63	3003658Q ^Δ	10	20.53
	90/75	3003660Q ^Δ	10	22.06
	90/90	3003651Q ^Δ	15	19.90
	110/40	3003664 ^Δ	10	16.39
	110/50	3003666	10	16.83
	110/56	3003674	10	16.31
	110/63	3003668	10	16.83
	110/75	3003670	10	17.00
	110/90	3003672Q ^Δ	10	20.70
	110/110	3003662	15	17.10
	125/50	3003678Q	10	30.55
	125/63	3003679 ^Δ	10	22.45
	125/75	3003681Q ^Δ	10	27.74
	125/90	3003683Q ^Δ	10	31.27
	125/110	3003685	10	22.45
	125/125	3003676 ^Δ	5	22.68
	160/110	3003688	5	78.09
	160/125	3003690 ^Δ	5	78.16
	160/160	4009725	5	77.07
	200/110	3070633*	5	168.06
	200/125	3018824Q ^Δ	1	182.15
	200/160	3070634*	5	175.51
	200/200	3070630*	5	251.99
	250/110	3003705*	1	281.30
	250/125	3003707Q ^Δ	1	234.86
250/160	3003709*	1	311.30	
250/200	3003710*	1	311.50	
250/250	3018826*	1	428.65	
315/110	3003723*	1	497.31	
315/125	3018827 ^Δ	1	367.95	
315/160	3018828*	1	496.99	
315/200	3003718*	1	520.47	
315/250	3003719*	1	526.92	
315/315	3018829*	1	628.69	
 Branch 88.5°	40/40	3084571	20	6.64
	50/40	3084575	20	8.48
	50/50	3084573	20	8.47
	56/50	3003726	20	8.47
	56/56	3003727	20	8.43
	63/50	3003638	20	8.76
	63/63	3003634 ^Δ	20	10.41
	75/50	3003646 ^Δ	20	10.36
	75/56	3003650	20	10.36







Note: * = Segment Welded, Δ = Available on a made to order basis. Please contact us regarding lead times.

Wavin HDPE

Soil, waste and vent









Description	Nom dia mm	Cat no	Pack qty	Price £ per piece
 Branch 88.5° – continued	75/63	3003648 ^Δ	20	13.20
	75/75	3003642	20	10.41
	90/40	3003655	10	13.25
	90/50	3003657	10	13.20
	90/63	3003659 ^Δ	10	13.20
	90/75	3003661 ^Δ	10	19.36
	90/90	3003652	10	13.17
	110/40	3003665	10	15.71
	110/50	3003667	10	15.71
	110/56	3003675	10	16.23
	110/63	3003669 ^Δ	10	16.23
	110/75	3003671	10	15.14
	110/90	3003673 ^Δ	10	16.23
	110/110	3003663	15	15.19
	125/63	3003680 ^Δ	10	22.59
	125/110	3003686 ^Δ	10	22.59
	125/125	3003677	10	22.59
	160/110	3003689	5	84.39
	160/125	3003691 ^Δ	5	64.50
	160/160	3003687	5	83.53
	200/110	3003698*	20	168.06
	200/125	3018830 ^Δ	1	168.06
	200/160	3003702*	1	167.34
	200/200	3018831*	1	167.34
	250/110	3018002*	1	239.15
	250/125	3018832 ^Δ	1	239.15
	250/160	3018003*	1	240.68
	250/200	3018833*	1	241.38
	250/250	3003704*	1	240.51
	315/110	3018834 ^{*Δ}	1	281.30
	315/125	3003716 ^Δ	1	281.30
	315/160	3018835 ^{*Δ}	1	281.30
	315/200	3018836 ^{*Δ}	1	283.96
315/250	3018837 ^{*Δ}	1	283.14	
315/315	3003713 ^{*Δ}	1	340.66	
 Boss Pipe Boss Pipe – Four Way Extended Spigot	110/56	3075823	6	48.47
Connectors and Adaptors Universal Connector ♡ ♡	40	5W102G •	5	10.21
	50	2W102G •	10	9.82
 Expansion Socket – with Solvent Socket Tail ♡	50	2Z124W •	5	18.34
 Long-Tail Bend – 87.5°	50	2Z359G •	5	21.44

* OAG discount applies.





Description		Nom dia mm	Cat no	Pack qty	Price £ per piece
	Rubber Boss Adaptor	56/32	4063088 ^Δ	1	12.08
		56/40	4063089 ^Δ	1	12.24
Brackets					
	Galvanised HDPE Bracket M10 Connection	40	4012113	10	4.88
		50	4012117	10	6.73
		56	4063090 ^Δ	1	6.90
		63	4012121 ^Δ	10	7.06
		75	4012125	10	7.34
		90	4012131	10	7.88
		110	4012137	10	8.62
		125	4012141	10	9.04
		160	4012146	10	10.06
	Bracket Insert	40	4012329	50	4.46
		50	4012331	50	8.94
		56	4063093 ^Δ	25	9.16
		63	4012333 ^Δ	50	10.73
		75	4012335	50	9.16
		90	4012337	50	9.42
		110	4012339	50	7.30
		125	4012341 ^Δ	50	9.92
		160	4012343	50	8.20
		200	4012345	20	35.00
		250	4023375	20	41.18
		315	4023376	20	46.95
			Galvanised HDPE Bracket	50 x 1/2"	4012118
56 x 1/2"	4063094 ^Δ			50	8.58
63 x 1/2"	4012122			10	8.58
75 x 1/2"	4012126			10	8.65
90 x 1/2"	4012132			10	9.91
110 x 1/2"	4012138			10	10.01
125 x 1/2"	4012142			10	9.87
160 x 1/2"	4012147			10	12.24
200 x 1"	4012151			10	36.47
250 x 1"	4012155			10	36.97
315 x 1"	4012159			10	43.05
	Mounting Plate	M10	4063092 ^Δ	50	6.39
		G 1/2"	4012326	50	6.39
	Fire Collar EFM	40	4063766	1	22.53
		50	4063767	1	22.53
		63	4063768	1	22.53
		75/78	4063769	1	28.64
		90	4063770 ^Δ	1	28.64
		110	4026438	1	30.76
		125	4026439 ^Δ	1	31.93
		160	4063772	1	48.12
		200	4026441 ^Δ	1	157.05
		250	4026442 ^Δ	1	326.52

Wavin HDPE

Soil, waste and vent

	Description	Nom dia mm	Cat no	Pack qty	Price £ per piece
Spherical Branches					
	Spherical Branch, 2 Stubs Type A – 180°	110/110	3003755	5	57.06
	Type B – 90°	110/110	3003756	5	56.59
	Spherical Branch, 3 Stubs Type E – 90°	110/110	3003776 ^Δ	5	68.89
	Spherical Branch, 4 Stubs Type F – 90°	110/110	3003777	5	76.47
Access Tees					
	Access Tee 45°	110/110	3003739	5	48.62
		125	3003741 ^Δ	5	60.83
		160/110	3003743	5	120.17
	Access Tee 88.5°	50	3003732 ^Δ	10	26.25
		63	3003734 ^Δ	10	33.43
		75/75	3003736	10	36.63
		90	3003738Q ^Δ	10	50.69
		110/110	3003740	10	50.41
		125	3018815Q ^Δ	10	44.65
		160/110	3070631*	5	119.17
		200/110	3017974*	1	198.20
250/110	3017975*	1	254.68		
315/110	3017976*	1	307.61		
Toilet Connectors					
	Wall Mounted Toilet Connector	90/90	3003550 ^Δ	10	30.79
		110/110	3003554 ^Δ	10	30.03
	Wall Mounted Toilet Connector Elbow 90° for hanging toilets	90/90	3003619 ^Δ	10	57.81
		110/90	3018007 ^Δ	10	57.60
		110/110	3003620 ^Δ	10	57.43
	Wall Mounted Double Toilet Connector Elbow 90°	110/110	3003621 ^Δ	5	116.05







Note: * = Segment Welded, Δ = Available on a made to order basis. Please contact us regarding lead times.













Description	Nom dia mm	Cat no	Pack qty	Price £ per piece
 Electro-fusion Coupler – Universal Type (WAVIDUO)	40	3003478	20	7.66
	50	3003479	20	7.83
	56	3003489	20	7.84
	63	3003480	20	8.09
	75	3003481	20	11.27
	90	3003482	20	10.98
	110	3003483	20	11.53
	125	3003484	10	20.39
	160	3003485	24	26.39
	200	4061068	6	195.73
	250	4064881	2	327.53
	315	4064882	2	372.72
Sockets, Caps and Flange Adaptors				
 Push-fit Socket with Gasket and Cap	40/40	3084561	10	5.62
	50/50	3084562	10	6.71
	56/56	3003493	20	7.49
	63/63	3003494 ^Δ	20	7.49
	75/75	3003495	20	10.65
	90/90	3003496 ^Δ	20	10.65
	110/110	3003497	20	13.52
	125/125	3003498 ^Δ	10	21.53
160/160	3003499	18	42.46	
 Expansion Socket with Gasket and Cap	40/40	3003505	20	14.83
	50/50	3003506	20	14.65
	56/56	3018008	15	14.00
	63/63	3003507	20	17.52
	75/75	3003508	20	18.61
	90/90	3003509	10	19.09
	110/110	3003510	20	19.58
	125/125	3003511 ^Δ	10	29.75
	160/160	3003512	5	54.02
	200/200	3003513*	15	250.38
250/250	3070629	1	367.86	
315/315	3003515	1	634.51	
 Complete Screw Connection	40	3003905 ^Δ	20	9.46
	50	3003935 ^Δ	20	9.46
	63	3003936 ^Δ	10	16.08
	75	3003937 ^Δ	10	16.08
	110	3003938 ^Δ	10	26.58
 Complete Closing Cap	40	3003869	10	9.95
	50	3003870	10	10.10
	63	3003871 ^Δ	10	10.10
	75	3082542	10	23.63
	90	3003872 ^Δ	10	23.86
	110	3003873	10	32.14

Note: ^Δ = Available on a made to order basis. Please contact us regarding lead times.

Wavin HDPE

Soil, waste and vent

Description	Nom dia mm	Cat no	Pack qty	Price £ per piece
 Weld Cap	40	3003860	20	4.18
	50	3003861	20	3.56
	56	3003874	20	3.56
	63	3003862 ^Δ	20	3.56
	75	3003863	20	3.57
	90	3003865 ^Δ	20	4.51
	110	3003866	20	8.47
	125	3003867 ^Δ	10	10.57
	160	3003868	10	34.16
 Protection Cap for pipe & fittings	40	3018704 ^Δ	40	4.39
	50	3018705 ^Δ	40	5.72
	63	3018706 ^Δ	40	5.72
	75	3018707 ^Δ	40	6.64
	90	3018708	50	1.07
	110	3018709	40	1.20
	125	3018710 ^Δ	50	6.64
 Flange Cap	110	3072765	1	275.12
	160	3043503	1	275.12
	200	3043504	1	361.56
	250	3043505	1	376.21
	315	3043506	1	552.18
 Flange Adaptor	50	4025986 ^Δ	5	35.02
	63	4025988 ^Δ	5	48.78
	75	4025989 ^Δ	5	35.02
	110	4009748	5	38.94
	125	4009749 ^Δ	5	77.00
	160	4009750 ^Δ	5	66.31
	200	4009751 ^Δ	5	127.47
	250	4025992 ^Δ	1	219.44
	315	3018031 ^Δ	1	374.17
 Galvanised Steel Flange 1"	1"	4009793	20	7.90
 Brass Nut Connection	40x3/4"	3003908 ^Δ	20	11.46
	40x1"	3003910 ^Δ	20	11.46
	40x1 1/4"	3003912 ^Δ	20	11.46
	40x1 1/2"	3003913 ^Δ	20	11.46
	50x3/4"	3003917 ^Δ	20	27.04
	50x1 1/4"	3003921 ^Δ	20	27.04
	50x1 1/2"	3003924 ^Δ	20	27.04
	50x2"	3003927 ^Δ	20	27.04
63x2"	4009761 ^Δ	10	11.46	
 Shrink-on Socket with Seal	50	3003516 ^Δ	5	40.62
	63	3018026 ^Δ	5	40.62
	75	3018027 ^Δ	5	40.62
	90	3018028 ^Δ	5	40.62
	110	3003528 ^Δ	5	48.69
	125	3018029 ^Δ	5	48.69
	160	3018030 ^Δ	5	70.90
	200	3018025 ^Δ	1	84.76

Description		Nom dia mm	Cat no	Pack qty	Price £ per piece
Accessories					
	Electrofusion Welding Tool DUO 315 230v	–	4036330	1	3507.35
	Electrofusion Welding Tool WaviDUO 315 110v	–	4064999	1	POA
	Electrofusion Welding Tool Cable 40-160 Spare, for use with 4064999	–	4065001	1	358.96
	Electrofusion Welding Tool Cable 200-315 Spare, for use with 4064999	–	4065000	1	358.96
	Welding Mirror Complete with metal case Class X1, TP200	160	4011403	1	884.60
	Heat Reflector Butt-Welding Tool Maxi 315, 90-315mm	90-315	4011402 ^Δ	1	POA
	PE Pipe Cutter	40-63	4026014 ^Δ	1	399.55
		50-125	4011390	1	658.21
		110-160	4011393	1	673.05
		200-315	4011396	1	3193.25
	HDPE Rotary Peelers for pipe 50mm	50	4042914	1	2099.85
	for pipe 63mm	63	4024493	1	2099.85
	for pipe 75mm	75	4024569	1	2512.31
	for pipe 90mm	90	4024432	1	2512.31
	for pipe 110mm	110	4024189	1	2512.31
	for pipe 125mm	125	4024393	1	2512.31
	for pipe 160mm	160	4024190	1	2924.81
	Replacement blade	–	4042915	1	217.48
	Other Processing Aids PE marker pen China Marker	–	4011453	12	19.54
	PE pipe scraper	–	4020757	10	68.49
	PE cleaner 0.7 litre bottle	–	4025509	12	40.13

Note: ^Δ = Available on a made to order basis. Please contact us regarding lead times.

Introduction to

Wavin Tigris – Press-Fit Plumbing System

Wavin Tigris Press-fit plumbing system is a multilayer, composite pipe, press-fit plumbing system designed for potable water, sanitary and heating applications. It is ideally suited for installation on commercial projects such as educational establishments, high rise residential and hotels. Widely specified and accorded a design award in Europe, Wavin Tigris is the proven and perfected system for commercial plumbing and heating projects and has a number of features and benefits,

All Wavin Tigris systems offer quick, simple and safe jointing method with no hot works permit required. The system is lightweight and corrosion resistant, with high resistance to scale build-up, stress-cracking, pressure and temperature. With a thermal expansion comparable with copper, Wavin Tigris is the perfect solution for commercial projects.

Wavin Tigris K5/M5 – the fitting that will blow you away!

NEW for 2023, Wavin have launched the Tigris K5 and M5 range of fittings in 16, 20, 25, 32 and 40mm diameter. These retain all the features of the K1 system, but with lots of additional benefits.

Key Features and benefits

- **Unique acoustic leak detection, any unpressed joints make a whistling noise so you can easily locate after installation**
- **Optiflow – designed for increased flow rate with up to 50% larger inner bore**
- **Flexible, multi-layer pipe requires minimal fittings reducing installation time and cost and improving flow rates**
- **Multi jaw – can be used with most available jaws meaning no new tools needed**
- **In4Sure technology ensuring full pipe insertion**
- **Guaranteed for 25 years and WRAS approved**
- **Defined leak function to reveal unpressed fittings when air testing not possible**

The range uses the same Tigris pipe and is fully compatible with the Tigris K1 system.

All tools in the range can be used with either system.

Find out more at wavin.co.uk/tigris-press-fit

Wavin Tigris K5







Press-fit plumbing system

Description	Nom dia mm	Cat no	Pack qty	Price £ per piece
Pipe				
 Pipe – Straight Lengths				
16mm x 2.0mm x 3m	16	3072958	25	12.14
16mm x 2.0mm x 5m	16	3061211	25	20.77
20mm x 2.25mm x 3m	20	3072989	18	17.39
20mm x 2.25mm x 5m	20	3061212	18	29.89
25mm x 2.5mm x 3m	25	3072990	10	26.47
25mm x 2.5mm x 5m	25	3061213	10	45.35
32mm x 3.0mm x 3m	32	3070827	6	33.14
32mm x 3.0mm x 5m	32	3041228	6	56.86
40mm x 4.0mm x 5m	40	3041229	4	91.69
 Pipe – Coils				
16mm x 2.0mm x 100m	16	3018297	1	327.36
16mm x 2.0mm x 200m	16	3018302	1	654.69
16mm x 2.0mm x 500m	16	3061202	1	1553.79
20mm x 2.25mm x 100m	20	3018299	1	462.85
25mm x 2.5mm x 50m	25	3018300	1	375.38
32mm x 3.0mm x 50m	32	3018301	1	514.59
 Pipe – Coil 9mm Pre-insulated				
32mm x 3.0mm x 25m GREY	32	3018804	1	509.40
 Pipe – Coils 9mm Pre-insulated				
16mm x 2.0mm x 50m RED	16	3004378	1	350.07
20mm x 2.25mm x 50m RED	20	3004379	1	466.38
25mm x 2.5mm x 25m RED	25	3071219	1	304.88
16mm x 2.0mm x 50m BLUE	16	3071220	1	350.07
20mm x 2.25mm x 50m BLUE	20	3071221	1	466.38
25mm x 2.5mm x 25m BLUE	25	3071222	1	325.45
 Pipe – Coils 13mm Pre-insulated				
16mm x 2.0mm x 50m RED	16	3004380	1	412.40
20mm x 2.25mm x 50m RED	20	3004381	1	514.30
25mm x 2.5mm x 25m RED	25	3070529	1	382.06
16mm x 2.0mm x 50m BLUE	16	3071224	1	412.40
20mm x 2.25mm x 50m BLUE	20	3071225	1	514.30
25mm x 2.5mm x 25m BLUE	25	3071226	1	382.06
Couplers				
 Straight Coupler				
16mm	16	3079754	10	4.29
20mm	20	3079755	10	5.59
25mm	25	3079756	10	8.40
32mm	32	3079757	5	14.61
40mm	40	3079758	3	23.27
 Reducing Coupler				
20 x 16mm	20	3079759	10	5.96
25 x 16mm	25	3079760	10	7.71
25 x 20mm	25	3079761	10	8.43
32 x 20mm	32	3079762	5	14.26
32 x 25mm	32	3079763	5	13.97
40 x 32mm	40	3079764	3	22.41

Wavin Tigris K5









Press-fit plumbing system







Description	Nom dia mm	Cat no	Pack qty	Price £ per piece	
Elbows					
 Elbow 45°	25	3079773	10	11.40	
	32	3079774	5	16.56	
	40	3079775	3	31.73	
 Elbow 90°	16	3079768	10	5.35	
	20	3079769	10	6.73	
	25	3079770	10	9.55	
	32	3079771	5	14.89	
	40	3079772	3	29.14	
 Elbow 90° – single male BSP thread	16mm x 1/2"	16	3079776	10	6.77
	20mm x 1/2"	20	3079777	10	8.25
	20mm x 3/4"	20	3079778	10	11.91
	25mm x 3/4"	25	3079779	10	13.27
	25mm x 1"	25	3079780	5	14.84
	32mm x 1"	32	3079781	5	23.68
	 Elbow 90° – single female BSP thread	16mm x 1/2"	16	3079782	10
20mm x 1/2"		20	3079783	10	13.08
20mm x 3/4"		20	3079784	10	15.94
25mm x 3/4"		25	3079785	10	17.83
32mm x 1"		32	3079786	5	27.09
 Backplate Elbow – female BSP thread		16mm x 1/2"	16	3079854	10
	20mm x 1/2"	20	3079855	10	17.25
	20mm x 3/4"	20	3079856	10	17.83
 Toilet Tank Elbow	16mm x 1/2"	16	3083259	10	17.07
Tees					
 Equal Tee	16	3079811	10	7.27	
	20	3079812	10	10.41	
	25	3079813	5	14.95	
	32	3079814	5	25.48	
	40	3079815	2	41.71	
 One End Reduced Tee 20x20x16mm	20	3079824	10	9.53	
 Double End Reduced Tee	16x20x16mm	20	3079821	10	9.53
	20x25x20mm	25	3079826	5	13.02
	25x32x25mm	32	3079833	5	21.00

	Description	Nom dia mm	Cat no	Pack qty	Price £ per piece
	Branch Reduced Tee				
	20x16x20mm	20	3079823	10	9.53
	25x16x25mm	25	3079827	5	13.19
	25x20x25mm	25	3079828	5	14.36
	32x16x32mm	32	3079834	5	20.00
	32x20x32mm	32	3079835	5	21.36
	32x25x32mm	32	3079837	5	23.12
	40x25x40mm	40	3079839	2	32.56
	Branch and One End Reduced Tee				
	20x16x16mm	20	3079822	10	9.53
	25x16x16mm	25	3079829	5	12.31
	25x20x20mm	25	3079825	5	13.22
	32x25x25mm	32	3079836	5	21.07
	40x32x32mm	40	3079842	3	32.03
	One Sided Female Thread Tee				
	16mm x 1/2" x 16mm	16	3079816	10	17.55
	20mm x 1/2" x 20mm	20	3079817	10	19.58
	20mm x 3/4" x 20mm	20	3079818	10	20.35
	25mm x 1/2" x 25mm	25	3079819	5	18.20
	25mm x 3/4" x 25mm	25	3079820	5	25.29
Connectors					
	Connector – single male BSP thread				
	16mm x 1/2"	16	3079798	10	5.37
	16mm x 3/4"	16	3079799	10	6.24
	20mm x 1/2"	20	3079800	10	6.85
	20mm x 3/4"	20	3079801	10	7.58
	25mm x 3/4"	25	3079802	10	8.66
	25mm x 1"	25	3079803	10	11.26
	32mm x 1"	32	3079804	5	16.51
	32mm x 1 1/4"	32	3079805	5	24.79
	40mm x 1 1/4"	40	3079806	3	27.20
	Connector – single female BSP thread				
	16mm x 1/2"	16	3079788	10	7.29
	16mm x 3/4"	16	3079789	5	7.42
	20mm x 1/2"	20	3079790	10	8.28
	20mm x 3/4"	20	3079791	10	10.71
	25mm x 3/4"	25	3079793	10	14.15
	32mm x 1"	32	3079796	5	23.91
	40mm x 1 1/4"	40	3079797	3	35.29
	End Cap				
		16	3079859	10	6.21
		20	3079860	10	6.89
		25	3079861	5	7.89

Wavin Tigris M5













Metal-body Press-fit plumbing system

Description	Nom dia mm	Cat no	Pack qty	Price £ per piece	
Couplers					
 Straight Coupler	16	4063971	10	7.34	
	20	4063972	10	9.17	
	25	4063974	5	14.51	
	32	4064166	5	22.00	
	40	4064167	5	51.03	
 Reducing Coupler	20 x 16mm	20	4064182	10	8.69
	25 x 20mm	25	4064185	5	12.60
	32 x 25mm	32	4064190	5	18.50
	40 x 32mm	40	4064193	5	42.89
	Elbows				
 Elbow 90°	16	4064199	10	8.05	
	20	4064200	10	10.84	
	25	4064202	5	18.02	
	32	4064204	5	27.11	
	40	4064205	5	83.24	
 Elbow 90° – single male BSP thread	16mm x 1/2"	16	4066001	10	10.73
	20mm x 1/2"	20	4066003	10	11.64
	20mm x 3/4"	20	4066004	10	15.64
	25mm x 3/4"	25	4066005	5	21.09
	32mm x 1"	32	4066007	5	34.09
 Elbow 90° – single female BSP thread	16mm x 1/2"	16	4066009	10	11.09
	20mm x 1/2"	20	4066011	10	12.09
	20mm x 3/4"	20	4066012	10	16.36
	25mm x 3/4"	25	4066013	5	22.64
	32mm x 1"	32	4066015	5	34.55
Tees					
 Equal Tee	16	4064323	10	11.40	
	20	4064324	10	16.58	
	25	4064326	5	25.51	
	32	4064328	5	38.99	
	40	4064329	5	42.89	
 Branch Reduced Tee	20x16x20mm	20	4064354	10	16.82
	25x16x25mm	25	4064361	5	24.24
	32x16x32mm	32	4064371	5	36.20
 One Sided Female Thread Tee	25mm x 3/4" x 25mm	25	4066095	5	36.00
	32mm x 1" x 32mm	32	4066097	5	57.00
	40mm x 1" x 40mm	40	4066099	5	102.55



	Description	Nom dia mm	Cat no	Pack qty	Price £ per piece
Connectors					
	Connector – single male BSP thread				
	16mm x 1/2"	16	4066041	5	7.10
	16mm x 3/8"	16	4064262	10	7.87
	16mm x 3/4"	16	4066042	10	8.64
	20mm x 1/2"	20	4066043	10	10.91
	20mm x 3/4"	20	4066044	10	14.09
	20mm x 1"	20	4066045	10	13.78
	25mm x 3/4"	25	4066046	5	16.18
	25mm x 1"	25	4064271	5	19.21
	32mm x 1"	32	4064273	5	19.77
	32mm x 1 1/4"	32	4064274	5	34.44
	40mm x 1 1/4"	40	4064276	5	38.99
	Connector – single female BSP thread				
	16mm x 1/2"	16	4066028	10	8.64
	16mm x 3/4"	16	4066029	10	17.27
	20mm x 1/2"	20	4066030	10	10.27
	20mm x 3/4"	20	4066031	5	14.36
	25mm x 3/4"	25	4066033	5	16.55
	25mm x 1"	25	4066034	5	24.91
	32mm x 1"	32	4066035	5	30.64
	Tap Connector – female BSP thread				
	16mm x 1/2"	16	4066072	10	8.64
	16mm x 3/4"	16	4066074	10	8.64
	20mm x 3/4"	20	4066076	10	9.59
	25mm x 3/4"	25	4066078	5	33.27
	25mm x 1"	25	4066079	5	20.53
	32mm x 1 1/4"	32	4066082	5	29.85
	40mm x 1 1/2"	40	4064315	3	39.74
	Tap connector elbows 90° – female BSP thread				
	16mm x 1/2" DRL	16	4066067	1	19.61
	20mm x 1/2" DRL	20	4066068	10	20.00
	Wall Flange				
	16mm x 1/2"	16	4066133	10	13.99
	Elbow 90° – Radiator Connector				
	16 x 15mm – 175mm long	16	4064235	10	22.26
	16 x 15mm – 300mm long	16	4064239	10	28.06

Wavin Tigris M5

Metal-body Press-fit plumbing system

Description	Nom dia mm	Cat no	Pack qty	Price £ per piece
Manifolds				
 Two Port Valved Manifold 3/4" with valves x2 ports 1/2"		4026692	2	30.50
 Three Port Valved Manifold 3/4" with valves x3 ports 1/2"		4026693	2	43.00
 Four Port Valved Manifold 3/4" with valves x4 ports 1/2"		4026694	2	59.60
 Manifold Adaptor 16 x 1/2"	16	4026699	10	6.00
 Two Port Manifold 3/4" x2 ports 1/2"		4026689	2	26.00
 Three Port Manifold 3/4" x3 ports 1/2"		4026690	2	34.00
 Four Port Manifold 3/4" x4 ports 1/2"		4026691	2	47.00
Manifold End Caps				
 3/4" BSP Female End Cap		HX97 GY•	5	4.46
 3/4" BSP Male End Cap		HX98 GY•	5	5.17
Manifold Bracket – Pair				
 for HX92T/15, HX93T/15 and HX94T/15		HX95A GR•	5	29.31
Accessories				
 Transition Fitting to Copper 16 x 15mm	16	4065978	5	11.16
20 x 15mm	20	4065979	5	12.03
20 x 22mm	20	4065981	5	15.31
25 x 22mm	25	4065982	5	22.36
25 x 28mm	25	4065983	5	24.95
32 x 28mm	32	4067485	5	22.00
 Pressure Stopper	16	4013571	1	32.54
	20	4013572	1	32.54
	25	4013573	1	32.54

• PG9 discount applies.

	Description	Nom dia mm	Cat no	Pack qty	Price £ per piece
	Adaptor Fitting to Hep ₂ O				
	16 x 10mm	16	4064278	10	8.11
	16 x 15mm	16	4064277	10	8.52
	20 x 10mm	20	4064279	10	10.44
	20 x 22mm	20	4064280	10	15.24
	25 x 22mm	25	4064281	10	17.72
	25 x 28mm	25	4064282	10	23.33
	32 x 28mm	32	4064283	10	25.30
	Compression Adaptor				
	16mm x 1/2"	16	4055036	10	6.20



Wavin Tigris K1

Press-fit plumbing system

Description	Nom dia mm	Cat no	Pack qty	Price £ per piece
Pipe				
 Pipe – Straight Lengths				
50mm x 4.5mm x 5m	50	3004372	5	179.53
63mm x 6.0mm x 5m	63	3028271	3	292.87
75mm x 7.5mm x 5m	75	3053972	1	381.02
Couplers				
 Straight Coupler				
	50	3027832	2	34.43
	63	3027847	2	90.82
	75	3065639	2	115.46
 Reducing Coupler				
50 x 32mm	50	3027833	2	34.95
50 x 40mm	50	3027834	2	38.49
63 x 40mm	63	3027852	2	87.86
63 x 50mm	63	3027850	2	92.27
75 x 50mm	75	3065641	2	106.10
75 x 63mm	75	3065640	2	109.13
Elbows				
 Elbow 45°				
	50	3024668	2	49.82
	63	3027849	2	112.87
	75	3065642	2	122.97
 Elbow 90°				
	50	3024667	2	45.54
	63	3027848	2	102.63
	75	3065643	2	125.13
Tees				
 Equal Tee				
	50	3027829	2	65.17
	63	3027853	2	122.98
	75	3065644	2	172.96
 Branch Reduced Tee				
50 x 25 x 50mm	50	3027830	2	47.57
50 x 32 x 50mm	50	3027842	2	49.97
50 x 40 x 50mm	50	3027831	2	53.61
63 x 25 x 50mm	63	3027856	2	83.61
63 x 32 x 63mm	63	3027855	2	92.85
63 x 40 x 63mm	63	3027854	2	110.34
75 x 32 x 75mm	75	3065647	2	117.84
75 x 40 x 75mm	75	3065646	2	133.04
75 x 50 x 75mm	75	3065645	2	138.10
Connector				
 Connector – single male BSP thread				
50mm x 1 1/2"	50	3027837	2	39.98













Wavin Tigris M1

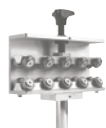









Metal-body Press-fit plumbing system

	Description	Nom dia mm	Cat no	Pack qty	Price £ per piece
Connectors					
	Connector – single male BSP thread				
	63mm x 2"	63	3090826	2	92.19
	75mm x 2½"	75	3090788	1	116.93
	Connector – single female BSP thread				
	50mm x 1½"	50	3090828	3	61.82
	63mm x 2"	63	3090829	2	97.32
	75mm x 2½"	75	4049179	2	158.33

Wavin Tigris

Press-fit plumbing system

Description	Nom dia mm	Cat no	Pack qty	Price £ per piece	
Accessories and Tools					
	Internal Bending Spring	16	4013553	1	38.91
		20	4013559	1	50.04
		25	4013562	1	53.59
	External Bending Spring	16	4023071	1	30.52
		20	4023073	1	33.35
		25	4023075	1	43.81
	Pipe Bending Pliers	16	4043224	1	228.95
	Pipe Bending Tool	20	4043225	1	244.98
	Pipe Bending Pliers 16/20/25mm	–	4023077	1	496.33
	Pipe Straightener 16/20/25mm	–	4013530	1	755.22
	Pipe Cutter 16mm-75mm	–	4053508	1	105.51
	Pipe Cutter with hold function 16/20/25mm	–	4036273	1	103.64
	Replacement Blade for 4036273	–	4037386	1	20.27
	Hand Press Tool 16-20mm	–	4013538	1	263.77
	Note: contains the tool only				
	Hand Tool Insert	16	4013542	1	90.26
		20	4013543	1	90.26
	Cordless Pressing Tool 16mm-40mm	–	4048906	1	2651.05
	Cordless Pressing Tool 16mm-75mm	–	4048907	1	4241.67
	Battery for 4048906	–	4066723	1	231.96

	Description	Nom dia mm	Cat no	Pack qty	Price £ per piece
	Battery for 4048907	–	4066725	1	450.68
	Pressing Jaws – for use with 4048906	16	4046556	1	265.11
		20	4046557	1	265.11
		25	4046558	1	291.62
		32	4046559	1	291.62
		40	4046560	1	424.17
	Pressing Jaws – for use with 4048907	16	4046691	1	304.88
		20	4046694	1	304.88
		25	4046695	1	318.13
		32	4046756	1	318.13
		40	4046758	1	450.68
		50	4046759	1	477.19
		63	4035779	1	702.54
	Pressing Jaws – for use with 4048907 and 4053510	75	4053509	1	503.70
	Pressing Adaptor for 75mm Jaw – for use with 4048907 and 4053509	75	4053510	1	490.45
	Calibration Mandrel	16	4999998	1	88.70
		20	4999999	1	89.88
		25	4023364	1	94.48
		32	4023365	1	101.39
	Calibration Mandrel	40	4031987	1	173.92
		50	4031988	1	169.75
		63	4035780	1	251.42
		75	4053507	1	267.24
	Calibration Mandrel 16/20/25mm	–	3021196	1	107.76
	Handgrip Calibration Mandrel	–	3011162	1	50.13
		–	4036272	1	50.13
	Handgrip Calibration Mandrel	–	4036272	1	50.13
	Calibration Set 16mm-32mm	–	4013541	1	418.27

Introduction to

wavin Hep₂O

Wavin Hep₂O Flexible Push-fit Plumbing is the leading push-fit system with a pedigree of over 40 years and reputation for reliability.

Now Hep₂O has 2 systems to choose from – **Hep₂O Key and Hep₂O Keyless.**

Both systems benefit from:

- In4Sure joint recognition – tells you when the pipe is in.
- Secure demounting with the new HepKey system.
- New, improved SmartSleeve stays captive in the pipe.
- 50 year industry leading guarantee.
- Flexible pipe which comes off the coil straight.

Find out more about Hep₂O Keyless and get your sample here:



Wavin Hep₂O is Kitemarked to Class S of BS 7291, parts 1 and 2 and is manufactured within a Quality Management System which satisfies BS EN ISO 9002.

Wavin Hep₂O is also approved by **WRAS** (certificate 1901900) – deemed safe for use in the supply of drinking water.

Wavin Hep₂O Guarantee

As a result of its rigorous Quality Management programme, **Wavin Hep₂O** carries a 50 year guarantee against defect in materials or manufacturing of all its pipe and fittings.



Prices are for individual items within a pack unless otherwise stated.

Symbols

British Standards Kitemark

Identifies pipe and fittings which are manufactured under the BSI Kitemark Certification Scheme.

Important note: Fittings of all product ranges must be ordered in their pack multiples as illustrated in price list.



Wavin Hep₂O fittings are pre-lubricated, no additional lubrication is required.

DO NOT use any flux, jointing compound or non Wavin Hep₂O lubricant on Wavin Hep₂O fittings.

Email: info@hep2o.co.uk Web: www.hep2o.co.uk  [@hep2o](https://twitter.com/hep2o)

Wavin Hep₂O Push-fit Plumbing

Polybutylene pipe





Description	Nom dia mm	Cat no	Pack qty	Price £ per piece
 Plumbing Pipe				
Coils – Barrier				
Please Note: Order pipe by unit (coil) not by metre				
25m ♡	10	HXX25/10W	1	72.46
50m ♡	10	HXX50/10W	1	142.74
100m ♡	10	HXX100/10W	1	281.19
10m ♡	15	HXX10/15W	1	34.12
25m ♡	15	HXX25/15W	1	85.24
50m ♡	15	HXX50/15W	1	168.70
80m ♡	15	HXX80/15W	1	269.92
100m ♡	15	HXX100/15W	1	332.19
120m ♡	15	HXX120/15W	1	398.64
10m ♡	22	HXX10/22W	1	66.58
25m ♡	22	HXX25/22W	1	166.40
50m ♡	22	HXX50/22W	1	329.48
10m ♡	28	HXX10/28W	1	89.75
25m ♡	28	HXX25/28W	1	224.37
50m ♡	28	HXX50/28W	1	446.61
 Straight Lengths – Barrier				
3m ♡	15	HXX03/15W	10	10.69
3m ♡	22	HXX03/22W	10	20.89
3m ♡	28	HXX03/28W	10	28.65
6m ♡	15	HXX06/15W	40	22.04
6m ♡	22	HXX06/22W	20	43.25
6m ♡	28	HXX06/28W	12	58.98
 Pipe in Pipe System				
Coil of Hep ₂ O Barrier Pipe in Blue or Red Conduit				
Please Note: Order pipe by unit (coil) not by metre				
50m ♡	10	HXXC5010 BU	1	296.46
50m ♡	10	HXXC5010 RD	1	296.46
50m ♡	15	HXXC5015 BU	1	340.88
50m ♡	15	HXXC5015 RD	1	340.88
50m ♡	22	HXXC5022 BU	1	524.35
50m ♡	22	HXXC5022 RD	1	524.35
25m ♡	28	HXXC2528 BU	1	431.68
25m ♡	28	HXXC2528 RD	1	431.68

Important Note:

Order pipe by unit (length) not by metre.
Cut lengths only available as pack quantities.

Wavin Hep₂O Push-fit Plumbing

Demountable fittings

Description		Nom dia mm	Cat no	Pack qty	Price £ per piece
	Straight Connector				
	♥ Key	10	HD1/10W	10	5.45
	♥ Key	15	HD1/15W	10	3.26
	♥ Key	22	HD1/22W	10	4.59
	♥ Key	28	HD1/28W	5	13.22
	♥ Keyless	10	KL1-10	10	5.45
	♥ Keyless	15	KL1-15	10	3.26
	♥ Keyless	22	KL1-22	10	4.59
	♥ Keyless	28	KL1-28	5	13.22
	Elbow 90°				
	♥ Key	10	HD5/10W	10	6.18
	♥ Key	15	HD5/15W	10	3.96
	♥ Key	22	HD5/22W	10	5.81
	♥ Key	28	HD5/28W	5	15.82
	♥ Keyless	10	KL5-10	10	6.18
	♥ Keyless	15	KL5-15	10	3.96
	♥ Keyless	22	KL5-22	10	5.81
	♥ Keyless	28	KL5-28	5	15.82
	Equal Tee				
	♥ Key	10	HD10/10W	10	7.63
	♥ Key	15	HD10/15W	10	5.57
	♥ Key	22	HD10/22W	10	7.63
	♥ Key	28	HD10/28W	5	21.83
	♥ Keyless	10	KL10-10	10	7.63
	♥ Keyless	15	KL10-15	10	5.57
	♥ Keyless	22	KL10-22	10	7.63
	♥ Keyless	28	KL10-28	5	21.83
	Demountable Stop-End				
	♥ Key	10	HD62/10W	10	4.84
	♥ Key	15	HD62/15W	10	4.33
	♥ Key	22	HD62/22W	10	5.45
	♥ Key	28	HD62/28W	5	9.08
	♥ Keyless	10	KL62-10	10	4.84
	♥ Keyless	15	KL62-15	10	4.33
	♥ Keyless	22	KL62-22	10	5.45
	♥ Keyless	28	KL62-28	5	9.08
	SmartSleeve Pipe Support				
	Key / Keyless	10	HX60/10W	20	0.77
	Key / Keyless	15	HX60/15W	50	0.78
	Key / Keyless	22	HX60/22W	50	1.02
	Key / Keyless	28	HX60/28W	20	1.51
	Spigot Elbow 90°				
	Single Socket				
	♥ Key	10	HD4/10W	5	6.18
	♥ Key	15	HD4/15W	5	4.17
	♥ Key	15x10	HD4A/15W	5	6.18
	♥ Key	22	HD4/22W	5	6.18

NEW – Keyless fittings are highlighted in blue + BOLD Cat Nos.

Important Note:

All fittings are pre-lubricated - no additional lubrication required.
Hep₂O fittings are fully compatible with Hep₂O and copper pipe.

Description		Nom dia mm	Cat no	Pack qty	Price £ per piece
Spigot Elbow 90°					
Single Socket					
	♥ Keyless	10	KL4-10	5	6.18
	♥ Keyless	15	KL4-15	5	4.17
	♥ Keyless	15x10	KL4A-15	5	6.18
	♥ Keyless	22	KL4-22	5	6.18
Socket Reducer					
	15 x 10mm ♥ Key	15	HD2/15W	10	5.65
	22 x 15mm ♥ Key	22	HD2/22W	10	4.37
	28 x 22mm ♥ Key	28	HD2/28W	5	10.59
	15 x 10mm ♥ Keyless	10	KL2-15	10	5.65
	22 x 15mm ♥ Keyless	22	KL2-22	10	4.37
	28 x 22mm ♥ Keyless	28	KL2-28	5	10.59
Socket/Socket Reducer					
	15 x 10mm ♥ Key	15	HD3B/15W	10	10.27
	22 x 15mm ♥ Key	22	HD3B/22W	10	8.95
	22 x 10mm ♥ Key	22	HD3C/22W	10	10.27
	15 x 10mm ♥ Keyless	10	KL3B-15	10	10.27
	22 x 15mm ♥ Keyless	22	KL3B-22	10	8.95
	22 x 10mm ♥ Keyless	22	KL3C-22	10	10.27
Obtuse Bend 135° Single Socket					
	♥ Key	10	HD8/10W	5	6.67
	♥ Key	15	HD8/15W	5	4.63
	♥ Key	22	HD8/22W	5	6.67
	♥ Keyless	10	KL8-10	5	6.67
	♥ Keyless	15	KL8-15	5	4.63
	♥ Keyless	22	KL8-22	5	6.67
End Reduced Tee					
	22 x 15 x 22mm ♥ Key	22	HD12/22W	5	8.08
	28 x 22 x 28mm ♥ Key	28	HD12/28W	5	21.83
	22 x 15 x 22mm ♥ Keyless	22	KL12-22	5	8.08
	28 x 22 x 28mm ♥ Keyless	28	KL12-28	5	21.83
Double End Reduced Tee					
	10 x 10 x 15mm ♥ Key	15	HD18/15W	5	8.08
	10 x 10 x 22mm ♥ Key	22	HD18A/22W	5	8.54
	15 x 15 x 22mm ♥ Key	22	HD18/22W	5	8.08
	22 x 22 x 28mm ♥ Key	28	HD18/28W	5	21.83
	10 x 10 x 15mm ♥ Keyless	15	KL18-15	5	8.08
	15 x 15 x 22mm ♥ Keyless	22	KL18-22	5	8.08
	22 x 22 x 28mm ♥ Keyless	28	KL18-28	5	21.83





NEW – Keyless fittings are highlighted in blue + **BOLD** Cat Nos.

Wavin Hep₂O Push-fit Plumbing

Demountable fittings

Description	Nom dia mm	Cat no	Pack qty	Price £ per piece
 Branch Reduced Tee 15 x 15 x 10mm ♡ Key 22 x 22 x 10mm ♡ Key 22 x 22 x 15mm ♡ Key 28 x 28 x 15mm ♡ Key 28 x 28 x 22mm ♡ Key	15	HD13/15W	5	8.08
	22	HD13A/22W	5	8.08
	22	HD13/22W	5	8.08
	28	HD13A/28W	5	21.83
	28	HD13/28W	5	21.83
 15 x 15 x 10mm ♡ Keyless 22 x 22 x 10mm ♡ Keyless 22 x 22 x 15mm ♡ Keyless 28 x 28 x 15mm ♡ Keyless 28 x 28 x 22mm ♡ Keyless	15	KL13-15	5	8.08
	22	KL13A-22	5	8.08
	22	KL13-22	5	8.08
	28	KL13A-28	5	21.83
	28	KL13-28	5	21.83
 Branch Reduced Tee – Spigot 15 x 15 x 10mm ♡ Key 22 x 22 x 15mm ♡ Key	15	HD15/15W	5	8.08
	22	HD15/22W	5	8.08
 15 x 15 x 10mm ♡ Keyless 22 x 22 x 15mm ♡ Keyless	15	KL15-15	5	8.08
	22	KL15-22	5	8.08
 Branch and One End Reduced Tee 15 x 10 x 10mm ♡ Key 22 x 10 x 10mm ♡ Key 22 x 15 x 15mm ♡ Key 28 x 22 x 22mm ♡ Key	15	HD14/15W	5	8.08
	22	HD14A/22W	5	8.08
	22	HD14/22W	5	8.08
	28	HD14/28W	5	21.83
	 15 x 10 x 10mm ♡ Keyless 22 x 10 x 10mm ♡ Keyless 22 x 15 x 15mm ♡ Keyless 28 x 22 x 22mm ♡ Keyless	15	KL14-15	5
22		KL14A-22	5	8.08
22		KL14-22	5	8.08
28		KL14-28	5	21.83
 Blanking Peg For demountable Hep ₂ O fittings ♡ Key / Keyless ♡ Key / Keyless ♡ Key / Keyless ♡ Key / Keyless	10	HX44/10W	10	1.71
	15	HX44/15W	10	1.99
	22	HX44/22W	10	1.99
	28	HX44/28W	10	2.39
 Tank Connector with BSP tail & backnut (For cold water use only) BSP 1/2" Key BSP 3/4" Key BSP 1" (brass body) Key	15	HX20/15W	5	4.72
	22	HX20/22W	5	5.93
	28	HX20/28W	5	26.56
	 BSP 1/2" Keyless BSP 3/4" Keyless	15	KL20-15	5
22		KL20-22	5	5.93
 BSP 1" (brass body) Keyless	28	KLB20-28HX	5	26.56

NEW – Keyless fittings are highlighted in blue + BOLD Cat Nos.

Description	Nom dia mm	Cat no	Pack qty	Price £ per piece	
 <p>Straight Tap Connector with brass nut and alternative rubber washer</p>	BSP 1/2" ♡ Key	15	HD25A/15W	10	5.67
	BSP 3/4" ♡ Key	15	HD25B/15W	5	6.71
	BSP 3/4" ♡ Key	22	HD25B/22W	5	7.26
	BSP 1/2" ♡ Keyless	15	KL25A-15	10	5.67
	BSP 3/4" ♡ Keyless	15	KL25B-15	5	6.71
	BSP 3/4" ♡ Keyless	22	KL25B-22	5	7.26
	Bent Tap Connector with brass nut and alternative rubber washer				
	BSP 1/2" ♡ Key	15	HD27/15W	5	6.26
	BSP 1/2" ♡ Keyless	28	KL27-15	5	6.26
Hand-Titan™ Tap Connector with rubber washer					
	BSP 1/2" ♡ Key	10	HD26A/10W	5	5.76
	BSP 1/2" ♡ Key	15	HD26A/15W	5	4.79
	BSP 3/4" ♡ Key	15	HD26B/15W	5	5.76
	BSP 3/4" ♡ Key	22	HD26B/22W	5	6.23
	BSP 1/2" ♡ Keyless	10	KL26A-10	5	5.76
	BSP 1/2" ♡ Keyless	15	KL26A-15	5	4.79
	BSP 3/4" ♡ Keyless	15	KL26B-15	5	5.76
	BSP 3/4" ♡ Keyless	22	KL26B-22	5	6.23





NEW – Keyless fittings are highlighted in blue + **BOLD** Cat Nos.

Wavin Hep₂O Push-fit Plumbing

Flexible tap connectors – braided

Description	Nom dia mm	Cat no	Pack qty	Price £ per piece
Hep₂O x BSP Nut with brass nut and rubber washer				
 150mm BSP 1/2" Key	15	HD425A/15W	2	9.48
300mm BSP 1/2" Key	15	HD125A/15W	2	10.01
300mm BSP 3/4" Key	15	HD125B/15W	2	11.85
300mm BSP 3/4" Key	22	HD125B/22W	2	11.85
500mm BSP 1/2" Key	15	HD225A/15W	2	13.72
500mm BSP 3/4" Key	15	HD225B/15W	2	15.50
500mm BSP 3/4" Key	22	HD225B/22W	2	16.48
 150mm BSP 1/2" Keyless	15	KL425A-15	2	9.48
300mm BSP 1/2" Keyless	15	KL125A-15	2	10.01
300mm BSP 3/4" Keyless	15	KL125B-15	2	11.85
300mm BSP 3/4" Keyless	22	KL125B-22	2	11.85
500mm BSP 1/2" Keyless	15	KL225A-15	2	13.72
500mm BSP 3/4" Keyless	15	KL225B-15	2	15.50
500mm BSP 3/4" Keyless	22	KL225B-22	2	16.48
Hep₂O x Hep₂O				
 300mm 15mm x 15mm Key	15	HD125H/15W	2	11.76
300mm 22mm x 22mm Key	22	HD125H/22W	2	14.38
500mm 15mm x 15mm Key	15	HD225H/15W	2	17.23
500mm 22mm x 22mm Key	22	HD225H/22W	2	19.90
 300mm 15mm x 15mm Keyless	15	KL125H-15	2	11.76
300mm 22mm x 22mm Keyless	22	KL125H-22	2	14.38
500mm 15mm x 15mm Keyless	15	KL225H-15	2	17.23
500mm 22mm x 22mm Keyless	22	KL225H-22	2	19.90
Hep₂O x Elbow BSP Nut with brass nut and rubber washer				
 300mm Elbow BSP 1/2" Key	15	HD125D/15W	2	12.70
 300mm Elbow BSP 1/2" Keyless	15	KL125D-15	2	12.70

NEW – Keyless fittings are highlighted in blue + **BOLD** Cat Nos.











Description	Nom dia mm	Cat no	Pack qty	Price £ per piece
 <p>Hep₂O Brass Service Valve x BSP Nut with brass nut and rubber washer 300mm BSP 1/2" Key 500mm BSP 1/2" Key</p>	15	HD125E/15W	2	27.20
	15	HD225E/15W	2	29.76
 <p>300mm BSP 1/2" Keyless 500mm BSP 1/2" Keyless</p>	15	KL125E-15	2	27.20
	15	KL225E-15	2	29.76
 <p>Hep₂O Brass Service Valve (Handle) x BSP Nut with brass nut and rubber washer 300mm BSP 1/2" Key</p>	15	HD125EH/15W	2	27.20
	15	KL125EH-15	2	27.20
 <p>Hep₂O x Monobloc Mixers 300mm 15mm x M10 Key 300mm 15mm x M12 Key</p>	15	HD125F/15W •	Pair	17.91
	15	HD125G/15W •	Pair	17.91
 <p>300mm 15mm x M10 Keyless 300mm 15mm x M12 Keyless</p>	15	KL125F-15 •	Pair	17.91
	15	KL125G-15 •	Pair	17.91

• Sold and priced as a pair.











NEW – Keyless fittings are highlighted in blue + **BOLD** Cat Nos.

Wavin Hep₂O Push-fit Plumbing

Auxiliary fittings

	Description	Nom dia mm	Cat no	Pack qty	Price £ per piece
	Adaptor Male BSP/Hep ₂ O socket DZR Brass				
	BSP 1/2" ♡ Key	10	HX29/10W	10	9.32
	BSP 1/2" ♡ Key	15	HX29/15W	10	9.08
	BSP 3/4" ♡ Key	22	HX29/22W	10	13.04
	BSP 1" ♡ Key	28	HX29/28W	5	24.77
	BSP 1/2" ♡ Keyless	10	KLB29-10	10	9.32
	BSP 1/2" ♡ Keyless	15	KLB29-15	10	9.08
	BSP 3/4" ♡ Keyless	22	KLB29-22	10	13.04
	BSP 1" ♡ Keyless	28	KLB29-28	5	24.77
	Adaptor Female BSP/Hep ₂ O socket DZR Brass				
	BSP 1/2" ♡ Key	10	HX28/10W	10	9.32
	BSP 1/2" ♡ Key	15	HX28/15W	10	9.08
	BSP 3/4" ♡ Key	15	HX24/15W	10	13.04
	BSP 3/4" ♡ Key	22	HX28/22W	10	13.04
	BSP 1/2" ♡ Keyless	10	KLB28-10	10	9.32
	BSP 1/2" ♡ Keyless	15	KLB28-15	10	9.08
	BSP 3/4" ♡ Keyless	15	KLB24-15	10	13.04
	BSP 3/4" ♡ Keyless	22	KLB28-22	10	13.04
	BSP 1" ♡ Keyless	28	KLB28-28	5	25.62
	Adaptor Male BSP/Hep ₂ O spigot DZR Brass				
	BSP 1/2" ♡	15	HX31/15W	10	5.06
	BSP 3/4" ♡	22	HX31/22W	10	8.33
	BSP 1" ♡	28	HX31/28W	5	12.23
	Adaptor Female BSP/Hep ₂ O spigot DZR Brass				
	BSP 1/2" ♡	15	HX30/15W	10	4.95
	BSP 3/4" ♡	22	HX30/22W	10	8.33
	BSP 1" ♡	28	HX30/28W	5	12.23
	Draincock Brass 15mm spigot DZR Brass ♡	15	HX32/15 GY	10	9.08
	Adaptor Converts 1/2" tap connector to 3/4" DZR Brass BSP 1/2"x 3/4" ♡		HX39 GR	10	4.70
	Wall Plate Elbow Hep ₂ O				
	BSP 1/2" ♡ Key	15	HX6/15W	5	14.00
	BSP 3/4" ♡ Key	22	HX6/22W	5	15.22
	BSP 1/2" ♡ Keyless	15	KL6-15	5	14.00
	BSP 3/4" ♡ Keyless	22	KL6-22	5	15.22

NEW – Keyless fittings are highlighted in blue + **BOLD** Cat Nos.

Description	Nom dia mm	Cat no	Pack qty	Price £ per piece
 Ball Valve Plated Brass (suitable for central heating use) 15x15mm Key 22x22mm Key	15	HX22/15W	5	17.92
	22	HX22/22W	5	23.41
 15x15mm Keyless 22x22mm Keyless	15	KLB22-15	5	17.92
	22	KLB22-22	5	23.41
 Gate Valve DZR Brass (suitable for central heating use) 15mm Key 22mm Key	15	HX35/15W	5	14.20
	22	HX35/22W	5	20.22
 15mm Keyless 22mm Keyless	15	KLB35-15	5	14.20
	22	KLB35-22	5	20.22
 Stopcock – Cold Water fitted with Hep ₂ O ends 15mm Key 22mm Key	15	HX36/15W	5	25.38
	22	HX36/22W	5	27.29
 Stopcock – Cold Water Hep ₂ O to MDPE Conversion 22mm to 25mm MDPE	22	HX43/22W	5	33.34
 Shut-off Valve With hot/cold indicator insert NB: *SEE USAGE NOTE 15mm Key	15	HX37/15W	5	12.69
 Appliance Valve With hot/cold indicator insert NB: *SEE USAGE NOTE 15mm Key	15	HX38/15W	5	12.06
 Straight Service Valve With hot/cold indicator insert NB: *SEE USAGE NOTE 15mm Key	15	HX18/15W	5	13.96
 Angled Service Valve With hot/cold indicator insert NB: *SEE USAGE NOTE 15mm Key	15	HX19/15W	5	14.60

*For intermittent hot and cold water use up to a maximum of 65°C.
 Not for use with central heating.

NEW – Keyless fittings are highlighted in blue + **BOLD** Cat Nos.

Wavin Hep₂O Push-fit Plumbing

Auxiliary fittings

	Description	Nom dia mm	Cat no	Pack qty	Price £ per piece
	Two Port Manifold 22x15mm ports Closed Spigot ♡ Key	22	HX88/22W	5	10.89
	22x15mm ports Closed Spigot ♡ Keyless	22	KL88-22	5	10.89
	Two Port Manifold 22x15mm ports All socket ♡ Key	22	HX88B/22W	5	11.25
	22x15mm ports All socket ♡ Keyless	22	KL88B-22	5	11.25
	Three Port Manifold 22x15mm ports Closed spigot ♡ Key	22	HX89/22W	5	14.62
	22x15mm ports Closed spigot ♡ Keyless	22	KL89-22	5	14.62
	Three Port Manifold 22x15mm ports All socket ♡ Key	22	HX89B/22W	5	15.16
	22x15mm ports All socket ♡ Keyless	22	KL89B-22	5	15.16
	Two Port Manifold 22x10mm ports All socket ♡ Key	22	HX92B/22W	5	11.91
	22x10mm ports All socket ♡ Keyless	22	KL92B-22	5	11.91
	Four Port Manifold 22x10mm ports All socket ♡ Key	22	HX94B/22W	5	15.16
	22x10mm ports All socket ♡ Keyless	22	KL94B-22	5	15.16

NEW – Keyless fittings are highlighted in blue + BOLD Cat Nos.

	Description	Nom dia mm	Cat no	Pack qty	Price £ per piece
	Two Port Manifold 22x10mm ports Socket and closed spigot ♡ Key	22	HX92/22W	5	10.89
	22x10mm ports Socket and closed spigot ♡ Keyless	22	KL92-22	5	10.89
	Four Port Manifold 22x10mm ports Socket and closed spigot ♡ Key	22	HX94/22W	5	14.62
	22x10mm ports Socket and closed spigot ♡ Keyless	22	KL94-22	5	14.62
	Four Port Manifold 22x10mm ports Socket and closed spigot, on one side ♡ Key	22	HX96/22W	5	16.72
	22x10mm ports Socket and closed spigot, on one side ♡ Keyless	22	KL96-22	5	16.72
	Four Port Manifold 22x10mm ports All socket, on one side ♡ Key	22	HX96B/22W	5	16.72
	22x10mm ports All socket, on one side ♡ Keyless	22	KL96B-22	5	16.72
	One Port Valved Manifold Plated Brass 3/4" BSP Male/female 22mm Hep2O port ♡ Key	22	HX91T/22W	1	30.45
	Plated Brass 3/4" BSP Male/female 22mm Hep2O port ♡ Keyless	22	KLB91T-22	1	30.45
	Two Port Valved Manifold Plated Brass 3/4" BSP Male/female 15mm Hep2O ports ♡ Key	15	HX92T/15W	1	51.14
	Plated Brass 3/4" BSP Male/female 15mm Hep2O ports ♡ Keyless	15	KLB92T-15	1	51.14

NEW – Keyless fittings are highlighted in blue + **BOLD** Cat Nos.

Wavin Hep₂O Push-fit Plumbing

Auxiliary fittings

Description	Nom dia mm	Cat no	Pack qty	Price £ per piece
 <p>Three Port Valved Manifold Plated Brass 3/4" BSP Male/female 15mm Hep₂O ports ♡ Key</p>	15	HX93T/15W	1	75.00
 <p>Plated Brass 3/4" BSP Male/female 15mm Hep₂O ports ♡ Keyless</p>	15	KLB93T-15	1	75.00
 <p>Four Port Valved Manifold Plated Brass 3/4" BSP male/female. 15mm Hep₂O ports ♡ Key</p>	15	HX94T/15W	1	102.40
 <p>Plated Brass 3/4" BSP male/female. 15mm Hep₂O ports ♡ Keyless</p>	15	KLB94T-15	1	102.40
 <p>Manifold End Caps 3/4" BSP Female End Cap 3/4" BSP Male End Cap</p>		HX97 GY HX98 GY	5 5	4.46 5.17
 <p>Manifold Bracket – Pair for HX92T/15, HX93T/15 and HX94T/15</p>		HX95A GR	1	29.31
 <p>Radiator Outlet Back Box Plastic (for stud wall)</p>		HX109 GY	5	4.72
 <p>Radiator Outlet Back Box Metal (for solid wall)</p>		HX110 GY	5	3.95
 <p>Radiator Outlet Cover with Flap For use with HX109 and HX110</p>		HX113 WH	5	10.36
 <p>Back Box Grommet For use with HX110</p>		HX112 GY	50	0.26

NEW – Keyless fittings are highlighted in blue + **BOLD** Cat Nos.



Wavin Hep₂O Push-fit Plumbing

Tools, fixings and accessories





Description	Nom dia mm	Cat no	Pack qty	Price £ per piece
 HepKey Plus Demounting Tool	10	HX79/10W	10	0.49
	15	HX79/15W	10	0.57
	22	HX79/22W	10	0.57
	28	HX79/28W	10	0.64
 HepKey Demounting Tool	10	HX78/10W	10	0.44
	15	HX78/15W	10	0.49
	22	HX78/22W	10	0.49
	28	HX78/28W	10	0.56
 HepTool Demounting Tool 10/28mm 15/22mm	10	HX77/10W	10	2.98
	15	HX77/15W	10	2.44
 Cold Forming Bend Fixture Metal with passivate finish	15	HX75/15 GR	5	3.04
	22	HX75/22 GR	5	4.28
 Pipe Cutter – Scissor Type Standard		HD74 GR	1	25.21
 Pro Cutter		HD75 GR	1	62.14
 Pipe Cutter – Ratchet Type up to 28mm pipe		HD78 GR	1	63.57
 Hep₂O Joint Test Kit Hep ₂ O Joint Test Kit		HX81 GR	1	728.67
 Pipe Clips – Screw	15	HX85/15W	50	0.47
	22	HX85/22W	50	0.47
	28	HX85/28W	50	0.78
 Pipe Clip – Spacers	15	HX86/15W	20	0.35
	22	HX86/22W	20	0.47
 Pipe Clip Cable Type	10	HX65/10W	50	0.29
	15	HX65/15W	50	0.47
	22	HX65/22W	50	0.47
	28	HX65/28W	50	0.57

Wavin Hep₂O Push-fit Plumbing

Tools, fixings and accessories

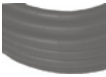
Description	Nom dia mm	Cat no	Pack qty	Price £ per piece
 Hep₂O Silicone Lubricant Spray 400ml aerosol can Hep ₂ O fittings		HX200	1	17.33
 Flat Tap Connector Washers – Rubber	15 22	HX58/15 GY HX58/22 GY	20 20	p/pack 6.66 p/pack 6.66
 Conical Tap Connector Washers – Rubber	15 22	HX57/15 GR HX57/22 GR	20 20	p/pack 6.66 p/pack 6.66

Conduit system

Description	Nom dia mm	Cat no	Pack qty	Price £ per piece
 Conduit Pipe 25.0m 50.0m 25.0m 50.0m	15 15 22 22	HXC25/15 BL HXC50/15 BL HXC25/22 BL HXC50/22 BL	1 1 1 1	52.98 106.05 66.30 131.90
 Conduit Junction Box		HX100 BL	1	8.79
 Conduit Junction Box Lid		HX104 BL	1	2.95
 Conduit Terminal	15	HX101/15W	2	12.24
 Terminal Back Plate		HX103 BL	1	2.44

Introduction to

Wavin Indoor Climate Solutions

Wavin Indoor Climate Solutions (ICS) provides a comprehensive range of solutions to create a healthier and more comfortable indoor environment. We offer a range of compatible products including underfloor heating, mechanical ventilation, heat interface units, and control systems for maximum usability and efficiency.

Wavin Calefa heat interface units provide 4-option bypass control, setting new standards for domestic hot water and heating, delivering on responsiveness, efficiency, and ease of installation.

Wavin Comfia provides a wide range of underfloor heating systems for new and existing floors. Our systems are easy to install and come with marketing leading guarantees.

Wavin Ventiza joins premium quality heat exchangers with extremely low power consumption, providing a range of solutions that matches performance to property size for maximum efficiency.

Wavin Sentio delivers optimum comfort and energy efficient methods to controlling the indoor climate of domestic and commercial buildings with a single control system to operate all Wavin ICS solutions.







Find out more at wavin.co.uk

Wavin Indoor Climate Solutions



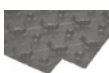





UFH – Polybutylene pipe

Description	Nom dia mm	Cat no	Pack qty	Price £ per piece
 Polybutylene Pipe Coils Please Note: Order pipe by unit (coil) not by metre				
50m	12	12CS050	1	70.62
80m	12	12CS080	1	111.30
100m	12	12CS100	1	139.13
50m	16	16CS050	1	82.88
80m	16	16CS080	1	136.26
100m	16	16CS100	1	169.31
120m	16	16CS120	1	197.01
150m	16	16CS150	1	244.31
200m	16	16CS200	1	338.62
500m	16	16CS500	1	805.20
100m	20	20CS100	1	206.91
120m	20	20CS120	1	264.61
140m	20	20CS140	1	308.72
160m	20	20CS160	1	352.78
180m	20	20CS180	1	396.89
200m	20	20CS200	1	441.00

UFH – Floor fixings and accessories









Description	Nom dia mm	Cat no	Pack qty	Price £ per piece
 Staple System Staples 60mm for 16mm and 20mm Pipe	16/20	30CS301	300	0.07
 Staple Gun for 60mm staples		30CS305	1	302.33
 Clip Rail Universal Clip Rail for 16mm and 20mm pipe	16/20	30CS302	1	2.88
 System Plate 25mm System Plate for 16mm pipe	16	16CS303	18	11.05
18mm System Plate for 12mm pipe	12	12CS303	16	8.68
 System Plate Tack Fastener		30CS306	25	0.36
 Edge Expansion Foam Edge Expansion Foam (25m x 150mm)		30CS304	1	24.85
 Bend Former Cold Formed Metal Bend for 12mm pipe	12	12CS300	5	1.26
for 16mm pipe	16	16CS300	5	1.26
for 20mm pipe	20	20CS300	5	2.52

UFH – Manifolds

	Description	Nom dia mm	Cat no	Pack qty	Price £ per piece
	Composite Manifold Pre-Built Modular Manifolds				
	2 Port		30CS502	1	144.45
	3 Port		30CS503	1	164.28
	4 Port		30CS504	1	192.01
	5 Port		30CS505	1	218.52
	6 Port		30CS506	1	241.11
	7 Port		30CS507	1	268.02
	8 Port		30CS508	1	295.40
	9 Port		30CS509	1	321.28
	10 Port		30CS510	1	348.60
	11 Port		30CS511	1	375.93
	12 Port		30CS512	1	396.20
	Composite Manifold 22mm Isolation Valves Pair	22	30CS513	2	34.15
	Composite Manifold Control Pack A Rated		30CS515	1	251.36
	Composite Manifold Flow Watch Thermostat		30CS516	1	22.09
	Manifold Euroconus Adaptor for 12mm pipe	12	12CS501	2	2.42
	for 16mm pipe	16	16CS501	2	2.75
	for 20mm pipe	20	20CS501	2	3.08
	Composite Manifold 1-Port Module Flow module with indicator ▲	15	30CS517	1	17.89
	Return module ▲	15	30CS518	1	12.75
	Composite Manifold 3-Port Module Flow module with indicator ▲	15	30CS519	1	49.52
	Return module ▲	15	30CS520	1	34.42
	Composite Manifold – Starter Pack ▲		30CS514	1	111.13
	Nipple 3/4" x 3/4"		16CS505	50	3.50

Wavin Indoor Climate Solutions



UFH – Manifolds

Description	Nom dia mm	Cat no	Pack qty	Price £ per piece
Stainless Steel Manifold				
 Stainless Manifold*				
2 port	15	30CS532	1	110.59
3 port	15	30CS533	1	131.27
4 port	15	30CS534	1	153.47
5 port	15	30CS535	1	180.06
6 port	15	30CS536	1	197.84
7 port	15	30CS537	1	218.99
8 port	15	30CS538	1	255.41
9 port	15	30CS539	1	281.25
10 port	15	30CS540	1	306.66
11 port	15	30CS541	1	338.04
12 port	15	30CS542	1	356.35
Stainless Steel Manifold Ancillaries				
 Stainless Steel Isolating Valves 1" Pair	15	30CS530	1	35.25
 Stainless Steel Single Way Kit	15	30CS531	1	67.77
 Thermometer for Ball Valves		30CS543	1	4.11
 Thermometer with Spring		30CS544	1	3.92
 Coupling 1" Female – Female Stainless Pair	15	30CS545	1	25.20
 Auto Airvent with Non-return Stainless	15	30CS546	1	4.21
 Actuator Adaptor Pair		30CS547	1	0.95
 Temperature Pressure Gauge		30CS521	1	17.00

*Each stainless steel manifold requires the correct quantity of actuator adaptors (30CS547) and euroconus adaptors (12CS501, 16CS501 or 20CS501) depending on the actuator size and pipe being used.

Wavin Indoor Climate Solutions

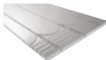
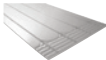
UFH – Panel Systems

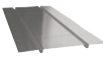
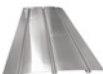



Description	Nom dia mm	Cat no	Pack qty	Price £ per piece
UFH – Panel Systems				
 Low-Build 25 for 16mm pipe	16	16CS309	10	24.55
 Low-Build 18 for 12mm pipe, foil-faced for 12mm pipe, glass-fibre mesh	12	12CS310	10	31.23
	12	12CS311	10	31.23
 Low-Build Panel Adhesive 14kg		12CS319	1	247.92
UFH – Diffuser Plates				
 Double Diffuser Plate for 16mm pipe for 20mm pipe	16	16CS307	10	12.22
	20	20CS307	10	12.22
 Triple Diffuser Plate for 16mm pipe	16	16CS308	10	15.46

Wavin Indoor Climate Solutions

UFH – Control Systems





	Description	Nom dia mm	Cat no	Pack qty	Price £ per piece
Sentio Controls					
	Sentio Thermostats Wired		35CS400	1	88.62
	Wireless		35CS403	1	91.39
	Wireless with Infra-Red Floor Sensor		35CS402	1	116.13
	Sentio Sensors Wired		35CS401	1	60.29
	Wireless		35CS404	1	69.83
	Sensor Probe Remote/Floor Sensor Probe		35CS490	1	10.55
	Sensor Probe Cover		35CS489	1	10.55
	Sentio Control Centre 8 Zone Control Centre		35CS405	1	209.45
	Sentio Extension Unit 8 Way Extension Unit for use with 35CS405		35CS406	1	79.34
	Sentio Touch Screen LCD Touch Screen		35CS407	1	128.89
	Sentio Thermostat Frame		35CS408	1	6.53
	Sentio Smart Radiator Thermostat including M28 and M30 adaptors		35CS411	1	89.62
Sentio Ancillaries					
	Sentio VFR Extension Unit		35CS409	1	91.39
	Sentio Strap On Pipe Sensor		35CS410	1	15.69
	Sentio Actuator Adaptor		35CS412	1	3.13

UFH – Control Systems

	Description	Nom dia mm	Cat no	Pack qty	Price £ per piece
	Sentio Wired Outdoor Sensor		35CS413	1	55.42
	Sentio USB Converter Cable		35CS414	1	75.16
	24V Actuator for use with Sentio controls		35CS499	1	20.41
	230V Actuator for use with Neo controls		35CS498	1	20.41









Wavin Indoor Climate Solutions

UFH – Heat Interface Units

	Description	Nom dia mm	Cat no	Pack qty	Price £ per piece
	Calefa Calefa V – Heat Interface Unit including heat meter		40CS600	1	2468.41
	Calefa V – 40/40H		40CS603	1	2090.74
	Calefa Flushing Bypass		40CS601	1	143.35
	Calefa Frame Top Entry Kit 4 Pipe		40CS602	1	446.93

Wavin Indoor Climate Solutions

MVHR Units

	Description	Nom dia mm	Cat no	Pack qty	Price £ per piece
	Ventiza Ventiza HRU200 – Vertical 60l/s Unit Left Handed		HRU220VL	1	1479.98
	Right Handed		HRU220VR	1	1479.98
	Ventiza HRU360 – Vertical 100l/s Unit Left Handed		HRU360VL	1	1638.90
	Right Handed		HRU360VR	1	1638.90
	Ventiza HRU400 – Vertical 110l/s Unit Left Handed		HRU400VL	1	1727.43
	Ventiza HRU300 – Horizontal Ceiling Unit for 150mm diameter ducting		HRU300H1	1	1872.63
	for 204mm x 60mm ducting		HRU300H2	1	1872.63
	Ventiza Ventilation Controller		VCONT001	1	179.33
	Ventiza HRU220 Replacement Filter Set G4 Grade		HRU220FILG4	1	44.74
	F7 Grade		HRU220FILF7	1	174.79
	Ventiza HRU360 Replacement Filter Set G4 Grade		HRU360FILG4	1	48.58
	F7 Grade		HRU360FILF7	1	151.71
	Ventiza HRU400 Replacement Filter Set G4 Grade	HRU400FILG4	1	145.00	
	F7 Grade	HRU400FILF7	1	251.85	

Numerical index

Cat no	Price £ per piece	Page no	Cat no	Price £ per piece	Page no	Cat no	Price £ per piece	Page no
OT003B	23.78	5	OT033B	13.59	7	OT086N	60.37	6
OT003G	23.78	5	OT033G	13.59	7	OT086W	60.37	6
OT003N	23.78	5	OT033N	13.59	7	OT088AG	112.67	6
OT003W	23.78	5	OT033W	13.59	7	OT088B	112.67	6
OT004B	31.10	5	OT034AG	9.47	7	OT088G	112.67	6
OT004G	31.10	5	OT034B	9.47	7	OT088N	112.67	6
OT004N	31.10	5	OT034G	9.47	7	OT088W	112.67	6
OT004W	31.10	5	OT034N	9.47	7	OT092B	28.56	7
OT005B	12.43	4	OT034W	9.47	7	OT116B	3.07	9
OT005G	12.43	4	OT035AG	47.20	8	OT116G	3.07	9
OT005N	12.43	4	OT035B	47.20	8	OT116N	3.07	9
OT005W	12.43	4	OT035G	47.20	8	OT116W	3.07	9
OT007B	30.92	4	OT035N	47.20	8	OT143B	31.56	7
OT007G	30.92	4	OT035W	47.20	8	OT147G	36.02	22
OT007N	30.92	4	OT037AG	15.71	8	OT147G	36.02	20
OT007W	30.92	4	OT037B	15.71	8	OT147G	36.02	18
OT008B	27.88	5	OT037G	15.71	8	OT147G	36.02	16
OT009B	16.61	4	OT037N	15.71	8	OT147G	36.02	11
OT009G	16.61	4	OT037W	15.71	8	OT147G	36.02	6
OT009N	16.61	4	OT038AG	11.10	7	OT148G	33.26	6
OT009W	16.61	4	OT038B	11.10	7	OT148G	33.26	11
OT010B	7.96	4	OT038G	11.10	7	OT148G	33.26	16
OT010G	7.96	4	OT038N	11.10	7	OT148G	33.26	18
OT010N	7.96	4	OT038W	11.10	7	OT148G	33.26	20
OT010W	7.96	4	OT044B	6.74	21	OT148G	33.26	22
OT011B	10.25	5	OT044B	6.74	19	OT149B	30.22	12
OT011G	10.25	5	OT044B	6.74	17	OT149B	30.22	7
OT011N	10.25	5	OT044B	6.74	15	OT161AG	27.98	8
OT011W	10.25	5	OT044B	6.74	10	OT161B	27.98	8
OT014B	47.75	5	OT044B	6.74	4	OT161G	27.98	8
OT015B	47.75	5	OT045B	15.56	4	OT161N	27.98	8
OT016B	32.78	5	OT045B	15.56	10	OT161W	27.98	8
OT017B	73.13	5	OT045B	15.56	17	OT201B	99.40	13
OT019B	5.48	4	OT045B	15.56	19	OT201B	99.40	9
OT019G	5.48	4	OT060B	4.21	9	OT201W	99.40	9
OT019N	5.48	4	OT061B	4.21	9	OT201W	99.40	13
OT019W	5.48	4	OT064G	4.21	9	OT245B	30.70	6
OT024AG	11.58	7	OT072B	38.49	4	OT246B	30.70	6
OT024B	11.58	7	OT072G	38.49	4	OT274AG	85.20	8
OT024G	11.58	7	OT072N	38.49	4	OT274B	85.20	8
OT024N	11.58	7	OT072W	38.49	4	OT274G	85.20	8
OT024W	11.58	7	OT074B	76.55	4	OT274N	85.20	8
OT025AG	14.51	8	OT074G	76.55	4	OT274W	85.20	8
OT025B	14.51	8	OT074N	76.55	4	OT332AG	63.38	8
OT025G	14.51	8	OT074W	76.55	4	OT332B	63.38	8
OT025N	14.51	8	OT082B	43.16	6	OT332G	63.38	8
OT025W	14.51	8	OT082G	43.16	6	OT332N	63.38	8
OT026AG	18.04	8	OT082N	43.16	6	OT332W	63.38	8
OT026B	18.04	8	OT084AG	86.27	6	OT624B	25.13	4
OT026G	18.04	8	OT084B	86.27	6	OT624G	25.13	4
OT026N	18.04	8	OT084G	86.27	6	OT624N	25.13	4
OT026W	18.04	8	OT084N	86.27	6	OT624W	25.13	4
OT027B	22.51	8	OT084W	86.27	6	OT625B	38.31	4
OT030B	5.29	7	OT086AG	60.37	6	OT745B	30.19	6
OT031B	4.51	7	OT086B	60.37	6	OT746B	32.67	6
OT033AG	13.59	7	OT086G	60.37	6	OT914B	23.53	5

Cat no	Price £ per piece	Page no	Cat no	Price £ per piece	Page no	Cat no	Price £ per piece	Page no
OT914G	23.53	5	1E346B	8.10	52	2S356W	26.78	27
OT914N	23.53	5	1E346W	8.10	44	2S356W	26.78	64
OT914W	23.53	5	1E346W	8.10	52	2S356W*	26.78	59
OT985B	16.74	21	1O158W	5.41	53	2S360G	19.85	29
OT985B	16.74	19	1O159W	6.42	53	2S398B	13.99	28
OT985B	16.74	18	2CS802SE	22.20	67	2S398E	13.99	63
OT985B	16.74	16	2CS804SE	13.37	67	2S398G	13.99	28
OT985B	16.74	11	2CS805SE	13.37	67	2S398W	13.99	28
OT985B	16.74	5	2CS812SE	15.60	67	2S399B	13.99	29
OT986B	25.14	5	2CS813SE	22.20	67	2S399E	13.99	63
OT986B	25.14	11	2CS814SE	13.01	67	2S399G	13.99	29
OT986B	25.14	16	2CS815SE	12.01	67	2S399W	13.99	29
OT986B	25.14	18	2CS816SE	14.33	67	2S402B	18.04	29
OT986B	25.14	19	2M073B	72.65	68	2S402E	18.04	63
OT986B	25.14	21	2M073E	72.65	68	2S402G	18.04	29
OT988B	13.96	5	2M073W	72.65	68	2S402W	18.04	29
OT988B	13.96	11	2M081E	3.75	68	2S403B	14.33	35
OT988B	13.96	16	2M104E	14.68	68	2S403E	14.33	63
OT988B	13.96	18	2M104W	14.68	68	2S403G	14.33	35
OT988B	13.96	19	2M124E	28.30	68	2S403W	14.33	35
OT988B	13.96	21	2M124W	28.30	68	2S498B	15.52	50
OT989B	18.74	5	2M160B	22.54	68	2S499B	15.52	50
OT989B	18.74	11	2M160E	22.54	68	2S503B	16.20	50
OT989B	18.74	16	2M160W	22.54	68	2V414G	213.22	50
OT989B	18.74	18	2M161B	22.02	68	2V418G	34.72	50
OT989B	18.74	19	2M161E	22.02	68	2V502G	186.67	50
OT989B	18.74	21	2M161W	22.02	68	2W073G	36.09	45
OT999B	129.73	5	2M163B	18.92	69	2W073W	36.09	45
OT999G	129.73	5	2M163E	18.92	69	2W081G	2.69	45
OT999N	129.73	5	2M163W	18.92	69	2W081W	2.69	45
OT999W	129.73	5	2M190B	30.44	69	2W086G	9.43	47
1C074W	16.25	52	2M190E	30.44	69	2W086W	9.43	47
1C104W	5.41	52	2M190W	30.44	69	2W088G	8.43	47
1C139W	9.84	52	2M260B	24.85	69	2W088W	8.43	47
1C160W	5.25	52	2M260E	24.85	69	2W102G	9.82	46
1C163W	6.42	52	2M260W	24.85	69	2W102G	9.82	43
1C190W	7.54	52	2M292B	18.10	69	2W102G*	9.82	74
1C344W	8.10	52	2M292E	18.10	69	2W105G	9.66	45
1C344W	8.10	47	2M292W	18.10	69	2W105W	9.66	45
1C346W	8.10	47	2M456B	12.59	69	2W160G	9.66	45
1C346W	8.10	52	2M456E	12.59	69	2W160W	9.66	45
1E073W	13.72	52	2M456W	12.59	69	2W163G	10.21	45
1E082W	1.96	52	2M458B	12.59	69	2W163W	10.21	45
1E104W	5.62	52	2M458E	12.59	69	2W190G	9.43	46
1E129W	8.75	52	2M458W	12.59	69	2W190W	9.43	46
1E139W	9.77	52	2S298B	13.01	35	2W260W	9.43	46
1E156W	8.14	53	2S298E	13.01	63	2W292G	9.66	46
1E160W	5.82	52	2S298G	13.01	35	2W292W	9.66	46
1E163W	6.67	52	2S298W	13.01	35	2Z073B	43.27	41
1E166W	6.67	52	2S299B	12.01	35	2Z073W	43.27	41
1E190W	7.19	52	2S299E	12.01	63	2Z074G	57.69	41
1E344B	8.10	44	2S299G	12.01	35	2Z081B	3.75	41
1E344B	8.10	52	2S299W	12.01	35	2Z081G	3.75	41
1E344W	8.10	44	2S355W	16.27	64	2Z081W	3.75	41
1E344W	8.10	52	2S355W	16.27	27	2Z086B	8.86	44
1E346B	8.10	44	2S355W*	16.27	59	2Z086G	8.86	44

Numerical index

Cat no	Price £ per piece	Page no	Cat no	Price £ per piece	Page no	Cat no	Price £ per piece	Page no
2Z086W	8.86	44	3S190G	108.28	27	4S043B	132.02	23
2Z088B	9.07	44	3S210G	108.28	28	4S043E	132.02	61
2Z088G	9.07	44	3S274B	119.55	30	4S043G	132.02	23
2Z088W	9.07	44	3S274G	119.55	30	4S043W	132.02	23
2Z104B	10.56	41	3S288B	79.61	39	4S044B	178.11	23
2Z104G	10.56	41	3S292B	59.18	36	4S044E	182.51	61
2Z104W	10.56	41	3S292B	59.18	31	4S044G	178.11	23
2Z124W	18.34	41	3S292G	59.18	31	4S044W	178.11	23
2Z124W*	18.34	74	3S292G	59.18	36	4S050G	119.07	23
2Z128W	18.78	44	3S300B	24.58	39	4S073B	127.01	32
2Z160B	12.69	41	3S300G	26.01	39	4S073B	127.01	23
2Z160G	12.69	41	3S302B	21.54	39	4S073E	127.01	61
2Z160W	12.69	41	3S302G	21.54	39	4S073G	127.01	23
2Z161B	13.44	42	3S319B	28.32	30	4S073G	127.01	32
2Z161G	13.44	42	3S319G	28.32	30	4S073W	127.01	23
2Z161W	13.44	42	3S414G	208.41	39	4S073W	127.01	32
2Z163B	13.76	42	3S435G	63.39	26	4S074B	169.32	23
2Z163G	13.76	42	3S440B	74.79	27	4S074B	169.32	32
2Z163W	13.76	42	3S440G	74.79	27	4S074E	169.32	61
2Z190B	18.53	42	3S530B	166.67	39	4S074G	169.32	23
2Z190G	18.53	42	3S649B	58.07	29	4S074G	169.32	32
2Z190W	18.53	42	3S649G	58.07	29	4S074W	169.32	23
2Z210B	24.00	43	4A830W	8.94	50	4S074W	169.32	32
2Z210G	24.00	43	4CS588SE	25.46	67	4S082B	11.69	32
2Z210W	24.00	43	4CS832SE	246.49	67	4S082B	11.69	23
2Z230W	43.88	43	4CS834SE	246.49	67	4S082E	11.69	61
2Z260B	11.51	42	4CS895SE	102.49	67	4S082G	11.69	23
2Z260G	11.51	42	4M073B	43.28	68	4S082G	11.69	32
2Z260W	11.51	42	4M073E	43.28	68	4S082W	11.69	23
2Z292B	13.60	43	4M073W	43.28	68	4S082W	11.69	32
2Z292G	13.60	43	4M081E	1.81	68	4S083B	15.58	32
2Z292W	13.60	43	4M104B	7.18	68	4S083B	15.58	23
2Z347G	11.80	44	4M104E	7.18	68	4S083E	15.58	61
2Z349G	11.18	44	4M104W	7.18	68	4S083G	15.58	23
2Z359G	21.44	42	4M124E	15.16	68	4S083G	15.58	32
2Z359G*	21.44	74	4M124W	15.16	68	4S083W	15.58	23
3S043B	152.09	23	4M160B	10.73	68	4S083W	15.58	32
3S043G	152.09	23	4M160E	10.73	68	4S084	33.75	23
3S074G	198.38	23	4M160W	10.73	68	4S084	33.75	32
3S082B	13.67	23	4M161B	13.12	68	4S085	225.70	32
3S082G	13.67	23	4M161E	13.12	68	4S085	225.70	24
3S083B	18.18	23	4M161W	13.12	68	4S086	109.66	32
3S083G	18.18	23	4M163B	9.96	69	4S086	109.66	24
3S094B	62.78	25	4M163E	9.96	69	4S095B	54.18	33
3S094G	62.78	25	4M163W	9.96	69	4S095B	54.18	25
3S105B	51.39	24	4M190B	17.14	69	4S095E	54.18	61
3S105G	51.39	24	4M190E	17.14	69	4S095G	54.18	25
3S116B	3.56	31	4M190W	17.14	69	4S095G	54.18	33
3S116G	3.56	31	4M260B	13.84	69	4S096B	59.07	25
3S124B	29.96	24	4M260E	13.84	69	4S096E	59.07	61
3S124G	29.96	24	4M260W	13.84	69	4S096G	59.07	25
3S161B	60.83	25	4M292B	10.61	69	4S097G	62.23	25
3S161G	60.83	25	4M292E	10.61	69	4S098G	62.23	25
3S163B	60.83	26	4M292W	10.61	69	4S104B	25.69	24
3S163G	60.83	26	4S042B	100.42	23	4S104B	25.69	32
3S190B	108.28	27	4S042G	100.42	23	4S104E	25.69	61

Cat no	Price £ per piece	Page no	Cat no	Price £ per piece	Page no	Cat no	Price £ per piece	Page no
4S104G	25.69	24	4S190B	99.99	27	4S296G	39.04	36
4S104G	25.69	32	4S190G	99.99	27	4S296W	39.04	31
4S104W	25.69	24	4S190W	99.99	27	4S296W	39.04	36
4S104W	25.69	32	4S195B	129.61	27	4S298	27.16	25
4S105B	55.48	32	4S195G	129.61	27	4S299	31.26	25
4S105B	55.48	24	4S195W	129.61	27	4S300B	22.92	39
4S105E	55.48	61	4S200B	145.04	28	4S300E	24.25	66
4S105G	55.48	24	4S200G	145.04	28	4S300G	22.92	39
4S105G	55.48	32	4S205B	47.81	24	4S300W	22.92	39
4S105W	55.48	24	4S205G	47.81	24	4S302B	16.40	39
4S105W	55.48	32	4S205W	47.81	24	4S302E	16.40	66
4S106G	75.61	24	4S206B	82.17	25	4S302G	16.40	39
4S107E	46.54	61	4S206B	82.17	33	4S302W	16.40	39
4S116B	11.48	31	4S210B	148.64	28	4S303W	124.10	44
4S116G	11.48	31	4S210G	148.64	28	4S303W	124.10	39
4S116W	11.48	31	4S220B	145.04	28	4S303W	124.10	47
4S120W	30.59	37	4S220G	145.04	28	4S304W	280.47	39
4S121W	32.63	37	4S230B	250.05	28	4S306G	182.13	39
4S124B	26.75	33	4S230G	250.05	28	4S308B	200.24	39
4S124B	26.75	24	4S230W	250.05	28	4S310B	82.82	39
4S124E	26.75	61	4S250G	311.72	28	4S310E	82.82	66
4S124G	26.75	24	4S260B	80.04	34	4S310G	82.82	39
4S124G	26.75	33	4S260E	80.04	62	4S310W	82.82	39
4S124W	26.75	24	4S260G	80.04	34	4S319B	23.75	36
4S124W	26.75	33	4S263B	75.36	33	4S319B	23.75	30
4S125B	40.64	33	4S263E	75.36	62	4S319E	23.75	65
4S125B	40.64	24	4S263G	75.36	33	4S319G	23.75	30
4S125E	40.64	61	4S268B	72.71	34	4S319G	23.75	36
4S125G	40.64	24	4S268E	72.71	62	4S319W	23.75	30
4S125G	40.64	33	4S268G	72.71	34	4S319W	23.75	36
4S130G	8.27	31	4S274B	119.94	31	4S321B	29.23	30
4S149	24.05	12	4S274G	119.94	31	4S321G	29.23	30
4S149	24.05	7	4S274W	119.94	31	4S321W	29.23	30
4S159	25.63	7	4S275B	65.25	36	4S322B	29.23	30
4S159	25.63	13	4S275B	65.25	31	4S322G	29.23	30
4S160B	78.69	25	4S275G	65.25	31	4S322W	29.23	30
4S160G	78.69	25	4S275G	65.25	36	4S326B	140.23	20
4S160W	78.69	25	4S281G	223.07	39	4S326B	140.23	22
4S161B	70.84	25	4S283G	214.86	39	4S326B	140.23	39
4S161E	70.84	62	4S288B	118.82	39	4S326G	140.23	22
4S161G	70.84	25	4S288G	118.82	39	4S326G	140.23	39
4S161W	70.84	25	4S290B	98.53	34	4S361G	69.74	25
4S162G	101.68	26	4S290E	98.53	63	4S363B	69.74	26
4S163B	70.84	26	4S290G	98.53	34	4S363G	69.74	26
4S163G	70.84	26	4S291G	393.62	28	4S363W	69.74	26
4S163W	70.84	26	4S292B	55.39	31	4S369G	191.50	30
4S164B	100.89	26	4S292B	55.39	36	4S374G	121.77	31
4S164G	100.89	26	4S292E	55.39	65	4S380G	29.47	40
4S166G	78.44	26	4S292G	55.39	31	4S383G	34.15	40
4S167G	90.27	26	4S292G	55.39	36	4S384G	45.97	40
4S169B	166.66	30	4S292W	55.39	31	4S385G	100.07	40
4S169G	166.66	30	4S292W	55.39	36	4S391G	38.36	40
4S169W	166.66	30	4S296B	39.04	36	4S392	66.79	40
4S173E	89.00	62	4S296B	39.04	31	4S394G	48.43	40
4S173G	89.00	26	4S296E	39.04	65	4S395G	112.41	28
4S179G	100.63	26	4S296G	39.04	31	4S410B	111.31	34

Numerical index

Cat no	Price £ per piece	Page no	Cat no	Price £ per piece	Page no	Cat no	Price £ per piece	Page no
4S410E	111.31	63	4S492B	69.76	36	4S601W	352.98	37
4S410G	111.31	34	4S492E	69.76	65	4S602W	352.98	37
4S414G	231.21	39	4S492G	69.76	36	4S603W	352.98	37
4S416B	12.73	33	4S493B	186.88	36	4S604W	352.98	37
4S416E	12.73	62	4S493E	186.88	63	4S605W	352.98	37
4S416G	12.73	33	4S495B	102.49	34	4S606W	352.98	37
4S430B	246.49	34	4S495E	102.49	64	4S612W	352.98	37
4S430E	246.49	63	4S495G	102.49	34	4S613W	352.98	37
4S430G	246.49	34	4S496B	53.29	33	4S614W	352.98	37
4S435B	66.11	26	4S496E	53.29	61	4S615W	352.98	37
4S435B	66.11	34	4S496G	53.29	33	4S616W	352.98	37
4S435E	66.11	62	4S502B	225.70	30	4S711W	63.59	37
4S435G	66.11	26	4S502G	225.70	30	4S771W	90.99	37
4S435G	66.11	34	4S561B	88.36	26	4S772W	78.96	37
4S435W	66.11	26	4S561G	88.36	26	4S790W	90.69	38
4S435W	66.11	34	4S561W	88.36	26	4S791W	53.63	37
4S440B	90.69	27	4S574B	116.74	36	4T731B	13.00	12
4S440E	90.69	62	4S574E	116.74	65	4T731W	13.00	12
4S440G	90.69	27	4S574G	116.74	36	4T803B	25.98	10
4S440W	90.69	27	4S581B	75.99	29	4T803N	25.98	10
4S444B	90.69	27	4S581G	75.99	29	4T803W	25.98	10
4S444G	90.69	27	4S582B	60.87	29	4T804B	36.08	11
4S444W	90.69	27	4S582G	60.87	29	4T804N	36.08	11
4S445B	100.89	27	4S583B	29.53	29	4T804W	36.08	11
4S445G	100.89	27	4S583G	29.53	29	4T805B	16.12	10
4S445W	100.89	27	4S583W	29.53	29	4T805N	16.12	10
4S450B	73.77	34	4S584B	25.66	29	4T805W	16.12	10
4S450E	73.77	62	4S584G	25.66	29	4T806B	26.79	10
4S450G	73.77	34	4S584W	25.66	29	4T806N	26.79	10
4S461B	69.65	33	4S585B	34.06	35	4T806W	26.79	10
4S461E	69.65	62	4S585E	34.06	65	4T807B	28.41	10
4S461G	69.65	33	4S585G	34.06	35	4T807N	28.41	10
4S461W	69.65	33	4S586B	34.06	35	4T807W	28.41	10
4S462B	75.36	33	4S586E	34.06	64	4T809B	25.73	10
4S462G	75.36	33	4S586G	34.06	35	4T809N	25.73	10
4S463B	69.58	33	4S588B	25.46	29	4T809W	25.73	10
4S463E	69.58	62	4S588B	25.46	35	4T810B	10.28	10
4S463G	69.58	33	4S588E	25.46	64	4T810N	10.28	10
4S469B	175.57	36	4S588G	25.46	29	4T810W	10.28	10
4S469E	175.57	65	4S588G	25.46	35	4T811B	11.87	10
4S469G	175.57	36	4S588W	25.46	29	4T811N	11.87	10
4S474B	116.74	36	4S588W	25.46	35	4T811W	11.87	10
4S474E	116.74	65	4S589B	41.41	29	4T816B	3.77	14
4S474G	116.74	36	4S589G	41.41	29	4T816N	3.77	14
4S483B	30.59	35	4S589W	41.41	29	4T816W	3.77	14
4S483E	30.59	65	4S590B	49.34	30	4T818B	43.59	11
4S483G	30.59	35	4S590B	49.34	36	4T818W	43.59	11
4S484B	30.59	35	4S590E	49.34	65	4T819B	6.94	10
4S484E	30.59	65	4S590G	49.34	30	4T819N	6.94	10
4S484G	30.59	35	4S590G	49.34	36	4T819W	6.94	10
4S490B	98.47	34	4S595E	122.48	64	4T823B	24.44	12
4S490E	98.47	64	4S595G	122.48	27	4T823N	24.44	12
4S490G	98.47	34	4S597E	111.40	64	4T823W	24.44	12
4S491B	436.24	35	4S597G	111.40	27	4T824B	27.00	12
4S491E	436.24	63	4S597G	111.40	34	4T824N	27.00	12
4S491G	436.24	35	4S600W	57.00	38	4T824W	27.00	12

Cat no	Price £ per piece	Page no	Cat no	Price £ per piece	Page no	Cat no	Price £ per piece	Page no
4T825B	15.48	13	4T999W	135.35	11	4Z104G	5.14	41
4T825N	15.48	13	4V003W	3.58	50	4Z104W	5.14	41
4T825W	15.48	13	4V801W	28.28	48	4Z120W	7.49	43
4T826B	19.21	13	4V803W	34.60	48	4Z124G	11.10	41
4T826N	19.21	13	4V804W	53.08	48	4Z124W	11.10	27
4T826W	19.21	13	4V806W	30.74	49	4Z124W	11.10	41
4T830B	80.06	13	4V807W	41.98	48	4Z124W	11.10	64
4T830N	80.06	13	4V808W	53.35	48	4Z124W*	11.10	59
4T830W	80.06	13	4V809W	29.66	48	4Z127W	15.07	43
4T832B	22.93	13	4V811W	25.19	49	4Z128W	14.25	44
4T832N	22.93	13	4V812W	36.94	48	4Z160B	6.85	41
4T832W	22.93	13	4V814W	49.24	48	4Z160G	6.85	41
4T833B	9.19	12	4V816W	49.24	48	4Z160W	6.85	41
4T833N	9.19	12	4V825W	47.11	49	4Z161B	7.20	42
4T833W	9.19	12	4W073B	18.55	45	4Z161G	7.20	42
4T834B	7.82	12	4W073G	18.55	45	4Z161W	7.20	42
4T834N	7.82	12	4W073W	18.55	45	4Z163B	6.44	42
4T834W	7.82	12	4W081B	1.63	45	4Z163G	6.44	42
4T835B	63.46	13	4W081G	1.63	45	4Z163W	6.44	42
4T835N	63.46	13	4W081W	1.63	45	4Z185W	17.95	43
4T835W	63.46	13	4W102B	10.21	43	4Z190B	8.54	42
4T836B	22.15	12	4W102B	10.21	46	4Z190G	8.54	42
4T836W	22.15	12	4W102G	10.21	43	4Z190W	8.54	42
4T837B	27.63	12	4W102G	10.21	46	4Z210W	13.52	43
4T837W	27.63	12	4W102W	10.21	43	4Z260B	9.34	42
4T838B	31.07	13	4W102W	10.21	46	4Z260G	9.34	42
4T838N	31.07	13	4W105B	5.34	45	4Z260W	9.34	42
4T838W	31.07	13	4W105G	5.34	45	4Z263B	5.48	42
4T855B	87.12	13	4W105W	5.34	45	4Z263W	5.48	42
4T858B	87.12	13	4W160B	4.94	45	4Z292B	7.31	43
4T860G	4.23	14	4W160G	4.94	45	4Z292G	7.31	43
4T861G	4.13	14	4W160W	4.94	45	4Z292W	7.31	43
4T862B	33.04	13	4W161B	5.34	45	4Z343G	6.18	51
4T862N	33.04	13	4W161G	5.34	45	4Z343G	6.18	44
4T862W	33.04	13	4W161W	5.34	45	4Z363W	11.07	43
4T864B	4.05	14	4W163B	5.34	45	4Z364W	7.19	43
4T872B	40.83	10	4W163G	5.34	45	5A830W	9.59	50
4T872N	40.83	10	4W163W	5.34	45	5M073B	47.22	68
4T872W	40.83	10	4W166B	4.94	46	5M073E	47.22	68
4T874B	81.70	10	4W166W	4.94	46	5M073W	47.22	68
4T874N	81.70	10	4W190B	5.70	46	5M081E	1.84	68
4T874W	81.70	10	4W190G	5.70	46	5M104B	9.05	68
4T882B	43.53	12	4W190W	5.70	46	5M104E	9.05	68
4T882N	43.53	12	4W260B	5.70	46	5M104W	9.05	68
4T882W	43.53	12	4W260G	5.70	46	5M124E	15.84	68
4T884B	89.16	12	4W260W	5.70	46	5M124W	15.84	68
4T884N	89.16	12	4W292B	5.34	46	5M160B	12.62	68
4T884W	89.16	12	4W292G	5.34	46	5M160E	12.62	68
4T886B	61.51	12	4W292W	5.34	46	5M160W	12.62	68
4T886N	61.51	12	4Z073B	27.31	41	5M161B	15.84	68
4T886W	61.51	12	4Z073W	27.31	41	5M161E	15.84	68
4T888B	122.66	12	4Z074G	36.41	41	5M161W	15.84	68
4T888N	122.66	12	4Z081B	1.82	41	5M163B	11.19	69
4T888W	122.66	12	4Z081G	1.82	41	5M163E	11.19	69
4T894B	28.93	11	4Z081W	1.82	41	5M163W	11.19	69
4T999B	135.35	11	4Z104B	5.14	41	5M190B	19.54	69

Numerical index

Cat no	Price £ per piece	Page no	Cat no	Price £ per piece	Page no	Cat no	Price £ per piece	Page no
5M190E	19.54	69	5W081W	1.55	45	5Z160W	8.10	41
5M190W	19.54	69	5W084B	4.94	47	5Z161B	8.60	42
5M260B	16.72	69	5W084G	4.94	47	5Z161G	8.60	42
5M260E	16.72	69	5W084W	4.94	47	5Z161W	8.60	42
5M260W	16.72	69	5W102B	10.21	43	5Z163B	7.20	42
5M292B	10.42	69	5W102B	10.21	46	5Z163G	7.20	42
5M292E	10.42	69	5W102G	10.21	43	5Z163W	7.20	42
5M292W	10.42	69	5W102G	10.21	46	5Z185W	18.60	43
5M455B	6.67	69	5W102G*	10.21	74	5Z190B	9.00	42
5M455E	6.67	69	5W102W	10.21	43	5Z190G	9.00	42
5M455W	6.67	69	5W102W	10.21	46	5Z190W	9.00	42
5T503B	39.34	19	5W105B	5.70	45	5Z210B	16.44	43
5T504B	44.83	19	5W105G	5.70	45	5Z210G	16.44	43
5T508B	35.15	19	5W105W	5.70	45	5Z210W	16.44	43
5T509B	23.54	19	5W160B	4.95	45	5Z230W	28.98	43
5T510B	11.43	19	5W160G	4.95	45	5Z260B	9.07	42
5T511B	17.24	19	5W160W	4.95	45	5Z260G	9.07	42
5T516B	4.04	20	5W161B	5.34	45	5Z260W	9.07	42
5T519B	8.59	19	5W161G	5.34	45	5Z263B	6.37	42
5T564B	4.58	20	5W161W	5.34	45	5Z263G	6.37	42
5T574B	118.03	19	5W163B	4.94	45	5Z263W	6.37	42
5T594B	37.85	19	5W163G	4.94	45	5Z292B	7.69	43
5T595B	40.83	20	5W163W	4.94	45	5Z292G	7.69	43
5T596B	43.20	20	5W166B	4.94	46	5Z292W	7.69	43
5T999B	157.54	19	5W166G	4.94	46	5Z344G	6.37	44
5V002W	2.90	50	5W166W	4.94	46	5Z363W	11.07	43
5V407W	73.97	50	5W185B	6.35	46	5Z364W	8.10	43
5V407W	73.97	51	5W190B	4.95	46	5Z455B	4.84	44
5V468W	84.85	51	5W190G	4.95	46	5Z455G	4.84	44
5V801W	32.17	48	5W190W	4.95	46	5Z455W	4.84	44
5V802W	37.62	49	5W260B	5.70	46	6S043E	503.87	61
5V803W	51.84	48	5W260G	5.70	46	6S043G	491.72	23
5V805W	56.76	48	5W260W	5.70	46	6S044G	639.81	23
5V806W	25.51	49	5W292B	4.94	46	6S074B	592.37	23
5V807W	48.89	48	5W292G	4.94	46	6S074B	592.37	32
5V808W	63.98	48	5W292W	4.94	46	6S074E	592.37	61
5V809W	39.40	48	5Z073B	33.74	41	6S074G	592.37	23
5V811W	27.35	49	5Z073W	33.74	41	6S074G	592.37	32
5V812W	45.20	48	5Z074G	44.91	41	6S082B	42.86	23
5V814W	62.15	48	5Z081B	1.83	41	6S082B	42.86	32
5V816W	62.16	48	5Z081G	1.83	41	6S082E	42.86	61
5V823W	61.99	49	5Z081W	1.83	41	6S082G	42.86	23
5V842W	52.39	49	5Z085B	6.44	44	6S082G	42.86	32
5V846W	47.74	49	5Z085G	6.44	44	6S084	71.20	23
5V848W	120.04	49	5Z085W	6.44	44	6S084	71.20	32
5V860W	105.43	49	5Z104B	5.28	41	6S099G	138.70	25
5V864W	56.99	50	5Z104G	5.28	41	6S104B	62.25	24
5V869W	83.65	50	5Z104W	5.28	41	6S104B	62.25	32
5V870W	48.73	50	5Z120W	7.49	43	6S104E	62.25	61
5V871W	23.06	50	5Z124G	10.56	41	6S104G	62.25	24
5V901W	36.52	48	5Z124W	10.56	60	6S104G	62.25	32
5W073B	21.47	45	5Z124W	10.56	41	6S105E	156.31	61
5W073G	21.47	45	5Z127W	16.39	43	6S105G	156.31	24
5W073W	21.47	45	5Z128W	15.07	44	6S105G	156.31	32
5W081B	1.55	45	5Z160B	8.10	41	6S124B	91.57	24
5W081G	1.55	45	5Z160G	8.10	41	6S124B	91.57	33

Cat no	Price £ per piece	Page no	Cat no	Price £ per piece	Page no	Cat no	Price £ per piece	Page no
6S124E	91.57	61	6T694G	47.98	21	9T906W	24.04	17
6S124G	91.57	24	6T695B	44.79	21	9T909AG	19.57	17
6S124G	91.57	33	6T696B	47.39	22	9T909B	19.57	17
6S130G	14.68	31	6T999B	218.69	21	9T909G	19.57	17
6S161G	239.89	25	6T999G	231.31	21	9T909N	19.57	17
6S163G	239.89	26	8T806B	31.65	15	9T909W	19.57	17
6S190G	433.25	27	8T806W	31.65	15	9T910AG	8.54	17
6S198G	333.91	28	8T807B	29.33	15	9T910B	8.54	17
6S210G	433.25	28	8T807W	29.33	15	9T910G	8.54	17
6S218G	333.91	28	8T808B	29.33	15	9T910N	8.54	17
6S238G	590.08	28	8T808W	29.33	15	9T910W	8.54	17
6S274G	324.91	31	8T809B	23.72	15	9T911AG	12.03	17
6S292B	121.11	31	8T809W	23.72	15	9T911B	12.03	17
6S292B	121.11	36	8T816B	3.56	16	9T911G	12.03	17
6S292G	121.11	31	8T816W	3.56	16	9T911N	12.03	17
6S292G	121.11	36	8T819B	8.80	15	9T911W	12.03	17
6S302G	61.51	39	8T819W	8.80	15	9T916AG	3.29	18
6S323G	57.56	30	8T840B	13.33	15	9T916B	3.29	18
6S416E	31.90	62	8T840W	13.33	15	9T916G	3.29	18
6S440G	268.08	27	8T841B	18.65	15	9T916N	3.29	18
6S461B	183.50	33	8T841W	18.65	15	9T916W	3.29	18
6S461E	183.50	62	8T843B	34.90	15	9T919AG	6.82	17
6S461G	183.50	33	8T843W	34.90	15	9T919B	6.82	17
6S463B	187.94	33	8T844B	36.71	16	9T919G	6.82	17
6S463E	187.94	62	8T844W	36.71	16	9T919N	6.82	17
6S463G	187.94	33	8T849B	11.71	15	9T919W	6.82	17
6S474B	264.66	36	8T849W	11.71	15	9T964B	3.23	18
6S474E ^A	264.66	65	8T850B	13.33	15	9T974AG	89.54	17
6S474G	264.66	36	8T850W	13.33	15	9T974B	89.54	17
6S490B	313.31	34	8T851B	18.65	15	9T974G	89.54	17
6S490E	313.31	64	8T851W	18.65	15	9T974N	89.54	17
6S490G	313.31	34	8T853B	31.06	15	9T974W	89.54	17
6S498B	241.71	34	8T853W	31.06	15	9T994AG	31.68	18
6S498E	241.71	64	8T854B	36.71	16	9T994B	31.68	18
6S498G	241.71	34	8T854W	36.71	16	9T994G	31.68	18
6S499B	100.47	33	8T864B	3.38	16	9T999B	137.04	18
6S499E	100.47	61	8T874B	110.85	15	9T999G	137.04	18
6S499G	100.47	33	8T874W	110.85	15	9T999W	137.04	18
6T603B	122.02	21	8T894B	34.78	16	12CS050	70.62	108
6T603G	122.02	21	8T894W	34.78	16	12CS080	111.30	108
6T606B	86.88	21	8T999B	150.20	16	12CS100	139.13	108
6T606G	86.88	21	8T999W	150.20	16	12CS300	1.26	108
6T609B	63.26	21	9T903AG	31.10	18	12CS303	8.68	108
6T609G	63.26	21	9T903B	31.10	18	12CS310	31.23	111
6T610B	14.89	21	9T903G	31.10	18	12CS311	31.23	111
6T610G	14.89	21	9T903N	31.10	18	12CS319	247.92	111
6T611B	43.10	21	9T903W	31.10	18	12CS501	2.42	109
6T611G	43.10	21	9T904AG	35.64	18	16CS050	82.88	108
6T616B	4.52	22	9T904B	35.64	18	16CS080	136.26	108
6T616G	4.52	22	9T904G	35.64	18	16CS100	169.31	108
6T619B	22.15	21	9T904N	35.64	18	16CS120	197.01	108
6T619G	22.15	21	9T904W	35.64	18	16CS150	244.31	108
6T664B	4.92	22	9T906AG	24.04	17	16CS200	338.62	108
6T674B	238.01	21	9T906B	24.04	17	16CS300	1.26	108
6T674G	238.01	21	9T906G	24.04	17	16CS303	11.05	108
6T694B	47.98	21	9T906N	24.04	17	16CS307	12.22	111

Numerical index

Cat no	Price £ per piece	Page no	Cat no	Price £ per piece	Page no	Cat no	Price £ per piece	Page no
16CS308	15.46	111	30CS547	0.95	110	3003509	19.09	77
16CS309	24.55	111	35CS400	88.62	112	3003510	19.58	77
16CS500	805.20	108	35CS401	60.29	112	3003511 ^A	29.75	77
16CS501	2.75	109	35CS402	116.13	112	3003512	54.02	77
16CS505	3.50	109	35CS403	91.39	112	3003513*	250.38	77
20CS100	206.91	108	35CS404	69.83	112	3003515	634.51	77
20CS120	264.61	108	35CS405	209.45	112	3003516 ^A	40.62	78
20CS140	308.72	108	35CS406	79.34	112	3003528 ^A	48.69	78
20CS160	352.78	108	35CS407	128.89	112	3003550 ^A	30.79	76
20CS180	396.89	108	35CS408	6.53	112	3003554 ^A	30.03	76
20CS200	441.00	108	35CS409	91.39	112	3003569	5.08	71
20CS300	2.52	108	35CS410	15.69	112	3003570 ^I	5.59	72
20CS307	12.22	111	35CS411	89.62	112	3003572	6.42	71
20CS501	3.08	109	35CS412	3.13	112	3003573 ^I	7.93	72
30CS301	0.07	108	35CS413	55.42	113	3003574	9.33	71
30CS302	2.88	108	35CS414	75.16	113	3003575	11.31	72
30CS304	24.85	108	35CS489	10.55	112	3003576	31.17	71
30CS305	302.33	108	35CS490	10.55	112	3003577	9.13	71
30CS306	0.36	108	35CS498	20.41	113	3003579 ^I	12.24	72
30CS502	144.45	109	35CS499	20.41	113	3003582	14.97	71
30CS503	164.28	109	40CS600	2468.41	114	3003583 ^I	19.65	72
30CS504	192.01	109	40CS601	143.35	114	3003584	47.65	71
30CS505	218.52	109	40CS602	446.93	114	3003585	38.91	71
30CS506	241.11	109	40CS603	2090.74	114	3003587 ^I	50.41	72
30CS507	268.02	109	3003458	67.90	70	3003597	3.99	71
30CS508	295.40	109	3003459	85.10	70	3003598	4.47	72
30CS509	321.28	109	3003460	122.43	70	3003601 ^A	6.99	72
30CS510	348.60	109	3003461	191.32	70	3003602	11.31	72
30CS511	375.93	109	3003462	255.15	70	3003603	11.24	72
30CS512	396.20	109	3003463	406.43	70	3003605 ^A	20.66	72
30CS513	34.15	109	3003464	631.75	70	3003619 ^A	57.81	76
30CS514	111.13	109	3003465	24.18	70	3003620 ^A	57.43	76
30CS515	251.36	109	3003466	28.64	70	3003621 ^A	116.05	76
30CS516	22.09	109	3003467	39.41	70	3003622	8.47	72
30CS517	17.89	109	3003468	45.57	70	3003633	8.83	73
30CS518	12.75	109	3003477	33.73	70	3003634 ^A	10.41	73
30CS519	49.52	109	3003478	7.66	77	3003635Q ^A	8.58	72
30CS520	34.42	109	3003479	7.83	77	3003637Q	9.06	73
30CS521	17.00	110	3003480	8.09	77	3003638	8.76	73
30CS530	35.25	110	3003481	11.27	77	3003639Q	5.79	73
30CS531	67.77	110	3003482	10.98	77	3003641	9.82	73
30CS532	110.59	110	3003483	11.53	77	3003642	10.41	74
30CS533	131.27	110	3003484	20.39	77	3003643Q	11.38	73
30CS534	153.47	110	3003485	26.39	77	3003645Q	10.80	73
30CS535	180.06	110	3003489	7.84	77	3003646 ^A	10.36	73
30CS536	197.84	110	3003493	7.49	77	3003647Q	7.54	73
30CS537	218.99	110	3003494 ^A	7.49	77	3003648 ^A	13.20	74
30CS538	255.41	110	3003495	10.65	77	3003649	9.87	73
30CS539	281.25	110	3003496 ^A	10.65	77	3003650	10.36	73
30CS540	306.66	110	3003497	13.52	77	3003651Q ^A	19.90	73
30CS541	338.04	110	3003498 ^A	21.53	77	3003652	13.17	74
30CS542	356.35	110	3003499	42.46	77	3003654Q	14.77	73
30CS543	4.11	110	3003505	14.83	77	3003655	13.25	74
30CS544	3.92	110	3003506	14.65	77	3003656Q	16.89	73
30CS545	25.20	110	3003507	17.52	77	3003657	13.20	74
30CS546	4.21	110	3003508	18.61	77	3003658Q ^A	20.53	73

Cat no	Price £ per piece	Page no	Cat no	Price £ per piece	Page no	Cat no	Price £ per piece	Page no
3003659 ^Δ	13.20	74	3003743	120.17	76	3003868	34.16	78
3003660Q ^Δ	22.06	73	3003755	57.06	76	3003869	9.95	77
3003661 ^Δ	19.36	74	3003756	56.59	76	3003870	10.10	77
3003662	17.10	73	3003776 ^Δ	68.89	76	3003871 ^Δ	10.10	77
3003663	15.19	74	3003777	76.47	76	3003872 ^Δ	23.86	77
3003664 ^Δ	16.39	73	3003791 ^Δ	134.68	72	3003873	32.14	77
3003665	15.71	74	3003792	18.66	72	3003874	3.56	78
3003666	16.83	73	3003796 ^Δ	5.51	70	3003905 ^Δ	9.46	77
3003667	15.71	74	3003797 ^Δ	5.51	70	3003908 ^Δ	11.46	78
3003668	16.83	73	3003798	4.06	70	3003910 ^Δ	11.46	78
3003669 ^Δ	16.23	74	3003800 ^Δ	5.97	70	3003912 ^Δ	11.46	78
3003670	17.00	73	3003801 ^Δ	5.97	70	3003913 ^Δ	11.46	78
3003671	15.14	74	3003803 ^Δ	6.14	70	3003917 ^Δ	27.04	78
3003672Q ^Δ	20.70	73	3003804 ^Δ	7.50	70	3003921 ^Δ	27.04	78
3003673 ^Δ	16.23	74	3003805 ^Δ	7.50	70	3003924 ^Δ	27.04	78
3003674	16.31	73	3003807 ^Δ	7.50	70	3003927 ^Δ	27.04	78
3003675	16.23	74	3003808	7.50	70	3003935 ^Δ	9.46	77
3003676 ^Δ	22.68	73	3003809	7.50	70	3003936 ^Δ	16.08	77
3003677	22.59	74	3003810	7.43	70	3003937 ^Δ	16.08	77
3003678Q	30.55	73	3003812 ^Δ	11.94	70	3003938 ^Δ	26.58	77
3003679 ^Δ	22.45	73	3003815	11.94	70	3003943	37.93	72
3003680 ^Δ	22.59	74	3003816	13.25	70	3003944	4.74	72
3003681Q ^Δ	27.74	73	3003817 ^Δ	13.25	70	3004372	179.53	88
3003683Q ^Δ	31.27	73	3003820	4.08	70	3004378	350.07	81
3003685	22.45	73	3003821	4.40	70	3004379	466.38	81
3003686 ^Δ	22.59	74	3003822Q ^Δ	5.06	70	3004380	412.40	81
3003687	83.53	74	3003823Q	5.06	70	3004381	514.30	81
3003688	78.09	73	3003824	5.80	70	3011162	50.13	91
3003689	84.39	74	3003825	5.82	70	3014918*	306.68	71
3003690 ^Δ	78.16	73	3003826	5.82	70	3017974*	198.20	76
3003691 ^Δ	64.50	74	3003827Q ^Δ	7.16	70	3017975*	254.68	76
3003698*	168.06	74	3003828	7.79	70	3017976*	307.61	76
3003702*	167.34	74	3003829	7.83	71	3017978*	312.27	72
3003704*	240.51	74	3003830	8.50	71	3017993	30.70	71
3003705*	281.30	73	3003831	8.29	71	3018002*	239.15	74
3003707Q ^Δ	234.86	73	3003832	8.50	71	3018003*	240.68	74
3003709*	311.30	73	3003833	8.51	71	3018005 ^Δ	40.30	72
3003710*	311.50	73	3003834	8.47	71	3018007 ^Δ	57.60	76
3003713 ^Δ	340.66	74	3003835	8.48	71	3018008	14.00	77
3003716 ^Δ	281.30	74	3003836Q ^Δ	14.10	71	3018025 ^Δ	84.76	78
3003718*	520.47	73	3003837Q	14.10	71	3018026 ^Δ	40.62	78
3003719*	526.92	73	3003838Q	14.10	71	3018027 ^Δ	40.62	78
3003723*	497.31	73	3003839	18.57	71	3018028 ^Δ	40.62	78
3003724	8.00	72	3003840	18.58	71	3018029 ^Δ	48.69	78
3003725Q	7.71	72	3003841	4.81	70	3018030 ^Δ	70.90	78
3003726	8.47	73	3003842Q	5.06	70	3018031 ^Δ	374.17	78
3003727	8.43	73	3003843	5.81	70	3018297	327.36	81
3003728	30.90	72	3003856*	305.40	71	3018299	462.85	81
3003730 ^Δ	27.72	72	3003858	7.43	70	3018300	375.38	81
3003732 ^Δ	26.25	76	3003860	4.18	78	3018301	514.59	81
3003734 ^Δ	33.43	76	3003861	3.56	78	3018302	654.69	81
3003736	36.63	76	3003862 ^Δ	3.56	78	3018704 ^Δ	4.39	78
3003738Q ^Δ	50.69	76	3003863	3.57	78	3018705 ^Δ	5.72	78
3003739	48.62	76	3003865 ^Δ	4.51	78	3018706 ^Δ	5.72	78
3003740	50.41	76	3003866	8.47	78	3018707 ^Δ	6.64	78
3003741 ^Δ	60.83	76	3003867 ^Δ	10.57	78	3018708	1.07	78

Numerical index

Cat no	Price £ per piece	Page no	Cat no	Price £ per piece	Page no	Cat no	Price £ per piece	Page no
3018709	1.20	78	3043504	361.56	78	3079773	11.40	82
3018710 ^Δ	6.64	78	3043505	376.21	78	3079774	16.56	82
3018804	509.40	81	3043506	552.18	78	3079775	31.73	82
3018808*	84.25	70	3053972	381.02	88	3079776	6.77	82
3018809*	221.39	70	3061202	1553.79	81	3079777	8.25	82
3018810*	306.68	70	3061211	20.77	81	3079778	11.91	82
3018811	136.20	71	3061212	29.89	81	3079779	13.27	82
3018812	134.92	71	3061213	45.35	81	3079780	14.84	82
3018813	134.92	71	3065639	115.46	88	3079781	23.68	82
3018815Q ^Δ	44.65	76	3065640	109.13	88	3079782	10.32	82
3018818*	187.13	72	3065641	106.10	88	3079783	13.08	82
3018819 ^Δ	455.74	72	3065642	122.97	88	3079784	15.94	82
3018820	108.18	71	3065643	125.13	88	3079785	17.83	82
3018821*	176.86	71	3065644	172.96	88	3079786	27.09	82
3018822 ^Δ	244.46	71	3065645	138.10	88	3079788	7.29	83
3018824Q ^Δ	182.15	73	3065646	133.04	88	3079789	7.42	83
3018826*	428.65	73	3065647	117.84	88	3079790	8.28	83
3018827 ^Δ	367.95	73	3065902	103.62	59	3079791	10.71	83
3018828*	496.99	73	3070529	382.06	81	3079793	14.15	83
3018829*	628.69	73	3070629	367.86	77	3079796	23.91	83
3018830 ^Δ	168.06	74	3070630*	251.99	73	3079797	35.29	83
3018831*	167.34	74	3070631*	119.17	76	3079798	5.37	83
3018832 ^Δ	239.15	74	3070632*	215.04	71	3079799	6.24	83
3018833*	241.38	74	3070633*	168.06	73	3079800	6.85	83
3018834 ^Δ	281.30	74	3070634*	175.51	73	3079801	7.58	83
3018835 ^Δ	281.30	74	3070827	33.14	81	3079802	8.66	83
3018836 ^Δ	283.96	74	3071219	304.88	81	3079803	11.26	83
3018837 ^Δ	283.14	74	3071220	350.07	81	3079804	16.51	83
3021196	107.76	91	3071221	466.38	81	3079805	24.79	83
3024667	45.54	88	3071222	325.45	81	3079806	27.20	83
3024668	49.82	88	3071224	412.40	81	3079811	7.27	82
3027829	65.17	88	3071225	514.30	81	3079812	10.41	82
3027830	47.57	88	3071226	382.06	81	3079813	14.95	82
3027831	53.61	88	3072765	275.12	78	3079814	25.48	82
3027832	34.43	88	3072958	12.14	81	3079815	41.71	82
3027833	34.95	88	3072989	17.39	81	3079816	17.55	83
3027834	38.49	88	3072990	26.47	81	3079817	19.58	83
3027837	39.98	88	3075609	51.07	70	3079818	20.35	83
3027842	49.97	88	3075823	48.47	74	3079819	18.20	83
3027847	90.82	88	3075824 ^Δ	11.24	71	3079820	25.29	83
3027848	102.63	88	3079754	4.29	81	3079821	9.53	82
3027849	112.87	88	3079755	5.59	81	3079822	9.53	83
3027850	92.27	88	3079756	8.40	81	3079823	9.53	83
3027852	87.86	88	3079757	14.61	81	3079824	9.53	82
3027853	122.98	88	3079758	23.27	81	3079825	13.22	83
3027854	110.34	88	3079759	5.96	81	3079826	13.02	82
3027855	92.85	88	3079760	7.71	81	3079827	13.19	83
3027856	83.61	88	3079761	8.43	81	3079828	14.36	83
3028271	292.87	88	3079762	14.26	81	3079829	12.31	83
3041228	56.86	81	3079763	13.97	81	3079833	21.00	82
3041229	91.69	81	3079764	22.41	81	3079834	20.00	83
3043453 ^Δ	51.80	71	3079768	5.35	82	3079835	21.36	83
3043454 ^Δ	59.63	71	3079769	6.73	82	3079836	21.07	83
3043455 ^Δ	97.75	71	3079770	9.55	82	3079837	23.12	83
3043457 ^Δ	140.22	71	3079771	14.89	82	3079839	32.56	83
3043503	275.12	78	3079772	29.14	82	3079840	35.98	83

Cat no	Price £ per piece	Page no	Cat no	Price £ per piece	Page no	Cat no	Price £ per piece	Page no
3079842	32.03	83	3080097	125.35	59	4012326	6.39	75
3079854	14.06	82	3080103	20.47	60	4012329	4.46	75
3079855	17.25	82	3080105	75.30	60	4012331	8.94	75
3079856	17.83	82	3080106	8.69	60	4012333 ^A	10.73	75
3079859	6.21	83	3082542	23.63	77	4012335	9.16	75
3079860	6.89	83	3083259	17.07	82	4012337	9.42	75
3079861	7.89	83	3084561	5.62	77	4012339	7.30	75
3079913	70.31	60	3084562	6.71	77	4012341 ^A	9.92	75
3079915	166.85	60	3084563	3.33	71	4012343	8.20	75
3079917	33.94	60	3084564 ^f	3.35	72	4012345	35.00	75
3079950	29.88	58	3084565	3.36	71	4013530	755.22	90
3079951	31.94	58	3084566 ^f	4.47	72	4013538	263.77	90
3079952	33.71	58	3084567	3.96	72	4013541	418.27	91
3079953	34.17	58	3084570	8.16	72	4013542	90.26	90
3079954	35.05	58	3084571	6.64	73	4013543	90.26	90
3079959	67.81	58	3084572	8.41	72	4013553	38.91	90
3079960	69.68	58	3084573	8.47	73	4013559	50.04	90
3079961	71.63	58	3084574	8.47	72	4013562	53.59	90
3079962	76.91	58	3084575	8.48	73	4013571	32.54	86
3079965	9.35	58	3084576	4.08	70	4013572	32.54	86
3079966	9.35	58	3084577	3.33	72	4013573	32.54	86
3079967	7.69	58	3090788	116.93	89	4020757	68.49	79
3079968	9.35	58	3090826	92.19	89	4023071	30.52	90
3079969	7.69	58	3090828	61.82	89	4023073	33.35	90
3079980	101.91	58	3090829	97.32	89	4023075	43.81	90
3079981	56.83	58	4009725	77.07	73	4023077	496.33	90
3079982	37.50	58	4009748	38.94	78	4023364	94.48	91
3079983	37.50	58	4009749 ^A	77.00	78	4023365	101.39	91
3079985	41.93	58	4009750 ^A	66.31	78	4023375	41.18	75
3079991	116.56	58	4009751 ^A	127.47	78	4023376	46.95	75
3079992	116.56	58	4009761 ^A	11.46	78	4024189	2512.31	79
3079994	160.89	58	4009793	7.90	78	4024190	2924.81	79
3079996	16.78	58	4011390	658.21	79	4024393	2512.31	79
3079997	16.78	58	4011393	673.05	79	4024432	2512.31	79
3080008	274.93	59	4011396	3193.25	79	4024493	2099.85	79
3080010	190.66	58	4011402 ^A	POA	79	4024569	2512.31	79
3080012	30.76	58	4011403	884.60	79	4025509	40.13	79
3080014	59.37	58	4011453	19.54	79	4025566	3.18	60
3080016	9.36	58	4012113	4.88	75	4025568	3.18	60
3080019	24.84	59	4012117	6.73	75	4025986 ^A	35.02	78
3080021	60.65	59	4012118	7.83	75	4025988 ^A	48.78	78
3080023	12.94	59	4012121 ^A	7.06	75	4025989 ^A	35.02	78
3080026	39.89	58	4012122	8.58	75	4025992 ^A	219.44	78
3080030	44.40	58	4012125	7.34	75	4026014 ^A	399.55	79
3080034	67.51	58	4012126	8.65	75	4026102	80.89	60
3080035	75.34	58	4012131	7.88	75	4026106	120.67	60
3080036	86.32	58	4012132	9.91	75	4026109	259.54	60
3080044	74.58	58	4012137	8.62	75	4026438	30.76	75
3080050	165.29	58	4012138	10.01	75	4026439 ^A	31.93	75
3080063	29.72	58	4012141	9.04	75	4026441 ^A	157.05	75
3080078	21.32	60	4012142	9.87	75	4026442 ^A	326.52	75
3080082	41.02	60	4012146	10.06	75	4026689	26.00	86
3080088	21.28	59	4012147	12.24	75	4026690	34.00	86
3080090	62.00	59	4012151	36.47	75	4026691	47.00	86
3080095	125.35	59	4012155	36.97	75	4026692	30.50	86
3080096	125.35	59	4012159	43.05	75	4026693	43.00	86

Numerical index

Cat no	Price £ per piece	Page no	Cat no	Price £ per piece	Page no	Cat no	Price £ per piece	Page no
4026694	59.60	86	4064199	8.05	84	4066029	17.27	85
4026699	6.00	86	4064200	10.84	84	4066030	10.27	85
4031987	173.92	91	4064202	18.02	84	4066031	14.36	85
4031988	169.75	91	4064204	27.11	84	4066033	16.55	85
4035779	702.54	91	4064205	83.24	84	4066034	24.91	85
4035780	251.42	91	4064235	22.26	85	4066035	30.64	85
4036272	50.13	91	4064239	28.06	85	4066041	7.10	85
4036273	103.64	90	4064262	7.87	85	4066042	8.64	85
4036330	3507.35	79	4064271	19.21	85	4066043	10.91	85
4037386	20.27	90	4064273	19.77	85	4066044	14.09	85
4042219 ^Δ	459.84	72	4064274	34.44	85	4066045	13.78	85
4042914	2099.85	79	4064276	38.99	85	4066046	16.18	85
4042915	217.48	79	4064277	8.52	87	4066067	19.61	85
4043224	228.95	90	4064278	8.11	87	4066068	20.00	85
4043225	244.98	90	4064279	10.44	87	4066072	8.64	85
4046556	265.11	91	4064280	15.24	87	4066074	8.64	85
4046557	265.11	91	4064281	17.72	87	4066076	9.59	85
4046558	291.62	91	4064282	23.33	87	4066078	33.27	85
4046559	291.62	91	4064283	25.30	87	4066079	20.53	85
4046560	424.17	91	4064315	39.74	85	4066082	29.85	85
4046691	304.88	91	4064323	11.40	84	4066095	36.00	84
4046694	304.88	91	4064324	16.58	84	4066097	57.00	84
4046695	318.13	91	4064326	25.51	84	4066099	102.55	84
4046756	318.13	91	4064328	38.99	84	4066133	13.99	85
4046758	450.68	91	4064329	42.89	84	4066449	10.59	60
4046759	477.19	91	4064354	16.82	84	4066452	15.14	60
4048906	2651.05	90	4064361	24.24	84	4066454	23.42	60
4048907	4241.67	90	4064371	36.20	84	4066723	231.96	90
4049179	158.33	89	4064881	327.53	77	4066725	450.68	91
4053507	267.24	91	4064882	372.72	77	4067485	22.00	86
4053508	105.51	90	4064999	POA	79	4999998	88.70	91
4053509	503.70	91	4065000	358.96	79	4999999	89.88	91
4053510	490.45	91	4065001	358.96	79	BV1/21 WH	55.29	54
4055036	6.20	87	4065138	24.84	60	BV1 WH	40.89	54
4061068	195.73	77	4065141	24.84	60	BV3 WH	9.83	54
4063088 ^Δ	12.08	75	4065143	24.84	60	BV11 WH	10.32	54
4063089 ^Δ	12.24	75	4065145	3.18	60	CV1 WH	40.89	54
4063090 ^Δ	6.90	75	4065188	2.65	60	CV3 WH	9.83	54
4063092 ^Δ	6.39	75	4065190	6.50	60	CV11 WH	10.32	54
4063093 ^Δ	9.16	75	4065192	3.18	60	FBP3 WH	49.13	55
4063094 ^Δ	8.58	75	4065978	11.16	86	FBP6 WH	98.16	55
4063766	22.53	75	4065979	12.03	86	FCP3 WH	49.13	55
4063767	22.53	75	4065981	15.31	86	FCP6 WH	98.16	55
4063768	22.53	75	4065982	22.36	86	FCW6 WH	4.00	55
4063769	28.64	75	4065983	24.95	86	FSBW6 WH	4.00	55
4063770 ^Δ	28.64	75	4066001	10.73	84	FSCW6 WH	4.00	55
4063772	48.12	75	4066003	1.164	84	HD1/10W	5.45	94
4063971	7.34	84	4066004	15.64	84	HD1/15W	3.26	94
4063972	9.17	84	4066005	21.09	84	HD1/22W	4.59	94
4063974	14.51	84	4066007	34.09	84	HD1/28W	13.22	94
4064166	22.00	84	4066009	11.09	84	HD2/15W	5.65	95
4064167	51.03	84	4066011	12.09	84	HD2/22W	4.37	95
4064182	8.69	84	4066012	16.36	84	HD2/28W	10.59	95
4064185	12.60	84	4066013	22.64	84	HD3B/15W	10.27	95
4064190	18.50	84	4066015	34.55	84	HD3B/22W	8.95	95
4064193	42.89	84	4066028	8.64	85	HD3C/22W	10.27	95

Cat no	Price £ per piece	Page no	Cat no	Price £ per piece	Page no	Cat no	Price £ per piece	Page no
HD4/10W	6.18	94	HD125H/22W	14.38	98	HX44/22W	1.99	96
HD4/15W	4.17	94	HD225A/15W	13.72	98	HX44/28W	2.39	96
HD4/22W	6.18	94	HD225B/15W	15.50	98	HX57/15 GRp/pack	6.66	106
HD4A/15W	6.18	94	HD225B/22W	16.48	98	HX57/22 GRp/pack	6.66	106
HD5/10W	6.18	94	HD225E/15W	29.76	99	HX58/15 GYp/pack	6.66	106
HD5/15W	3.96	94	HD225H/15W	17.23	98	HX58/22 GYp/pack	6.66	106
HD5/22W	5.81	94	HD225H/22W	19.90	98	HX60/10W	0.77	94
HD5/28W	15.82	94	HD425A/15W	9.48	98	HX60/15W	0.78	94
HD8/10W	6.67	95	HRU220FILF7	174.79	115	HX60/22W	1.02	94
HD8/15W	4.63	95	HRU220FILG4	44.74	115	HX60/28W	1.51	94
HD8/22W	6.67	95	HRU220VL	1479.98	115	HX65/10W	0.29	105
HD10/10W	7.63	94	HRU220VR	1479.98	115	HX65/15W	0.47	105
HD10/15W	5.57	94	HRU300H1	1872.63	115	HX65/22W	0.47	105
HD10/22W	7.63	94	HRU300H2	1872.63	115	HX65/28W	0.57	105
HD10/28W	21.83	94	HRU360FILF7	151.71	115	HX75/15 GR	3.04	105
HD12/22W	8.08	95	HRU360FILG4	48.58	115	HX75/22 GR	4.28	105
HD12/28W	21.83	95	HRU360VL	1638.90	115	HX77/10W	2.98	105
HD13/15W	8.08	96	HRU360VR	1638.90	115	HX77/15W	2.44	105
HD13/22W	8.08	96	HRU400FILF7	251.85	115	HX78/10W	0.44	105
HD13/28W	21.83	96	HRU400FILG4	145.00	115	HX78/15W	0.49	105
HD13A/22W	8.08	96	HRU400VL	1727.43	115	HX78/22W	0.49	105
HD13A/28W	21.83	96	HX6/15W	14.00	100	HX78/28W	0.56	105
HD14/15W	8.08	96	HX6/22W	15.22	100	HX79/10W	0.49	105
HD14/22W	8.08	96	HX18/15W	13.96	101	HX79/15W	0.57	105
HD14/28W	21.83	96	HX19/15W	14.60	101	HX79/22W	0.57	105
HD14A/22W	8.08	96	HX20/15W	4.72	96	HX79/28W	0.64	105
HD15/15W	8.08	96	HX20/22W	5.93	96	HX81 GR	728.67	105
HD15/22W	8.08	96	HX20/28W	26.56	96	HX85/15W	0.47	105
HD18/15W	8.08	95	HX22/15W	17.92	101	HX85/22W	0.47	105
HD18/22W	8.08	95	HX22/22W	23.41	101	HX85/28W	0.78	105
HD18/28W	21.83	95	HX24/15W	13.04	100	HX86/15W	0.35	105
HD18A/22W	8.54	95	HX28/10W	9.32	100	HX86/22W	0.47	105
HD25A/15W	5.67	97	HX28/15W	9.08	100	HX88/22W	10.89	102
HD25B/15W	6.71	97	HX28/22W	13.04	100	HX88B/22W	11.25	102
HD25B/22W	7.26	97	HX28/28W	25.62	100	HX89/22W	14.62	102
HD26A/10W	5.76	97	HX29/10W	9.32	100	HX89B/22W	15.16	102
HD26A/15W	4.79	97	HX29/15W	9.08	100	HX91T/22W	30.45	103
HD26B/15W	5.76	97	HX29/22W	13.04	100	HX92/22W	10.89	103
HD26B/22W	6.23	97	HX29/28W	24.77	100	HX92B/22W	11.91	102
HD27/15W	6.26	97	HX30/15W	4.95	100	HX92T/15W	51.14	103
HD62/10W	4.84	94	HX30/22W	8.33	100	HX93T/15W	75.00	104
HD62/15W	4.33	94	HX30/28W	12.23	100	HX94/22W	14.62	103
HD62/22W	5.45	94	HX31/15W	5.06	100	HX94B/22W	15.16	102
HD62/28W	9.08	94	HX31/22W	8.33	100	HX94T/15W	102.40	104
HD74 GR	25.21	105	HX31/28W	12.23	100	HX95A GR	29.31	104
HD75 GR	62.14	105	HX32/15 GY	9.08	100	HX95A GR*	29.31	86
HD78 GR	63.57	105	HX35/15W	14.20	101	HX96/22W	16.72	103
HD125A/15W	10.01	98	HX35/22W	20.22	101	HX96B/22W	16.72	103
HD125B/15W	11.85	98	HX36/15W	25.38	101	HX97 GY	4.46	104
HD125B/22W	11.85	98	HX36/22W	27.29	101	HX97 GY*	4.46	86
HD125D/15W	12.70	98	HX37/15W	12.69	101	HX98 GY	5.17	104
HD125E/15W	27.20	99	HX38/15W	12.06	101	HX98 GY*	5.17	86
HD125EH/15W	27.20	99	HX39 GR	4.70	100	HX100 BL	8.79	106
HD125F/15W*	17.91	99	HX43/22W	33.34	101	HX101/15W	12.24	106
HD125G/15W*	17.91	99	HX44/10W	1.71	96	HX103 BL	2.44	106
HD125H/15W	11.76	98	HX44/15W	1.99	96	HX104 BL	2.95	106

Numerical index

Cat no	Price £ per piece	Page no	Cat no	Price £ per piece	Page no	Cat no	Price £ per piece	Page no
HX109 GY	4.72	104	KL6-15	14.00	100	KL125G-15*	17.91	99
HX110 GY	3.95	104	KL6-22	15.22	100	KL125H-15	11.76	98
HX112 GY	0.26	104	KL8-10	6.67	95	KL125H-22	14.38	98
HX113 WH	10.36	104	KL8-15	4.63	95	KL225A-15	13.72	98
HX200	17.33	106	KL8-22	6.67	95	KL225B-15	15.50	98
HXC25/15 BL	52.98	106	KL10-10	7.63	94	KL225B-22	16.48	98
HXC25/22 BL	66.30	106	KL10-15	5.57	94	KL225E-15	29.76	99
HXC50/15 BL	106.05	106	KL10-22	7.63	94	KL225H-15	17.23	98
HXC50/22 BL	131.90	106	KL10-28	21.83	94	KL225H-22	19.90	98
HXX03/15W	10.69	93	KL12-22	8.08	95	KL425A-15	9.48	98
HXX03/22W	20.89	93	KL12-28	21.83	95	KLB20-28HX	26.56	96
HXX03/28W	28.65	93	KL13-15	8.08	96	KLB22-15	17.92	101
HXX06/15W	22.04	93	KL13-22	8.08	96	KLB22-22	23.41	101
HXX06/22W	43.25	93	KL13-28	21.83	96	KLB24-15	13.04	100
HXX06/28W	58.98	93	KL13A-22	8.08	96	KLB28-10	9.32	100
HXX10/15W	34.12	93	KL13A-28	21.83	96	KLB28-15	9.08	100
HXX10/22W	66.58	93	KL14-15	8.08	96	KLB28-22	13.04	100
HXX10/28W	89.75	93	KL14-22	8.08	96	KLB28-28	25.62	100
HXX25/10W	72.46	93	KL14-28	21.83	96	KLB29-10	9.32	100
HXX25/15W	85.24	93	KL14A-22	8.08	96	KLB29-15	9.08	100
HXX25/22W	166.40	93	KL15-15	8.08	96	KLB29-22	13.04	100
HXX25/28W	224.37	93	KL15-22	8.08	96	KLB29-28	24.77	100
HXX50/10W	142.74	93	KL18-15	8.08	95	KLB35-15	14.20	101
HXX50/15W	168.70	93	KL18-22	8.08	95	KLB35-22	20.22	101
HXX50/22W	329.48	93	KL18-28	21.83	95	KLB91T-22	30.45	103
HXX50/28W	446.61	93	KL20-15	4.72	96	KLB92T-15	51.14	103
HXX80/15W	269.92	93	KL20-22	5.93	96	KLB93T-15	75.00	104
HXX100/10W	281.19	93	KL25A-15	5.67	97	KLB94T-15	102.40	104
HXX100/15W	332.19	93	KL25B-15	6.71	97	S170 WH	74.39	55
HXX120/15W	398.64	93	KL25B-22	7.26	97	S171 WH	71.30	55
HXXC2528 BU	431.68	93	KL26A-10	5.76	97	S172 WH	68.23	55
HXXC2528 RD	431.68	93	KL26A-15	4.79	97	S951 BL	53.88	55
HXXC5010 BU	296.46	93	KL26B-15	5.76	97	VCONT001	179.33	115
HXXC5010 RD	296.46	93	KL26B-22	6.23	97	WC004W	28.61	38
HXXC5015 BU	340.88	93	KL27-15	6.26	97	WC204W	34.91	38
HXXC5015 RD	340.88	93	KL62-10	4.84	94	WC404W	34.97	38
HXXC5022 BU	524.35	93	KL62-15	4.33	94	WC904W	40.78	38
HXXC5022 RD	524.35	93	KL62-22	5.45	94			
KL1-10	5.45	94	KL62-28	9.08	94			
KL1-15	3.26	94	KL88-22	10.89	102			
KL1-22	4.59	94	KL88B-22	11.25	102			
KL1-28	13.22	94	KL89-22	14.62	102			
KL2-15	5.65	95	KL89B-22	15.16	102			
KL2-22	4.37	95	KL92-22	10.89	103			
KL2-28	10.59	95	KL92B-22	11.91	102			
KL3B-15	10.27	95	KL94-22	14.62	103			
KL3B-22	8.95	95	KL94B-22	15.16	102			
KL3C-22	10.27	95	KL96-22	16.72	103			
KL4-10	6.18	95	KL96B-22	16.72	103			
KL4-15	4.17	95	KL125A-15	10.01	98			
KL4-22	6.18	95	KL125B-15	11.85	98			
KL4A-15	6.18	95	KL125B-22	11.85	98			
KL5-10	6.18	94	KL125D-15	12.70	98			
KL5-15	3.96	94	KL125E-15	27.20	99			
KL5-22	5.81	94	KL125E+15	27.20	99			
KL5-28	15.82	94	KL125F-15*	17.91	99			

Notes

Important notes

All purchases are subject to our standard terms and conditions of sale, available at www.wavin.co.uk/general-conditions or call for a copy.

Prices are subject to VAT at the current rate.

Wavin operates a programme of continuous product development, and therefore reserves the right to modify or amend the specification of their products without notice. All information in this publication is given in good faith, and believed to be correct at the time of going to press. However, no responsibility can be accepted for any errors, omissions or incorrect assumptions. Users should satisfy themselves that products are suitable for the purpose and application intended.

Quality assurance

Wavin manufacturing sites operate Environmental Management Systems which comply with the requirements of and are certified to EN ISO 14001:2015, Certificate No. 42231.

All Wavin products are manufactured under a quality management system which is approved to BS EN ISO 9001:2015.

Orders and enquiries

Tel: 0800 038 0088

For further information on our product ranges, see the following:

Wavin website

www.wavin.co.uk is the place to find overview of our ranges, individual item information (such as photo, dimensions, etc), literature via our download centre, news and events, blogs, online calculation tools, links to 'How to Videos' and more.

Download centre on [wavin.co.uk](http://www.wavin.co.uk)

Visit our website download centre for electronic copies of:

- Product, Design and Installation Guides
- Price list
- Safety sheets
- Quality certificates
- CAD files, etc.

'How to' videos

To support Osma, Hep₂O Plumbing & Heating and Wavin brands, there are a series of 'How to' videos to show how you can make light work of installation problems. They can be viewed at youtube.com/WavinUK

YouTube



Online Tools and E-Learning

We have lots of resources available to help you with your projects. Our e-learning modules will bring you up to date on our products and the latest regulations. You can also access a number of calculation tools – and all for free. Just visit myportal.wavin.co.uk

Wavin knowledge centre

Keep ahead of breaking news with a fresh and insightful look into the construction industry. Our aim is to keep you informed and up to date with the latest how-to guides, regulations, innovation and more. Visit blog.wavin.co.uk

BIM centre

Register on myportal.wavin.co.uk for access to our Revit content package, which helps you create accurate designs and generate a comprehensive bill of materials.

X accounts

Join the conversation:

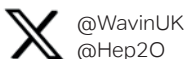

@WavinUK
@Hep2O

Contact

Orders and enquiries:
Complex technical queries:
General enquires:

0800 038 0088
technical.design@wavin.co.uk
info@wavin.co.uk

NEW Hep₂O Keyless

50
Year
Guarantee

Smaller,
slimmer
fitting

Optimised
flow rate

Compatible
with other
systems



Pre-locked
for speedier
installation

In4Sure
technology



Simply twist
to unlock
and lock

With two great
Hep₂O systems to
choose from, to
key or not to key
is now the only
question?



Scan
for your
FREE
sample pack



Wavin Limited
Registered Office
Edlington Lane
Doncaster | DN12 1BY
Tel. 0800 038 0088
www.wavin.co.uk | info@wavin.co.uk



An Orbia business.

August 2024