

Product Catalogue

Polyethylene Pipes

For Potable Water Applications



wavin



Wavin is one of the leading companies in the plastic pipe industry in Turkey. Our company offers a wide range of high-quality pipe and fittings system solutions for building and infrastructure. Our company, which has a history of more than half a century, started production in 1971 in Adana. Pilsa Plastik A.Ş. was purchased by Wavin B.V, the largest European company in its own field in the Netherlands in 2008.

In 2012, all Wavin companies joined the Mexichem family which is South America's giant petrochemicals and raw materials producer. Mexichem announced its new name as ORBIA in 2019. ORBIA, with its new changing business structure, provides professional support to its customers with its products and services in 5 main business lines: Building & Infrastructure, Flour, Datacom, Precision Agriculture and Polymer Solutions. With the new structuring of ORBIA, its main mission is to advance life around the world.

In 2019, with the renewed business structure of ORBIA, building & infrastructure business line was started to represent by WAVIN, a single and strong brand across the globe. WAVIN operates in more than 40 countries around the world in 4 main regions: Europe-Middle East-Africa, Asia-Pacific, Latin America and USA-Canada with 12.000 employees.

Wavin is now a global leader in the supply of plastic pipe systems and solutions for both above and below ground applications in projects around the world. Since the 1950s, we have built an unrivalled reputation for continuous innovation, intelligent problem-solving, dedicated technical support and the highest standards.

Wavin Turkey offers traditional products such as PPR-C clean water, PVC wastewater as well as the innovative products such as Tigris Press-fit systems, SiTech+ low noise pipes, Qickstream siphonic rainwater drainage systems, Q-Bic Plus infiltration systems, Tegra plastic manholes etc. to the sector. Wavin Academy which is the first training centre of the sector. was opened in 2014 within our factory in Adana, Tens of thousands of visitors from various levels of the mechanical installation sector have been able to increase their expertise by attending training at Wavin Academy since 2014. Our company provides fast service with Adana, Istanbul, Ankara and Izmir offices, distribution centres located in Istanbul and Adana and wide dealers network. In addition to our sales staff, our expert engineers and technical personnel support our customers for the projects.

To get more information about our company and products, please visit our website www.wavin.com.tr and follow us on our social media accounts.

Polyethylene Pipes

The most prominent feature of PE pipes is the high impact resistance and comfortable laying.

Due to its flexibility, PE pipes provide safe use in rocky and uneven areas and landslides

Pipes made of low density polyethylene (LDPE) have been used successfully in systems that do not require high pressure. However, these materials have the opportunity to be used only in systems requiring low pressure due to their technical properties. Developed after long researches and studies, high density polyethylene (HDPE) is the most powerful PE pipe material developed up to the present. HDPE pipes with the same operating pressure and diameter have a thinner wall thickness than low density pipes. In this respect, the thinner wall thickness of HDPE pipes creates a larger inner diameter and it is possible to use smaller diameter for the same flow rate, but it also saves raw material.

Wavin manufactures these superior HDPE pipes according to TS EN 12201-1, ISO 4427 and DIN 8074 under the control of ISO 9001:2008

Usage Areas Of HDPE Pipes

- Ground and surface drinking and tap water networks.
- Marine discharge systems
- Sewerage discharge systems
- Waste water systems
- Solid waste (garbage) drainage systems
- Drainage projects
- Agricultural Irrigation Systems
- Irrigation of play fields and garden areas
- Geothermal systems and mining operations
- Pharmaceutical and chemical industry
- Cement Industry
- Petrochemical Industry
- Food Industry
- Marine and fishing, marinas
- In buildings and many industrial systems
- Fire water and cooling water systems
- Telecommunication cabling systems and many other areas



Raw Material and Technical Specifications

HDPE Raw Material Specifications

HDPE Raw Material Specifications	Test Conditions	Unit	Test Method	Result
MRS Classification	20°C, extrapolation 50 years	MPa	ISO 9080	10
Density	23°C	g/cm ³	ISO 1183	≥0,930
Melt Flow Index	190°C, 5 kg	g/10 min	ISO 1133	0,2-1,4
Elasticity Module	23°C, 1 mm/dk	MPa	ISO 527	800-1200
Carbon Black Amount	550 ±50 °C	%	ISO 6964	2-2,5
Carbon Black Dispersion	100X	-	ISO 18553	≥3 A1,A2,A3, B
Oxidation Induction Time	200°C	min	ISO 11357-6	≥20

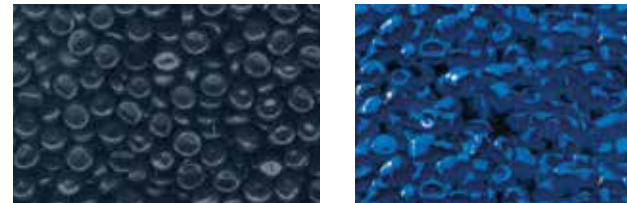

Tests Applied to HDPE Pipes

HDPE pipes are subjected to the following tests periodically during their production based on TS 418-2 EN 12201-2 standard.

Tests Applied to HDPE Pipes	Unit	Test Method	Result
Melt Flow Index Change (190°C, 5 kg)	%	ISO 1113	≥20
Elongation at break	%	TS EN ISO 6259	≥350
Hydrostatic Stress (20°C), 12 Mpa	time	ISO 1167	≥100
Hydrostatic Stress (80°C), 5,4 MPa	time	ISO 1167	≥165
Hydrostatic Stress (80°C), 5 MPa	time	ISO 1167	≥1000
Oxidation Induction Time	min	ISO11357-6	≥20
Dimensional change	%	EN ISO 2505	≥3
Effect on drinking water quality	-	National Legislation	Appropriate

Service Life of HDPE Pipes (Hours)

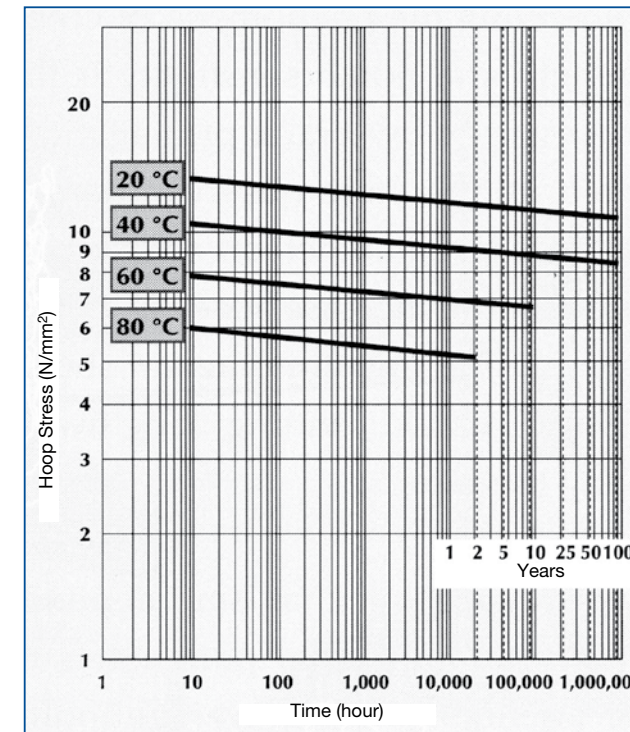

Coil Dimensions

PE pipes are produced as coil or straight tube according to their diameters and pressure classes. PE pipes can be rotated 360° with a certain radius without using elbows depending on the mechanical properties of the raw material. Due to this feature coil diameters can be 18-35 times more than the pipe diameter. The number of spigot joint in coil pipes decreases, projects are terminated quickly with an increasing installation speed. Installation labor costs, transportation and inventory costs decrease.



LDPE Pipes Coil Sizes

Pipe Diameter (mm)	Inner Diameter (cm)	Outer Diameter (cm)	Coil Width (cm)	Coil Height (mt)
Ø16	40	55	21	100
	40	70	21	200
Ø20	40	65	21	100
	40	85	21	200
	60	90	21	200
Ø25	40	75	21	100
	40	100	21	200
	60	110	21	200
Ø32	60	95	26	100
Ø40	60	100	36	100
Ø50	60	115	36	100
Ø63	100	140	40	100
Ø75	100	145	40	100
Ø90	165	200	50	100
Ø110	165	210	50	100

HDPE Pipes Coil Sizes

Pipe Diameter (mm)	Inner Diameter (cm)	Outer Diameter (cm)	Coil Width (cm)	Coil Height (mt)
20	100	110	21	100
25	100	120	21	100
32	100	130	26	100
40	130	170	36	100
50	130	170	36	100
63	166	190	40	100
75	175	205	40	100
90	225	260	50	100
110	225	270	50	100

Wall Thicknesses, Dimensions and Tolerances According to Pressures

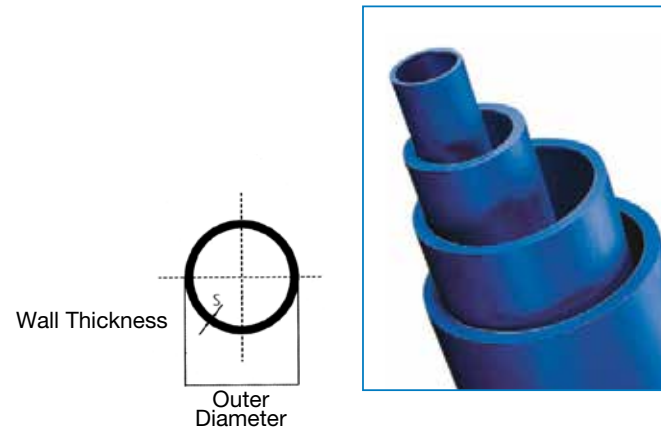

Measurement is millimeter

Pipe Series																		
	SDR 7,4 S 3,2		SDR 9 S 4		SDR 11 S 5		SDR 13,6 S 6,3		SDR 17 S 8		SDR 21 S 10		SDR26 S12,5		SDR 33 S 16		SDR 41 S 20	
Nominal Pressure Ratings, PN(bar)																		
LDPE	PN 10		-		PN 6		-		PN 4		-		-		-		-	
HDPE	PN 25		PN 20		PN 16		PN 12,5		PN 10		PN 8		PN 6		PN5		PN 4	
Wall Thicknesses																		
Nom. Diameter DN/OD	émin	émax	émin	émax	émin	émax	émin	émax	émin	émax	émin	émax	émin	émax	émin	émax	émin	émax
16	2,3	2,7	2,0	2,3	-	-	-	-	-	-	-	-	-	-	-	-	-	-
20	3,0	3,4	2,3	2,7	2,0	2,3	-	-	-	-	-	-	-	-	-	-	-	-
25	3,5	4,0	3,0	3,4	2,3	2,7	2,0	2,3	-	-	-	-	-	-	-	-	-	-
32	4,4	5,0	3,6	4,1	3,0	3,4	2,4	2,8	2,0	2,3	-	-	-	-	-	-	-	-
40	5,5	6,2	4,5	5,1	3,7	4,2	3,0	3,5	2,4	2,8	2,0	2,3	-	-	-	-	-	-
50	6,9	7,7	5,6	6,3	4,6	5,2	3,7	4,2	3,0	3,4	2,4	2,8	2,0	2,3	-	-	-	-
63	8,6	9,6	7,1	8,0	5,8	6,5	4,7	5,3	3,8	4,3	3,0	3,4	2,5	2,9	-	-	-	-
75	10,3	11,5	8,4	9,4	6,8	7,6	5,6	6,3	4,5	5,1	3,6	4,1	2,9	3,3	-	-	-	-
90	12,3	13,7	10,1	11,3	8,2	9,2	6,7	7,5	5,4	6,1	4,3	4,9	3,5	4,0	-	-	-	-
110	15,1	16,8	12,3	13,7	10,0	11,1	8,1	9,1	6,6	7,4	5,3	6,0	4,2	4,8	-	-	-	-
125	17,1	19,0	14,0	15,6	11,4	12,7	9,2	10,3	7,4	8,3	6,0	6,7	4,8	5,4	-	-	-	-
140	19,2	21,3	15,7	17,4	12,7	14,1	10,3	11,5	8,3	9,3	6,7	7,5	5,4	6,1	-	-	-	-
160	21,9	24,2	17,9	19,8	14,6	16,2	11,8	13,0	9,5	10,6	7,7	8,6	6,2	7,0	-	-	-	-
180	24,6	27,2	20,1	22,3	16,4	18,2	13,3	14,8	10,7	11,9	8,6	9,6	6,9	7,7	-	-	-	-
200	27,4	30,3	22,4	24,8	18,2	20,2	14,7	16,3	11,9	13,7	9,6	10,7	7,7	8,6	-	-	-	-
225	30,8	34,0	25,2	27,9	20,5	22,7	16,6	18,4	13,4	14,9	10,8	12,0	8,6	9,6	-	-	-	-
250	34,2	37,8	27,9	30,8	22,7	25,1	18,4	20,4	14,8	16,4	11,9	13,2	9,6	10,7	-	-	-	-
280	38,3	42,3	31,3	34,6	25,4	28,1	20,6	22,8	16,6	18,4	13,4	14,9	10,7	11,9	-	-	-	-
315	43,1	47,6	35,2	38,9	28,6	31,6	23,2	25,7	18,7	20,7	15,0	16,6	12,1	13,5	9,7	10,8	7,7	8,6
355	48,5	53,5	39,7	43,8	32,2	35,6	26,1	28,9	21,1	23,4	16,9	18,7	13,6	15,1	10,9	12,1	8,7	9,7
400	54,7	60,3	44,7	49,3	36,3	40,1	29,4	32,5	23,7	26,2	19,1	21,2	15,3	17,0	12,3	13,7	9,8	10,9
450	61,5	67,8	50,3	55,5	40,9	45,1	33,1	36,6	26,7	29,5	21,5	23,8	17,2	19,1	13,8	15,3	11,0	12,2
500	-	-	55,8	61,5	45,4	50,1	36,8	40,6	29,7	32,8	23,9	26,4	19,1	21,2	15,3	17,0	12,3	13,7

Pipes Specifications

- Long service life. No corrosion risk. Although HDPE pipe service life is calculated as at least 50 years, the actual performance of pipes exceeds this period.
- Flexible. Perfectly fits the landform. It is not affected from earth movements. It can be easily used in sea, stream, river, lake and rough ground, in areas where there may be earth movements such as mining areas, earthquake zones.
- Robust. High cracking and impact resistance. Easy to load, transport and lay.
- High resistance to chemicals. It has the ability to work in acidic, basic and salty environments. It is not affected by corrosion, does not corrode, wear.
- It is not necessary to take precautions during laying such as cathodic protection since it is not affected by abrasive substances in the soil.
- The inner surface is smooth. The pipe diameter used during designing the project is minimized and consumes less electrical energy during the operation. Operating costs are reduced.
- It has high resistance to sunlight due to its chemical structure. (UV resistance)
- Due to its excellent welding properties it does not come away and break from the joints under the pressure and provide precise sealing. (Butt welding, Electrofusion etc..)
- It is lightweight. It is installed easily and quickly. It can be assembled inside and outside the duct during the installation.
- It provides a big advantage in areas with short construction season and on heavy traffic roads. It is economical because there is less need for excavation, less filling and less outside supply of filling from the construction site.
- It can be produced in the form of coil and straight tube. It requires less elbows. There is no need for elbows during laying. In places like "T" there is no need for concrete mass.
- Variation in pressure class PN4 to PN25 can be produced in any pressure class and can be produced on demand.
- Since PE100 pipes are dirt-repellent, non-toxic and resistant to micro-organisms there is no harm in food contact with the approval of the Ministry of Health.

Advantages

Compared to LDPE and PE80;

The higher MRS value of PE100 ensures that the pipes produced from PE100 have a thinner wall thickness than LDPE and PE80 pipes of the same diameter and pressure level. Therefore, friction losses are lower.

Compared with PVC;

- It has a much higher impact resistance. The modulus of the elasticity of the pipe wall is higher.
- The damping capability of the water hammer is higher.
- PE pipes can be produced in coils up to Ø125 diameter. The other diameter of PE100 pipes are 12 or 13,5m. in length. In coil pipes, the number of spigot joint is low, the installation speed increases. Labor, transportation and inventory costs decrease. The length of PVC pipes is 6 meters.
- Due to its bendability in turns, less elbows are needed.
- PE100 pipes are joined with Butt Welding or Electrofusion fittings without the need for gaskets.
- It can be used safely in soft ground and earthquake zones.

Compared with STEEL, CONCRETE, GRP and ASBESTOS;

- It has much higher impact resistance than concrete, GRP and Asbestos pipes. The modulus of the elasticity of the pipe wall is very higher.
- PE pipes can be produced in coils up to Ø125 diameter. The standard length of PE pipes with other diameters is 12meters.
- Comparing to Steel, Concrete, GRP and Asbestos pipes, less bends are required due to the ability of bending in turns.
- It is lighter than Steel, Concrete, GRP and Asbestos pipes It is east to carry.
- Comparing to Steel, Concrete, GRP and Asbestos pipes, hygienic superiority is available.
- Comparing to Steel, Concrete, GRP and Asbestos pipes, it has high chemical resistance.
- Comparing to Steel, Concrete, GRP and Asbestos pipes, it has high wear resistance.
- Comparing to Steel, Concrete, GRP and Asbestos pipes, it does not corrode.

Connection Methods

PE100 pipes are the most diverse in terms of spigot joints techniques. Each of these techniques is preferred depending on where the pipes are to be used.

Butt Welding Method



This application is the general use. It is made with a special butt welding machine. The principle of the system is the process of heating the pipe faces to be welded under a predetermined pressure and time using a resistive plate, and making butt joint under the predetermined time and pressure and then cooling. The welding process is very economical as it does not require additional sleeves. This method is recommended for diameters greater than Ø63

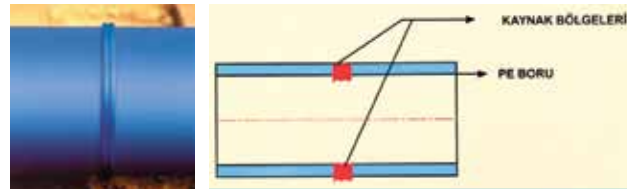

Advantages of Butt Welding

- No special insert is required for jointing.
- Fittings such as elbows and "T" can be produced with butt welding.
- It is easy to obtain the welding machine. It is produced in our country. It is an easy method.
- Fittings are cheaper.
- It can be applied easily to pipes having diameter more than Ø63 (wall thickness greater than 3mm)
- Lip-welds formed inside and outside as a result of the application increase the weld cross section which increases the safety.
- It is a reliable, appropriate welding process.
- When a suitable welding connection is made the strength of the welded area will be equivalent to the strength of the main pipe.

Points to be considered during Butt Welding

- Materials to be welded must be of the same parametric value. (They should have the same wall thickness)
- The working area should be clean and the surface to be welded must be protected from rain, snow, mud or oil.
- The surface to be welded should not be touched.
- The weather conditions should be appropriate (wind, heat, humidity, dust, etc.) (Ambient temperature should not be less than 5 °C.)
- The welder must be well trained.

Butt Welding Process Steps

1. Pipes are placed on butt welding machine and clamped firmly with apparatus.
2. The shaving apparatus is placed on the column shafts of the welding machine and the front surfaces of the pipes are shaved carefully.
3. It is checked whether the shaved surfaces are in the same axis and whether it is made butt joint.
4. The front surfaces of the pipes are removed from each other in such a way that the heating plate enters.
5. Under the heat and pressure determined according to the data of the welding machine manufacturer or the data calculated by formulas, the heating plate is applied to the pipe face surface.
6. The heating plate is removed and the pipes are connected by butt joint and kept under pressure for a certain period of time.
7. At the end of the period, the pressure is removed and the pipe is allowed to cool.



Pipe Welding Area Calculation Formula:

$$A_{BORU} = \frac{(da^2 - di^2) \cdot \pi}{4}$$

$$VEYA \approx dm \cdot \pi \cdot s \text{ (mm}^2\text{)}$$

A_{boru} : Pipe Welding Area
 da : Outer Diameter
 di : Inner Diameter
 dm : Medium Diameter

Welding Compression Force Calculation:

$$F = P_{Spesifik} \cdot A_{Boru} \text{ (N)}$$

A_{boru} : Pipe Welding Area
 da : Compression Force
 di : PE = 0.15 N/mm²
 dm : PP = 0.10 N/mm²

Butt Welding Stages:

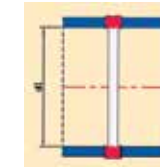

Butt Welding Time Chart:

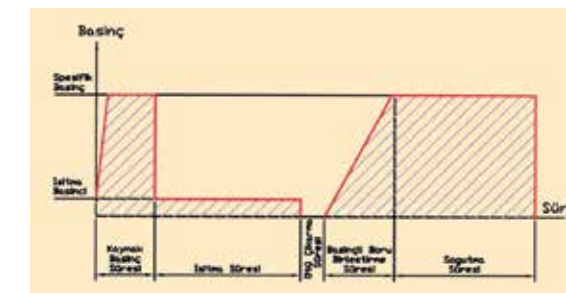

Welding Preparation

(Shaving) - Heating - Jointing and Cooling

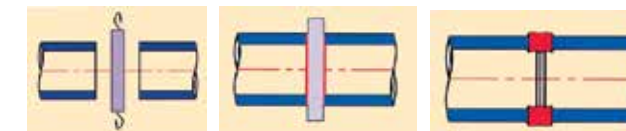

Electrofusion Welding Method

This application is generally used in systems where very high safety is required, in places where butt welding method is not used due to space constraints and is used on repairs. Electrofusion welding machine and electrofusion fittings are used in the installation. Special resistance wires are placed on the inner surfaces of these electrofusion fittings to be welded with pipes.

These wires are given voltage by the electrofusion machine and the inner surface of the electrofusion fitting to be joined to the pipe is brought to the melting temperature. Fittings and pipes are welded. In addition, it is possible to take outputs from the main pipe by applying this technique.

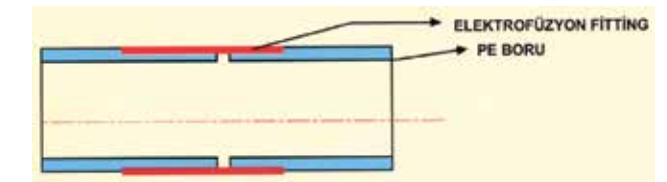

Advantages of Electrofusion Welding

- It is possible to get direct output from the main pipe using this technique.
- Pipes are easy to be repaired.
- It can be applied easily even in very narrow areas.
- It does not require much excavation fill.

Points to be considered during Electrofusion Welding

- Materials to be welded must be of the same parametric value.
- The working area should be clean and the surface to be welded must be protected from rain, snow, mud or oil. The surface to be welded should not be touched.
- The permissible ambient temperature for the electrofusion is 5C° - 45C°
- The welder must be well trained.

Electrofusion Welding Process Sequence

1. Pipes are cut neatly at the right angle with their axis.
2. The surface of the pipe to be welded is cleaned by peeling the outer surface of the pipe with a peeling apparatus so that no oil or dirt remains.
3. Pipe and fittings are cleaned with alcohol. The fitting is fixed to the pipe.
4. The barcode of the fitting is read to the machine, otherwise the values are entered manually.
5. The welding machine is started and the process is completed.

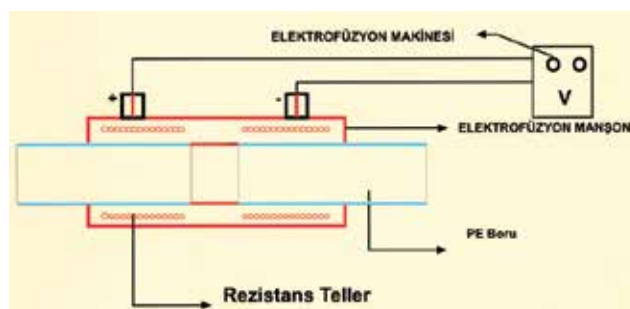
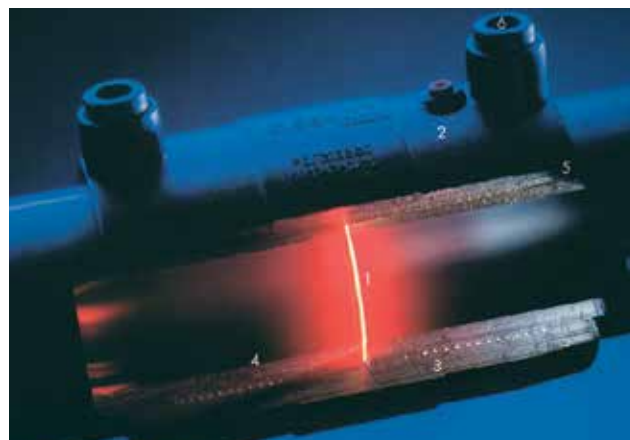

Flange Joining Method

Steel flanges are placed on the flange adaptor and the ends to be joined are welded with adaptor butt welding. The welding rules for butt welding also apply here. A gasket is placed among the two flanges and the flanges are joined with nuts and bolts.

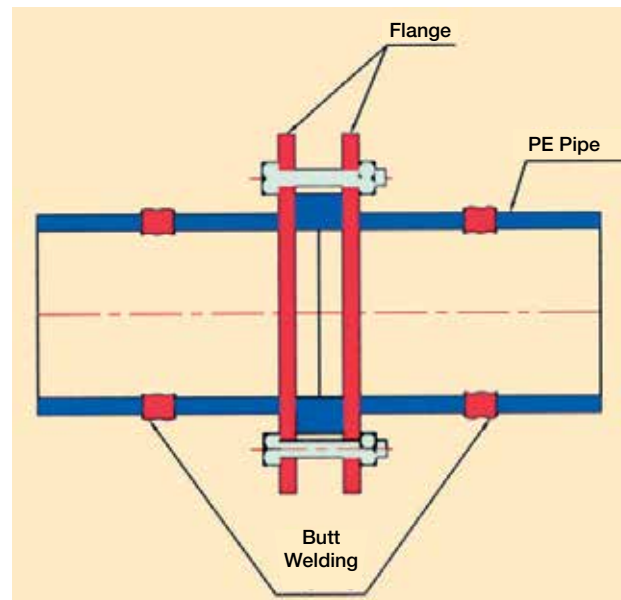

Polyethylene Pipes Classification

Indication of material with signs and design tension.

Pipe Class	Minimum Required Strength(MRS)	Design Pressure MPA
HDPE	10,0	8,0
LDPE	3,2	2,5

Note: The design tension, the design coefficient are derived from MRS when C=1,25.

Specifications	HDPE	LDPE
Melt Flow Index (g/10dak) 190oC-2,16 kg.	0,07	0,4
Density g/cm3	0,95	0,920
Thermal Resitance min.	>60	>40
Tensile Strain at Break %	≥600	≥600
Tensile Stress at Yield	>20	>10
Modulus of Elasticity, Mpa	950	500



Q = MRS/C
 C : Safety factor (1,25)
 MRS : Minimum required strength

MRS and SDR Ratios of PE Pipes

$$SDR = \frac{D}{s}$$

D = Outer Diameter

s = Wall thickness

SDR = Standard dimension ratio

$$S_b = \frac{Q}{PN} = \frac{SDR-1}{2}$$

Q = Pipe Strength

PN = Nominal Pressure

S_b = Pipe Classification

$$PN = \frac{10 \cdot Q}{S_b} = \frac{20 \cdot Q}{SDR-1}$$

$$SR = \frac{EI}{r^3m}$$

SR = Relative stiffness

E = Modulus of Elasticity

I = Geometrical moment of inertia

r m = Average radius

From the formula for drinking water pipes

$$SR = \frac{2E}{3(SDR-1)^3} = 0,66 \frac{E}{(SDR-1)^3}$$



Calculations

Calculation of Wall Thickness of Pipe

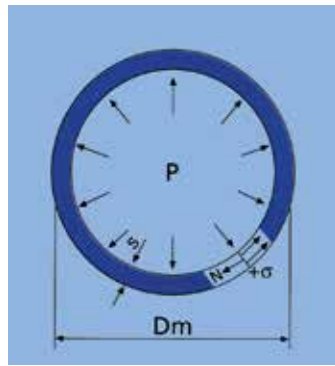

$$N = \frac{pD_m}{2}$$

D : Mean diameter
p : Inner pressure
N : tension

$$D_m = \frac{D+d}{2} = D-s$$

Stress on pipe walls

$$\sigma = \frac{pD_m}{2s}$$

Wall thickness $s = \frac{pD_m}{2\sigma}$

Since PE pipes are referred with outer diameters in international standards they are obtained by replacing D_m with the formula

$$s = \frac{pD}{2\sigma + p}$$

and used in the pipe wall thickness calculation.

External Hydrostatic Pressure

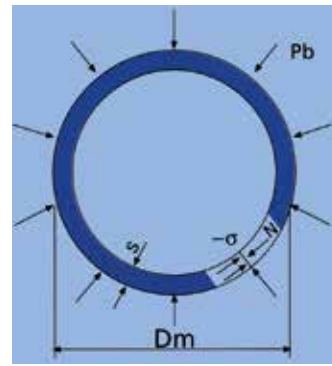

In case of external hydrostatic pressure

$$N = \frac{P_b D_m}{2}$$

Load occurs. And the resulting compression stress;

$$\sigma = \frac{P_b D_m}{2}$$

Under the external pressure, pipes should also be inspected in case of buckling.

$$\sigma_b = \frac{2E}{1-\nu^2} \left[\frac{s}{D_m} \right]^2$$

The pressure that forms the stress in the formula,

$$P_b = \frac{2E}{1-\nu^2} \left[\frac{s}{D_m} \right]^3$$

Burada;

E : Elasticity Module
 ν : Poisson's ratio
s : Wall thickness
 D_m : Mean diameter



Water Hammer

The velocity change of the flowing water in the pipe causes fluctuations in pressure. Velocity change on the pressure.

$$\Delta p = c \frac{\Delta v}{g}$$

D: Inner Diameter
K: Bulk modulus of the pipe wall (377)
 Δv : The velocity change
 Δp : The pressure change
c: Speed of sound in the water

Pressure in case of suppression

$$H_{max} = H_{i\phi} + \Delta p$$

Pressure in case of depression

$$H_{min} = H_{i\phi} - \Delta p$$

In order to calculate C

$$c = \sqrt{\frac{9900}{48,3 + K \frac{D}{s}}}$$

In the other water hammer calculation methods, the sound velocity in the water

$$c = \sqrt{\frac{E_p g / \gamma}{\frac{E_p}{E_w} + \frac{D_m}{s}}}$$

E_w : Modulus of Elasticity of the water
 E_p : Modulus of Elasticity of the pipe material
 γ : Specific gravity of the water
 D_m : Mean diameter
s : Wall thickness
g : Acceleration of gravity (9,81 m/s²)
 ν : Poisson's ratio

$$E_p : \text{For buried pipes } \frac{E_p}{1-\nu^2}$$

In addition, since $\frac{E_p}{E_w} \ll \frac{D_m}{s}$

$\frac{E_p}{E_w}$ can be neglected. In this case, the formula is as follows.

$$c = \sqrt{\frac{E_p g / \gamma}{1-\nu^2} \cdot \frac{s}{D_m}}$$

Thermal Expansion - Linear

When installing HDPE (PE-80, PE-100) pipes, the elongation rate due to the temperature variability must be taken into consideration. If the temperature rises there will be a longitudinal elongation and a decrease in the temperature. There will be an elongation or shortening of 0,18mm for each K amount of heat exchange (1 K=1 °C) at 1 m. of PE pipe.

$$\Delta L = L \cdot \Delta T \cdot \delta \quad (\Delta L = \text{m. K. mm/m.K})$$

Elongation Coefficient for Plastic Materials

Material	Coefficient mm/mK
HDPE	0.18
PP	0.15
PVDF	0.14
PB	0.12
PVC	0.07
GFK	0.02

For example, in case of an elongation or shortening of the length due to the heat in a line made with PE pipe, the pipe will slip from its turning point and not from its fixed point. For a 15m pipe, if the normal operating temperature is $T_v=20^\circ\text{C}$, the maximum operating temperature is $T_1=70^\circ\text{C}$ and the minimum operating temperature is $T_2=5^\circ\text{C}$ Accordingly, temperature dependent length changes are calculated as follows:

Elongation due to heat rise:
 $\Delta L = L \cdot \Delta T_1 \cdot d = 15 \times 50 \times 0,18 = 135 \text{ mm.}$

Elongation due to heat drop:
 $-\Delta L = L \cdot \Delta T_2 \cdot d = 15 \times 15 \times 0,18 = 40,5 \text{ mm.}$

$$L_s = k \cdot \sqrt{d \cdot \Delta L}$$

L_s : Fixing distance (mm.)

d : Pipe outer diameter (mm.)

k : Factor for HDPE 26, for PP 30, for PVC 33,5

For a PE pipe with a diameter of $\varnothing 50 \text{ mm.}$
 $\Delta L = 135 \text{ mm.}$ and the factor is 26 Clip distance
 $L_s = 26 \cdot \sqrt{50 \cdot 135} = 2136,12 \text{ mm.}$

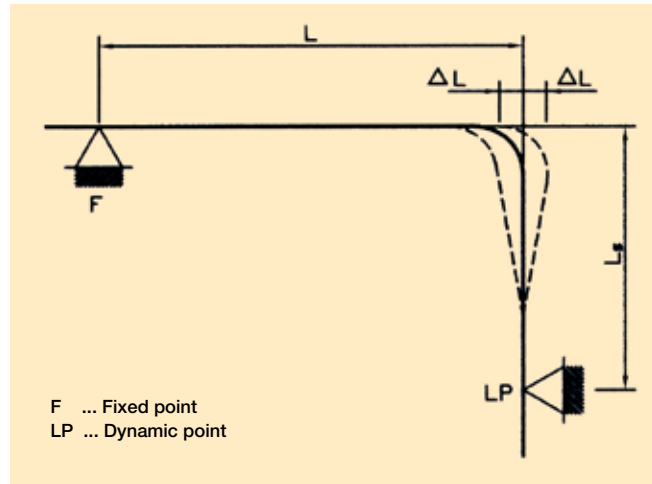

Figure 13: Expansion areas

Flexibility

Maximum bending radius for PE pipes:

$$R = \frac{E \cdot D_m}{2 \cdot \sigma}$$

- R : Bending radius (mm)
- D_m : Mean diameter of pipe (mm)
- E : Pipe modulus of Elasticity (N/mm²)
- σ : Stress (N/mm²)

HDPE Class	Environmental Stress N/mm ²
PE 63	5
PE 80	6.3
HDPE	8

For the acceptable small bending radius, it should not be below of the values given in the following table

Pipe Raw Material	Operating temperature	Acceptable small bending radius	
		SDR 17	SDR 11
PE 80 ve PE100	20 °C	30 x da	20 x da
	10 °C	50 x da	35 x da
	0 °C	75 x da	50 x da

The probability of the fracture is critical when calculating the bending diameter for thin wall pipes.

When calculating the acceptable bending radius in thin wall pipes (considering fracture) the following formula is used.

$$RK = \frac{r_m^2}{0.28 \cdot s} \text{ (mm)}$$

- r_m : Mean radius of pipe (mm)
- s : Wall thickness (mm)

When calculating the acceptable bending radius in thick wall pipes (considering stress-shrinkage) the following formula is used.

$$R = \frac{r_a \cdot 100}{E} \text{ (mm)}$$

- r_a : Pipe outer radius (mm.)
- E : Stress-shrinkage (mm)

* Stress-shrinkage ratio should not exceed 2,5%

Bending Radius of PE pipes comparing to SDR

Pipe Type	SDR	Acceptable Bending Radius R D= Pipe Outer Diameter
1	41	50 d
2	33	40 d
3	26	30 d
4	17.6	20 d
5	11	20 d
6	7.4	20 d

For acceptable bending radius at operating temperatures below 0°C, it should be added 2,5 to the values specified in the table above. At operating temperatures between 0° and 20°C, the acceptable bending radius is determined by interpolation (ratio) method.



Buckling (Slump) Calculation in case of Negative Pressure in Buried Pipes

In case of negative pressure the buckling control of buried pipes is carried out according to ATV127. This calculation is performed in the following order.

Soil classification according to ATV 127

- Group 1: Non-cohesive soil (sand, gravel)
- Group 2: Slightly cohesive soil (non-uniform sand and gravel)
- Group 3: Cohesive mixed soil (stone flour, shredded rock, clay sand)
- Group 4: Cohesive, clay soil

Table 12: Soil Properties

Group	Density kN/m ³	Inner friction angle φ	Dpr dependent E-values at compression grade Mpa					
			85	90	92	95	97	100
G1	20	35	2	6	9	16	23	40
G2	20	30	1,2	3	4	8	11	20
G3	20	25	0,8	2	3	5	8	13
G4	20	20	0,6	1,5	2	4	6	10

Soil elasticity modulus according to the compaction proctor index Dpr.

$$E = \frac{2,74 \cdot 10^{-7}}{G} e^{0,188 D_{pr}}$$

Soil Load Calculation of soil load

$$P_e = x \cdot \gamma_B \cdot h$$

- x : Load cycling factor
- γ_B : Soil specific gravity
- h : Filling height

$$x = \frac{1 - e^{-2 \frac{h}{b} K_1 \tan \delta}}{2 \frac{h}{b} K_1 \tan \delta}$$

If the trench is bevelled

$$x_{\beta} = 1 - \frac{\beta}{90} + x \frac{\beta}{90}$$

- β : Slope angle (angle degree)
- K₁ : K₁ : 0,5
- δ : δ : 2/3φ

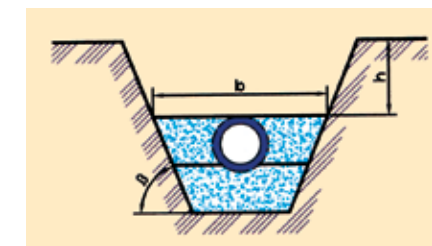

Slope Trench

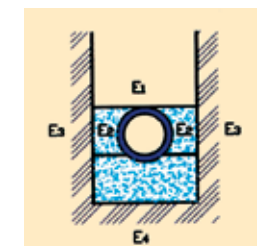

Vertical Trench

Calculation of Buckling Safety Factor

The buckling safety factor is calculated by the following formula and must be greater than 2 (safety factor due to the slump)

$$\gamma = \frac{1}{\frac{q_v}{q_{vkrit}} + \frac{P_a}{P_{akrit}}}$$

q_v : Vertical Earth Load (MPa)
 q_{vkrit} : Critical vertical earth load (MPa)
 P_a : External pressure (MPa)
 P_{akrit} : Critical external pressure (MPa)

there is external water in the P_a soil the pressure of it is added to the vacuum pressure that will occur in the sudden discharge. That is, the vacuum pressure is taken as the externally applied pressure. The following sequence is used to calculate the variables in this formula.

Critical q_v calculation

Horizontal bedding stiffness S_{Bh}

$$\Delta f = \frac{\frac{b}{d_a} - 1}{1,154 + 0,444 \left(\frac{b}{d_a} - 1 \right)} \leq 1,44$$

$$\zeta = \frac{1,44}{\Delta f + (1,44 - \Delta f) \frac{E_2}{E_3}}$$

$$S_{Bh} = 0,6 \cdot \zeta \cdot E_2$$

$$q_{vkrit} = 2\sqrt{S_{R} \cdot S_{Bh}}$$

S_R : Relative stiffness (MPa)
 S_{Bh} : Vertical bedding stiffness (MPa)



Calculation of vertical soil stress q_v

The following steps are used to calculate the vertical soil stress

$$a' = \frac{E_1}{E_2} > 0,25$$

if $a' < 0,251$ then $a' = 0,251$

$$\max \lambda = 1 + \frac{\frac{h}{d_a}}{\frac{3,5}{a'} + \frac{2,2}{\frac{E_4}{E_1} (a' - 0,25)} + \left(\frac{0,62}{a'} + \frac{1,6}{\frac{E_4}{E_1} (a' - 0,25)} \right) \cdot \frac{h}{d_a}}$$

$$\lambda_{RG} = \frac{\max \lambda \cdot V_S + a' \cdot \frac{4 \cdot K_2}{3} \cdot \frac{\max \lambda - 1}{a' - 0,25}}{V_S + a' \cdot \frac{3 + K_2}{3} \cdot \frac{\max \lambda - 1}{a' - 0,25}} \leq 4$$

$$1 \leq b / d_a \leq 4: \lambda_{RG} = \frac{\lambda_{RG} - 1}{3} \cdot \frac{b}{d_a} + \frac{4 - \lambda_{RG}}{3}$$

$$4 \leq b / d_a \leq \infty: \lambda_{RG} = \lambda_{RG} = \text{Constant}$$

$$q_v = \lambda_{RG} \cdot P_E$$

Critical P_a calculation

$$P_{akrit} = \alpha_D \cdot S_R$$

α_D It is determined from below chart.
 α_D should be calculated VRB. S_R is the relative stiffness.

$$V_{RB} = \frac{S_R}{S_{Bh}}$$

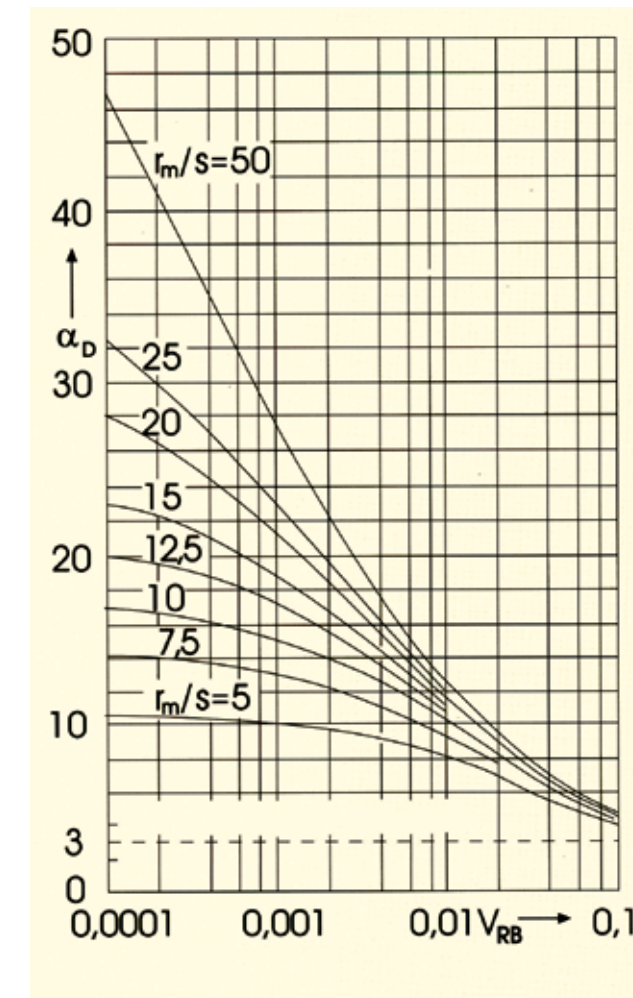

α_D Curve chart

Calculation of S_r Relative Stiffness

The relative stiffness in the pressure lines depends on the mean radius, the wall thickness and the modulus of elasticity of the material.

$$S_R = \frac{EI}{r_m^3}$$

E : Pipe modulus of Elasticity (Pa)
 I : The moment of inertia of the pipe section (m^4/m)
 r_m : Mean radius (m)
 S_R : Relative stiffness (Pa)

The moment of inertia of the pipe section is

$$I = \frac{s^3}{12}$$

s : Pipe wall thickness (m.)
 r_m : Mean radius

$$r_m = \frac{r_d + r_i}{2}$$

r_i : Inner radius (m)
 r_d : Outer radius (m)



Hydraulic Calculation Principles

Roughness Coefficients

William - Hazzen: 149
 Colebrooke - White: 0,02 mm.
 Darcy - Weissbach: 0,02 mm.

Colebrooke-White Formula

$$\frac{1}{\sqrt{\lambda}} = -2 \log \left[\frac{2,51}{Re\sqrt{\lambda}} + \frac{k/D_i}{3,72} \right]$$

Reynolds says: $Re = \frac{v \cdot D_i}{\nu}$

Here;
 λ : Roughness coefficients
 Re : Reynolds number
 k : Roughness (m .)
 Di : Inner Diameter
 v : Velocity (m/s)
 ν : Kinematic viscosity for 20°C water 1x10⁻⁶ (m²/s)

Q : V.A

Q: Flow rate (lt/s)
 V: Flow Velocity
 A: Cross Section (mm²)

William - Hazzen Formula

$$v = 0,85 \cdot CR^{0,63} \cdot J^{0,54}$$

$$Q = 0,278748 \cdot CD^{2,63} \cdot J^{0,54}$$

Here;
 v : Velocity (m/s)
 Q : Flow rate (m³/s)
 C : William - Hazzen coefficient
 R : Hydraulic radius (equal to D/4) (m.)
 J : Hydraulic slope (m/m)

Darcy - Weisbach Formula

$$J = \lambda \cdot \frac{L}{D_i} \cdot \frac{v^2}{2g}$$

J : Hydraulic loss
 λ : Roughness coefficient
 Di : Inner Diameter (m)
 v : Velocity (m/s)
 g : Acceleration of gravity (9,81 m/s²)

PE100 Pipes Laying Section

Notes:

- 1- **FINAL BACKFILL:** Compressed normal filler,
 - 2- **INITIAL BACKFILL:** Compressed soil filler free of harmful substances such as stone,
 - 3- **BEDDING LAYER:** (Compressed sand)
- b** : Trench width (cm)
y : Bedding layer (cm)
H : Trench depth
H_{top} : Distance between the ground to the top of the pipe (cm) (should be min. 50cm)
D : Pipe outer diameter (cm.)
2a : Bedding angle in terms of degree

If D<600 mm then y= 20 cm. b= D+2x20 cm.
 If 600 mm.<D<1000 mm. y= 20 cm. b= D+2x30
 D>1000 mm. then y= 30 cm. b= 2+2x30 cm.

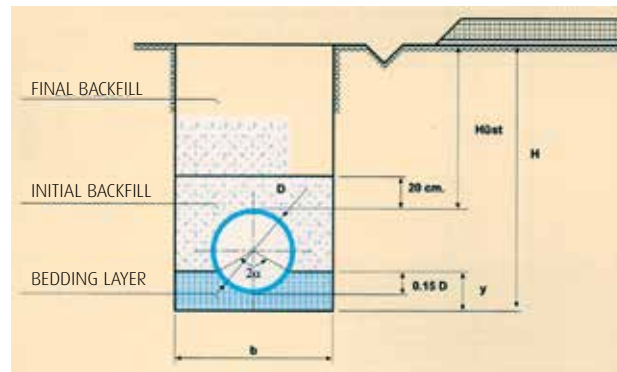

Transport and storage of PE100 pipes



It is important to transport and store polyethylene pipes and fittings in all types of installation. Although PE pipes types have different properties in terms of hardness, transportation and storage methods are same. Although polyethylene is not resistant to sharp objects, it is a durable, flexible material that is light and easy to carry. For that reason, care must be taken for cutting objects during the transportation. Signs and markings to be written on the outer surface of the pipe shall not affect the pipe wall thickness. Damaged pipes should not be used.

In general, polyethylene is not affected by low air temperatures however; since they have a smooth surface pipes and fittings become slippery in humid or freezing weather. In addition, if the fittings with large diameters have been prepared before the pipe more attention should be paid if this type of weather storage is involved. The products should be kept in their entirety until they are used with their protective packages.

If the products are to be stored outdoors for a long time, they should be covered with awning or black polyethylene cover to protect them from ultraviolet rays. In order to store under hygienic conditions, exposed ends of the pipes should be also be covered to protect them from sewage, foreign material (soil,

Transportation

- If the load to be carried is bulky, care must be taken that the load-bearing part of the vehicle is sufficiently flat and clean, and that the load is kept away from sharp and cutting objects.
- During the installation of pipes and fittings, care should be taken for not placing the products near or adjacent to heat-releasing and heat-dissipating sources, and to keep them away from contaminants such as oil.
- During the transportation of the products make sure that the metal chains or hangers do not come into direct contact with the products. Curtain pedestals made of polypropylene or nylon are recommended.
- When transporting small fittings, care must be taken to ensure that the ends of the fittings do not rub against each other.
- In case of horizontal transportation, although special arrangements are required the pipes in the form of ties can be shipped both horizontally and vertically.

Handling and Storage of Frame Bundle Pipes

- In case of handling the frame bundle pipes by crane, wide non-metallic straps or ropes should be used.
- The distance among the load-bearing suspension arms of pipes having a length more than 6 meters must be at least a quarter of the length of the pipe or packaging.
- Do not use chains or hooks for carrying.
- When handling make sure that the arm hangers are positioned at equal intervals to the center of the pipe ties. (See Figure 2)
- The handling of tie packages of standard pipes with 6 meters of length by forklift is possible due to the natural structure of these pipes.
- In case of clustered packages of pipes with more than 6 meters in length, at least four-leg sling or plank supported and suitable arm cranes must be used during unloading. The same method should be used if pipes are unloaded one by one. If the unloading is done on a flat surface, it may be more practical to use skids and rope slings. (See Figure 3)

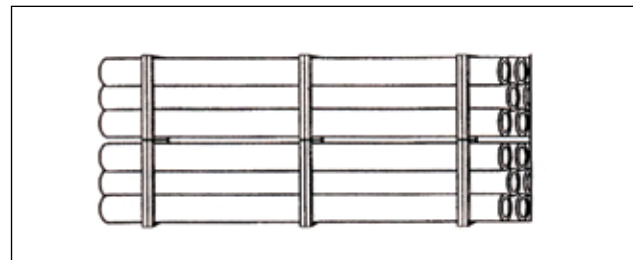

Figure 1: Typical frame bundle of PE pipes

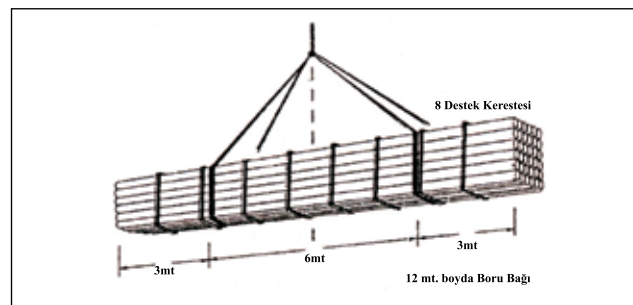

Figure 2: Carrying by crane the frame bundles

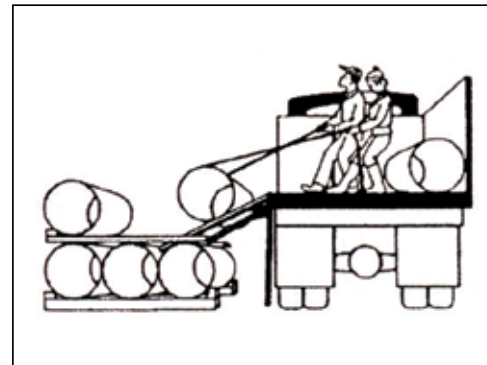

Figure 3: Unloading using timber slide.

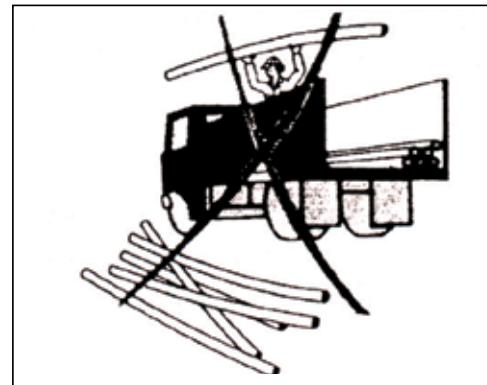

Figure 4,5: Improper unloading

Pipes should never be discharged by throwing them out of the transport vehicle or by opening and sliding the rear covers of the moving vehicle. (Figure 20)

Handling and Storage of Coil Pipes

Points to be considered

When the coil pipes are wrapped they contain a potential energy, which can cause serious accidents if not maintained in the correct conditions.

In order to ensure a safe working environment, large-diameter coil pipes must only be installed by qualified personnel.

When unwinding coil pipes, the ends must always be opened in a controlled manner and not all ties should be opened at the same time.

Since such operations involve risks, persons in these operations should wear thick hats, gloves, safety shoes and eye protection during the assignment.

Before shipment, it must be ensured that the coil pipe ends are sufficiently secured.

The adhesive roll tape to be used for coil pipe winding must be at least 2 centimetres thick (or Polyester corded strapping can be used.)

As shown in Figure 4 the roll tape should not be used only after the winding is finished, but also during the winding occasionally using the package should be brought to a safe position.

Adhesive roll tapes should not be opened until the use of coil pipes.

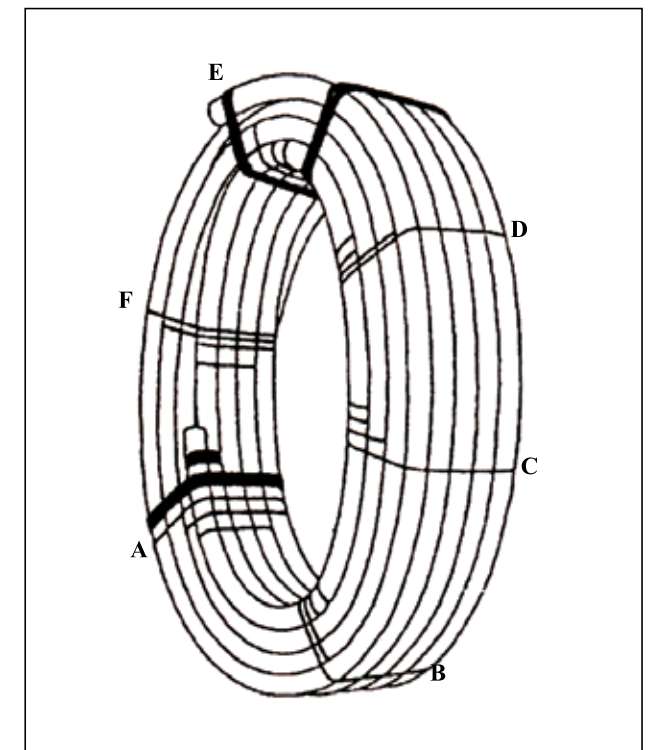

Opening of Coil Pipes Wrapped with Tape

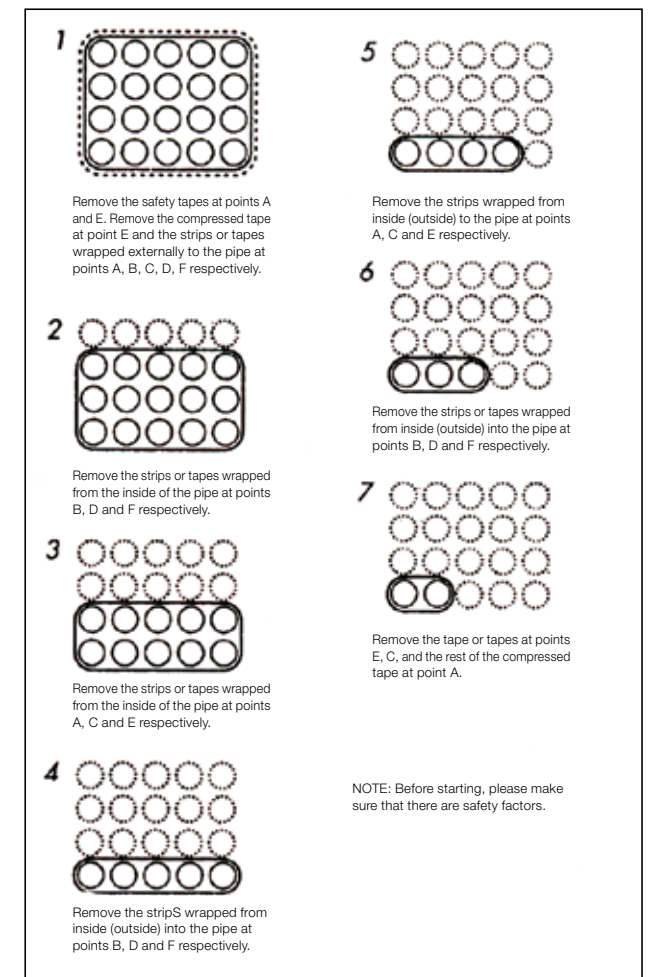

Figure 6: Opening of Coil Pipes Wrapped with Tape

Fittings

Hooks should not be used for handling of fittings usually packed in carton boxes or polyethylene bags. The heating parts of the welding machines to be used for the installation of fittings with a size of 180mm and above have simple carrying handles to prevent touching during the handling and assembly.

Warehouse Storage

All materials should be carefully inspected during the transportation and all defective materials should be set aside before the shipment is accepted to the warehouse. Any defects on the materials must be reported to the supplier immediately prior to the acceptance.

Where same products are supplied from different suppliers, these products must be maintained separately and clearly distinguishable.

Pipes and fittings must be used in order of shipment received to verify stock rotations.

Polyethylene pipes with the date of manufacture written on them by the manufacturer should be taken and during the usage the pipes with the old production date should be used first to verify the stock rotations.

Polyethylene pipes should be stored under protection and protected from direct sunlight until the use of pipes. If the conditions require the pipes to be stored in an open environment, the opaque (non-transparent) covers must be covered on the pipes.

In order to be stacked in a healthy way for the stacked pipes, the company should provide a flat floor that can meet the pipe weights, have the necessary transport equipment, keep the stacking heights to a minimum, and provide a designated area where the transport machines can easily maneuver without causing an accident. For the convenience and safety of the transport, the height of the pipe bundles in the stack of pipes shall not be more than 3 meters. In order to prevent deformations on the pipes, the pipe pallets should be stacked as shown in figure 6.

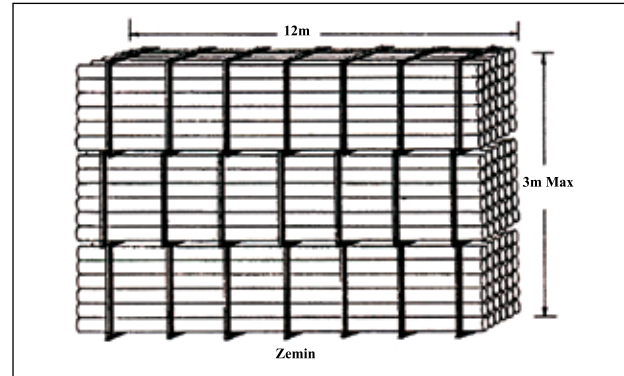

Figure 6: Storage of frame bundles

For similar reasons, pipe coils should be stacked on a flat surface as shown in figure 7 and the number of coils in each cluster should be ordered as in the table.

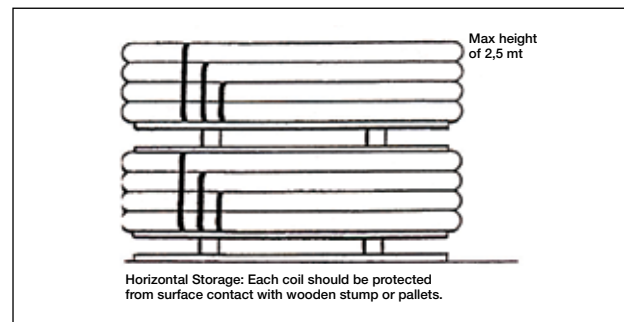

Figure 7: Diameter/Coil ratio

DIAMETER (mm)	P 100 (Coil)	PE 32 (Coil)
20	8	7
25	8	7
32	7	6
40	6	5
50	6	5
63	5	4
75	5	4
90	4	4
110	4	3

If the pipes are stacked together by forming a pyramid shape, the pipes remaining on the lower floors may deform in humid weather. Therefore, the height of such pipe clusters should not exceed 1-2 meters.

In order to prevent irregular stacking and the possibility of collision, the socketed parts of the pipes should not be brought together when stacking pipes. Pipe sides without socket should not also be brought together.

Polyethylene fittings should be stored on the shelf and under a cover. The protective packaging or carton boxes used by the manufacturer must be kept fully until the product is used.

Polyethylene pipes and fittings should always be stored away from the exhaust outlets and all other high-temperature sources.

Polyethylene pipes and fittings must not be allowed to come into contact with oil-operated materials, hydraulic oils, gases, solvents and other spreadable chemicals.

All special tools and equipments related to the joints of polyethylene pipes and fittings must be stored separately in a safe place until the use of them.

The heating part of the welding tools must be kept so that they cannot be scratched and damaged.



Outdoor Storage

In some important projects, an additional warehouse equipped with employees or safety factors may be used. It is common to store pipes and materials at selected locations close to the operation sites when working in medium-sized projects or in a clogged area. In smaller projects, if it must be operated in a very limited working area in rural areas stacking pipes by connecting to each other is also acceptable. However, following conditions should be observed in all cases.

* Securing all materials and equipment against theft, accident, damage or pollution.

* Safeguarding pedestrians, especially children and visually impaired people.

* Movement of traffic, construction equipment, agricultural machinery and animals.

All types of pipe storage must be on a suitable location, away from potentially damaging materials, and in a suitable location on the site so that construction vehicles and/or transport equipment can easily access and exit.

In case PE pipes are stacked by connecting to each other in the open area, there should not be any extra space between the pipes and the pipes should be brought together as much as possible and then stacked. If necessary, protective barriers with detailed warning signs and lamps should be erected around the stacks of pipes.

If pipes and fittings are to be kept in the open area for a long time, they should be covered with awning or black polyethylene cover to protect them from the sunlight (ultraviolet)

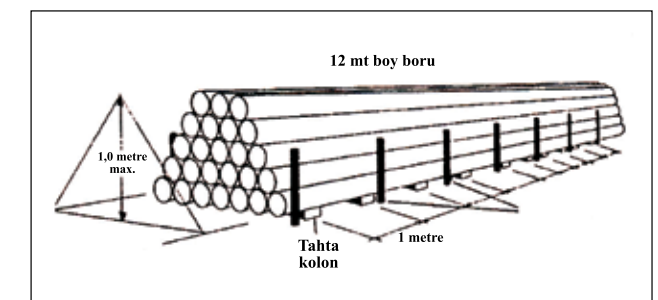

Figure 8: Outdoor Storage

Resistance of HDPE Material to Chemicals

Table 14: Resistance of HDPE Material to Chemicals

KİMYASAL ADI	KONS.	20°c'de			60°c'de		
		Dayanıklı	Az Dayanıklı	Dayanısız	Dayanıklı	Az Dayanıklı	Dayanısız
Acetaldehyde	%100	+				*	
Acetic acid	%60	+			+		
Acetic acid	%96	+				*	
Acetic anhydride	%100	+				*	
Acetone	%100		*			*	
Allyl alcohol	%96	+			+		
Ammonium hyroxide	%10	+			+		
Ammonium hyroxide	%30	+			+		
Amly acetate	%100		*			*	
Amly alcohol	%100	+				*	
Aniline	%100	+				*	
Antimony (III) Chloride	%90	+			+		
Asorbic Acid	%10	+			+		
Benzaldehyde	%100	+				*	
Benzene	%100		*			*	
Benzsulphonic acid	%10	+			+		
Bleach Iye	%10	+			+		
Butandiol	%100	+			+		
Butane gas	%100	+			+		
Butanol	%100	+			+		
Butly acetate	%100	+				*	
Butly alcohol	%100	+			+		
Butylene glycol	%100	+			+		
Butyric acid	%100	+				*	
Calcium bromate	%10	+			+		
Calcium chromate	%40	+			+		
Calcium carbonate		+			+		
Calcium nitrate		+			+		
Calcium oxide		+			+		
Cyclohexaonal	%100	+				*	
Decahydronaphthalene	%100	+				*	
Dichloropropylene				-			-
Detergents, synthetic		+			+		
Dioxan	%100	+			+		
Ethandiol	%100	+			+		
Ethanol	%40	+				*	
Ethanol	%96			-			-
Ethyl alcohol	%35	+			+		
Ethyl alcohol	%100	+			+		
Fuorine gas	%100			-			-
Formaldehyde	%40	+			+		
Formic acid	%98	+			+		
Gasoline			*			*	
Gelatine		+			+		
Glycerine	%100	+			+		
Glycerol	%100	+			+		
n-Heptan	%100		*				-
Hydrobromic acid	%50	+			+		

In TS11448, HDPE materials are resistant to chemicals.

Table 14: Resistance of HDPE Material to Chemicals

KİMYASAL ADI	KONS.	20°c'de			60°c'de		
		Dayanıklı	Az Dayanıklı	Dayanısız	Dayanıklı	Az Dayanıklı	Dayanısız
Hydrochloric acid	%40	+			+		
Hydrocyanic acid	%10	+			+		
Hydrofluoric acid	%60	+				*	
Hydrogen	%100	+			+		
Hydrogen peroxide	%30	+			+		
Hydrogen peroxide	%90	+					-
iso octane	%100	+				*	
İsoproply ether	%100	+					-
Lactic acid	%100	+			+		
Methanol	%100	+			+		
Methly alcohol	%100	+			+		
Mercury		+			+		
Naphtha			*				-
Naphthalene		+				*	
Nitrik acid	%25	+			+		
Nitrik acid	%70	+					
Nitrik acid	%100			-			-
Orthophosforic acid	%50	+			+		
Orthophosforic acid	%95	+				*	
Ozone	%100		*				-
Phosphine	%100	+			+		
Phosphine acid	%25	+			+		
Phosphine acid	%50	+			+		
Phtalic acid	%50	+			+		
Potassium hydroxide	%10	+			+		
Potassium iodate	%10	+			+		
Potassium permanganate	%20	+			+		
Propionic acid	%50	+			+	*	
Propionic acid	%100	+					
Sea water		+			+		
Silicon oil		+			+		
Soap Solution					+		
Sodium hydroxide	%40	+			+		
Sodium hypochloride	%15	+			+		
Sulphur dioxide	%100	+			+		
Sulphur trioxide	%100			-			-
Sulphuric acid	%10	+			+		
Sulphuric acid	%50	+			+		
Sulphuric acid	%70	+				*	
Sulphuric acid	%80						-
Sodium iodate	%10	+			+		
Sulphurous acid	%30	+			+		
Tetrachloroethylene	%100			-			-
Tetrachloromethane	%100		*				-
Urea	%30	+			+		
Urine		+			+		
Water		+			+		
Xylene	%100		*				-

In TS11448, HDPE materials are resistant to chemicals.

Discover our broad portfolio at wavin.com

Water management
Heating and cooling

Water and gas distribution
Waste water drainage



Wavin is part of Orbia, a community of companies working together to tackle some of the world's most complex challenges. We are bound by a common purpose: To Advance Life Around the World.



WAVIN ASIA PACIFIC E-mail wavinapac@wavin.com | Internet www.wavin.com/asia



Wavin operates a programme of continuous product development, and therefore reserves the right to modify or amend the specification of their products without notice. All information in this publication is given in good faith, and believed to be correct at the time of going to press. However, no responsibility can be accepted for any errors, omissions or incorrect assumptions.

© 2020 Wavin Wavin reserves the right to make alterations without prior notice. Due to continuous product development, changes in technical specifications may change. Installation must comply with the installation instructions. All rights reserved. No part of this book may be reproduced, reprinted or utilized in any form or by any means, whether electronic, mechanical, by photocopies, recordings, or other means, now known or hereafter invented, without prior written permission from the publisher.