

## Wavin UK (Holdings) Ltd

Crow Edge  
Hazlehead  
Sheffield  
South Yorkshire S36 4HG  
Tel: 01709 856300 Fax: 01709 856301  
e-mail: info@wavin.co.uk  
website: www.intesio.co.uk



Agrément Certificate  
**03/4018**  
Product Sheet 1

## INTESIO ATTENUATION AND INFILTRATION SYSTEMS

### AQUACELL CORE ATTENUATION AND INFILTRATION SYSTEM

#### PRODUCT SCOPE AND SUMMARY OF CERTIFICATE

This Certificate relates to the AquaCell Core Attenuation and Infiltration System, which can be used either for sub-surface water storage or as a soakaway to manage run-off from impermeable surfaces.

#### AGRÉMENT CERTIFICATION INCLUDES:

- factors relating to compliance with Building Regulations where applicable
- factors relating to additional non-regulatory information where applicable
- independently verified technical specification
- assessment criteria and technical investigations
- design considerations
- installation guidance
- regular surveillance of production
- formal three-yearly review.

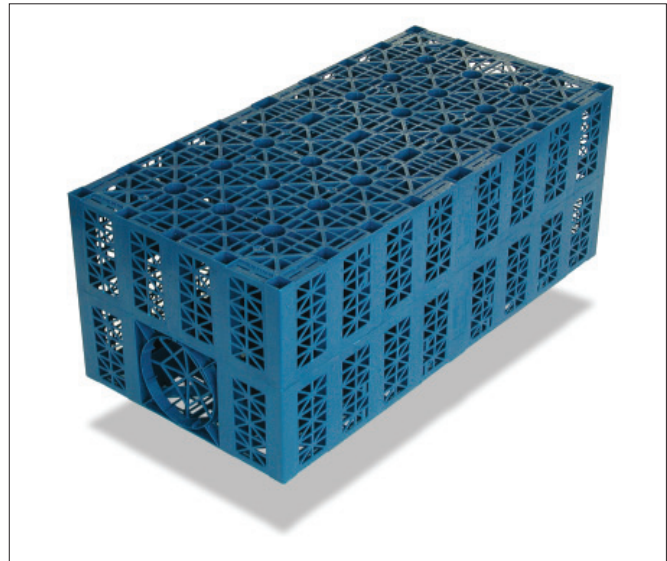

#### KEY FACTORS ASSESSED

**System design** — data is provided in the Certificate to assist in the design of a stormwater management system (see section 5).

**Structural performance** — the system has adequate strength and stiffness to resist long- and short-term loads when used in accordance with this Certificate (see section 6).

**Durability** — the system will have a service life in excess of 50 years when installed in accordance with this Certificate (see section 11).

The BBA has awarded this Agrément Certificate to the company named above for the system described herein. The system has been assessed by the BBA as being fit for its intended use provided it is installed, used and maintained as set out in this Certificate.

On behalf of the British Board of Agrément

Brian Chamberlain  
Head of Approvals — Engineering

Greg Cooper  
Chief Executive

Date of First issue: 9 June 2010

Originally certified on 28 March 2003

Certificate amended on 22 July 2010 to clarify annotation in Figure 5.

*The BBA is a UKAS accredited certification body — Number 113. The schedule of the current scope of accreditation for product certification is available in pdf format via the UKAS link on the BBA website at [www.bbacerts.co.uk](http://www.bbacerts.co.uk)*

*Readers are advised to check the validity and latest issue number of this Agrément Certificate by either referring to the BBA website or contacting the BBA direct.*

British Board of Agrément  
Bucknalls Lane  
Garston, Watford  
Herts WD25 9BA

©2010

tel: 01923 665300  
fax: 01923 665301  
e-mail: mail@bba.star.co.uk  
website: [www.bbacerts.co.uk](http://www.bbacerts.co.uk)

# Regulations

In the opinion of the BBA, the AquaCell Core Attenuation and Infiltration System, if used in accordance with the provisions of this Certificate, will meet or contribute to meeting the relevant requirements of the following Building Regulations:



## The Building Regulations 2000 (as amended) (England and Wales)

Requirement:	H3(3)	Rainwater drainage
Comment:		The units can be used in a construction to meet this Requirement. See sections 5.1 to 5.10 of this Certificate.
Requirement:	Regulation 7	Materials and workmanship
Comment:		The system is acceptable. See section 11 and the <i>Installation</i> part of this Certificate.



## The Building (Scotland) Regulations 2004 (as amended)

Regulation:	8(1)(2)	Fitness and durability of materials and workmanship
Comment:		The use of the system satisfies the requirements of this Regulation. See sections 10.1 to 10.6, 11 and the <i>Installation</i> part of this Certificate.
Regulation:	9	Building standards — construction
Standard:	3.6(a)	Surface water drainage
Comment:		The units can be used in a construction to satisfy this Standard, with reference to clauses 3.6.1 <sup>(1)(2)</sup> to 3.6.5 <sup>(1)(2)</sup> . See sections 5.1 to 5.10 of this Certificate. (1) Technical Handbook (Domestic). (2) Technical Handbook (Non-Domestic).



## The Building Regulations (Northern Ireland) 2000 (as amended)

Regulation:	B2	Fitness of materials and workmanship
Comment:		The system is acceptable. See section 11 and the <i>Installation</i> part of this Certificate.
Regulation:	B3(2)	Suitability of certain materials
Comment:		The system is acceptable. See sections 10.1 to 10.6 of this Certificate.
Regulation:	N5	Rain-water drainage
Comment:		The system can be used in a construction to satisfy this Regulation. See sections 5.1 to 5.10 of this Certificate.

## Construction (Design and Management) Regulations 2007

## Construction (Design and Management) Regulations (Northern Ireland) 2007

Information in this Certificate may assist the client, CDM co-ordinator, designer and contractors to address their obligations under these Regulations.

See sections: 2 *Delivery and site handling* (2.3) and 13 *Installation — Procedure* of this Certificate.

# Non-regulatory Information

## NHBC Standards 2008

In the opinion of the BBA, the use of the AquaCell Core Attenuation and Infiltration System, in relation to this Certificate, is not subject to the requirements of these standards.

# General

This Certificate relates to the AquaCell Core Attenuation and Infiltration System, consisting of polypropylene units, shear connectors and clips.

The system assembles to form an underground structure which can be used either for sub-surface water storage or as a soakaway to manage run-off from impermeable surfaces.

This Certificate does not cover the collection or disposal of the surface water. Information relating to this can be obtained from the Certificate holder.

## 1 Description

1.1 The AquaCell Core Attenuation and Infiltration System consists of individual, blue polypropylene modular units (see Table 1), black polypropylene shear connectors and black polypropylene clips (see Figure 1).

Table 1 Characteristics of modular unit

Element (Unit)	Value
Dimensions (nominal) (l x w x h) (mm)	1000 x 500 x 400
Volume (nominal) (m <sup>3</sup> )	0.20
Storage volume (nominal) (m <sup>3</sup> )	0.19
Porosity (void ratio) (%)	95
Ultimate compressive strength at yield (kN·m <sup>-2</sup> )	
– vertical loading on top face	560
– lateral loading on side face	77.5
Short-term deflection (mm per kN·m <sup>-2</sup> ) <sup>(1)</sup>	
– vertical loading on side face	1 per 97
– lateral loading on side face	1 per 7
Estimated long-term deflection <sup>(2)</sup> (Ln) <sup>(3)</sup> (mm)	0.4705

(1) Applied load.

(2) At up to 20 years at 20°C at 141 kN·m<sup>-2</sup> load.

(3) Time in hours.

Figure 1 Components

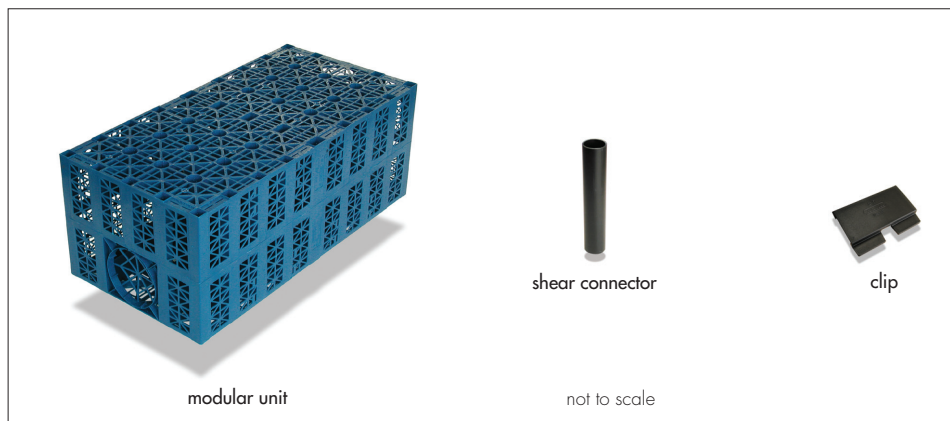

1.2 The system manages stormwater run-off from impermeable surfaces by:

- infiltration, ie as a soakaway to infiltrate water back into the ground
- attenuation, ie as temporary storage for excess flows and to control outflow to streams and rivers
- a combination of the above methods.

1.3 The polypropylene modular units have pre-formed sockets to enable connection with 160 mm diameter pipework. Alternatively, connection to 150 mm pipework is possible using an adaptor. Connection can also be made, at points other than the pre-formed sockets, to suitable 150 mm pipework using a flange adaptor. Adaptors and connecting pipework for use with this system are outside the scope of this Certificate.

1.4 Each assembly is wrapped in either a permeable geotextile when used for infiltration or an impermeable geomembrane when used for attenuation. Geotextiles and geomembranes for use with the system are outside the scope of this Certificate. Information on their required specification may be obtained from the Certificate holder.

1.5 Adequate venting must be provided to the structure using an air vent. One 110 mm diameter air vent is required per 7500 m<sup>2</sup> of impermeable catchment area to be drained. Air vent connections and pipework for use with this system are outside the scope of this Certificate.

## 2 Delivery and site handling

2.1 The system is supplied to site in packs of 15 units, secured with straps with plastic feet attached to the underside to enable placing and movement by a fork-lift. Each pack of units carries a label bearing the Aquacell type, part number, operator's initials, individual pallet sequential number and date of manufacture.

2.2 Each unit is supplied with two shear connectors and three clips.

2.3 The packs of the units should be carefully placed on level ground and should not be stacked on site. Loose individual modules should not be stored more than two units high.

2.4 The units contain an inhibitor to resist the effects of ultraviolet light for up to six months. However, prolonged exposure to direct sunlight should be avoided.

2.5 Units should not be stored near fuel bowsers, fuel tanks or areas where solvents may be kept.

2.6 The units are resistant to damage that could occur with normal handling. They should be stored away from the possibility of impacts by vehicles and other construction plant.

## Assessment and Technical Investigations

The following is a summary of the assessment and technical investigations carried out on the Aquacell Core Attenuation and Infiltration System.

## Design Considerations

### 3 General

3.1 The AquaCell Core Attenuation and Infiltration System design must be in accordance with the Certificate holder's *Stormwater Solutions – Design Manual*. Guidance on the application of sustainable drainage systems (SUDS) for new developments, such as the AquaCell Core Attenuation and Infiltration System, can also be found in the Communities and Local Government Planning Policy Statement PPS25 *Development and Flood Risk* and *The SUDS Manual C697* published by the Construction Industry Research and Information Association (CIRIA).

3.2 The system can be used for the control of stormwater run-off from impermeable surfaces in three main ways:

- Infiltration — water is collected in the units during rainfall and allowed to drain away by soaking into the surrounding ground over a period of time
- Attenuation — water is collected in the units during rainfall and released at a reduced flow rate through a flow control device into an appropriate outfall. This reduces peak flows in the watercourse, thereby minimising the risk of flooding
- Combined — a combination of the above two systems.

3.3 Design of the appropriate system (see Figure 2 and Table 2) for a specific project must always be preceded by a detailed audit of the proposed site to establish:

- existing factors and considerations applicable to the site
- predicted factors relating to the site's use following the planned development, and the parameters within which the installation is required to function
- the type of function of application suggested by this audit.

3.4 Once the project criteria have been established from the site audit, there are two main parts to the design procedure: hydraulic design and structural design.

Figure 2 Aquacell unit selection flowchart<sup>(1)(2)</sup>

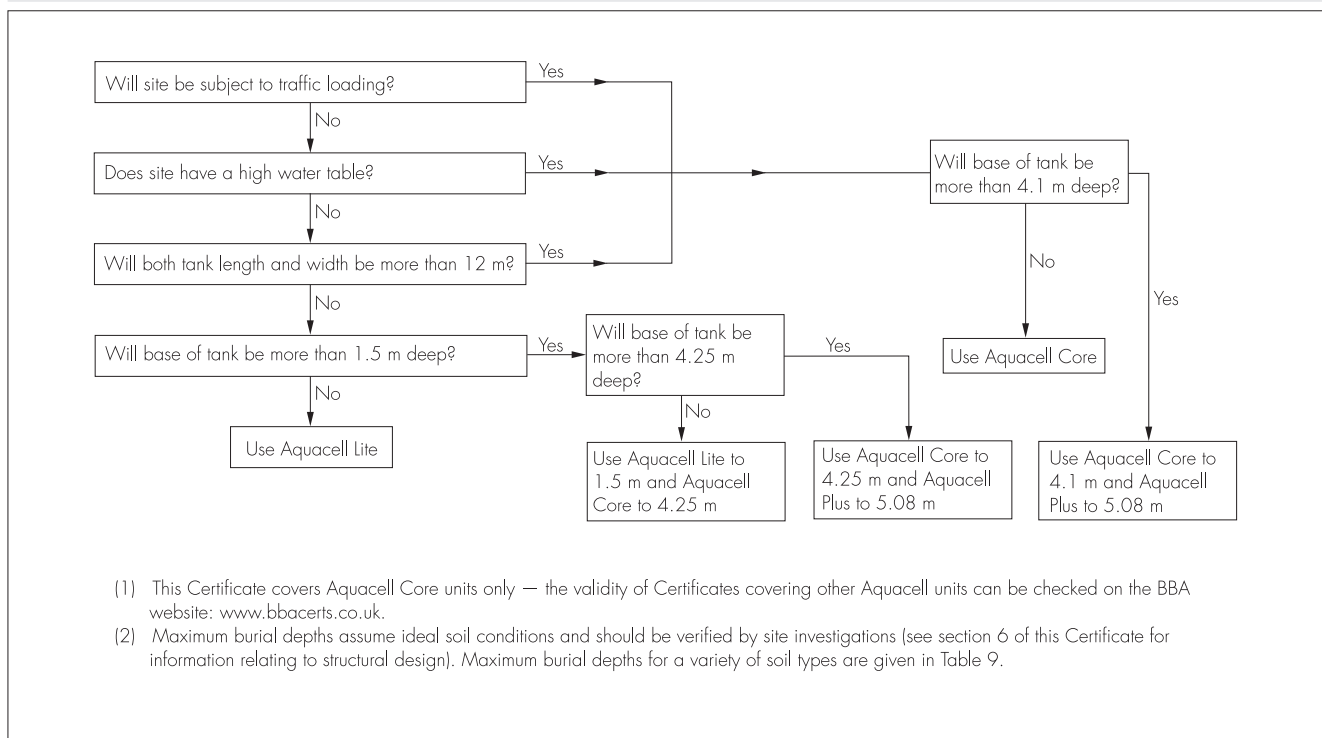

(1) This Certificate covers Aquacell Core units only — the validity of Certificates covering other Aquacell units can be checked on the BBA website: [www.bbacerts.co.uk](http://www.bbacerts.co.uk).

(2) Maximum burial depths assume ideal soil conditions and should be verified by site investigations (see section 6 of this Certificate for information relating to structural design). Maximum burial depths for a variety of soil types are given in Table 9.

**Table 2 Design information checklist**

Description	Information source
<b>A Existing factors</b>	
Topography	Site survey or inspection
Area of catchment <sup>(1)</sup>	Site survey
Hydrology of catchment	Site inspection and observations
Soil type <sup>(1)</sup>	Site investigation
Structural properties of soil – CBR, stiffness	Site investigation and laboratory testing
Infiltration potential of soil	Site investigation
Contamination <sup>(1)</sup>	Site investigation and desk research
Details of receiving water, watercourse/ aquifer	Environment Agency, Scottish Environment Protection Agency or water and sewerage company
Environmental sensitivity of site	Environment Agency, Scottish Environment Protection Agency or water and sewerage company
Groundwater vulnerability and source protection status	Environment Agency, Scottish Environment Protection Agency or water and sewerage company
<b>B Predicted factors</b>	
Development type and land use	Proposed development plans
Traffic loads	Proposed development plans
Rainfall data <sup>(1)</sup>	Meteorological Office or Wallingford procedure
Discharge design criteria	
– quantity	Environment Agency, Scottish Environment Protection Agency or water and sewerage company
– quality	Environment Agency, Scottish Environment
Health and safety	Protection Agency or water and sewerage company All affected parties.
<b>C Planned function</b>	
Infiltration	Conclusions from <b>A</b> and <b>B</b> audit/review
Attenuation	Conclusions from <b>A</b> and <b>B</b> audit/review.

(1) For individual house soakaways, only the items referenced for this footnote are required.

## 4 Practicability of installation

The system is designed to be installed by a competent general builder or contractor with experience of this type of system.

## 5 System design

### Infiltration

#### Calculation principles

 5.1 There are two approaches, either of which may be adopted, ie the Construction Industry Research and Information Association (CIRIA) Report 156 *Infiltration Drainage – Manual of Good Practice* or BRE Digest 365 *Soakaway Design*.

5.2 A simplified approximate approach can be used on a very small site (ie a single-house development) where detailed site infiltration rate information may not be required nor available (see Table 3). From Approved Document H of the England and Wales Building Regulations, for areas up to 25 m<sup>2</sup>, a storage volume equal to the area to be drained multiplied by 10 mm may be used. Beyond this size, design should be carried out in accordance with BS EN 752 : 2008 or BRE Digest 365. It is suggested in BS EN 752 : 2008 that a storage volume equal to 20 mm multiplied by the area to be drained may be used. In Scotland, guidance for the design of single-house soakaways is given in Mandatory Standard 3.6, clause 3.6.5<sup>(1)</sup>.

(1) Technical Handbook (Domestic).

**Table 3 Design parameters for single-house roof soakaway**

Number of units	Storage volume (m <sup>3</sup> )	Maximum area to be drained (m <sup>2</sup> )
1	0.19	19 <sup>(1)</sup>
2	0.38	25 <sup>(1)</sup>
3	0.57	28.5 <sup>(2)</sup>
4	0.76	38 <sup>(2)</sup>
5	0.95	47.5 <sup>(2)</sup>
10	1.90	95 <sup>(2)</sup>

(1) In accordance with Approved Document H.

(2) In accordance with BS EN 752 : 2008, clause NA 4.4.8.

5.3 When the BRE or CIRIA approach is used, the design volumes and areas for trench or cuboid type installations can be found in Tables 4 and 5.

*Table 4 Volumetric data per linear metre for a one-unit (0.5 m) wide trench configuration*

Number of units high	Volume (m <sup>3</sup> )	Side area (m <sup>2</sup> )	Base area (m <sup>2</sup> )
1	0.19	0.8	0.5
2	0.38	1.6	0.5
3	0.57	2.4	0.5

*Table 5 Volumetric data for 3D usage two units high*

No of units long (1 m side)	2 wide (0.5 m side)			4 wide (0.5 m side)			8 wide (0.5 m side)		
	Vol (m <sup>3</sup> )	Side (m <sup>2</sup> )	Base (m <sup>2</sup> )	Vol (m <sup>3</sup> )	Side (m <sup>2</sup> )	Base (m <sup>2</sup> )	Vol (m <sup>3</sup> )	Side (m <sup>2</sup> )	Base (m <sup>2</sup> )
1	0.76	3.20	1.00	1.52	4.80	2.00	3.04	8.00	4.00
2	1.52	4.80	2.00	3.04	6.40	4.00	6.08	9.60	8.00
4	3.04	8.00	4.00	6.08	9.60	8.00	12.16	12.80	16.00
8	6.08	14.40	8.00	12.16	16.00	16.00	24.32	19.20	32.00
10	7.60	17.60	10.00	15.20	19.20	20.00	30.40	22.40	40.00
100	76.00	161.60	100.00	152.00	163.20	200.00	304.00	166.40	400.00

5.4 For calculations, the size and volume of the units are given in Table 1. The total areas of the base and sides are required as water is absorbed through the geotextile soil interface. Storage volume is 95% of the total volume. As an example, using Table 4, for a typical linear trench 40 m long and two units deep, the volume is 0.38 by 40 = 15.2 m<sup>3</sup> and the side area 1.6 by 40 = 64 m<sup>2</sup>.

#### Attenuation

##### Calculation principles

5.5 The anticipated run-off volume (A) from the site must be estimated. The most commonly used method for evaluating storm rainfall events in the UK is the Wallingford Procedure by which the total rainfall level of storms over defined time periods ranging from five minutes up to 48 hours are assessed. The depth of water (mm) found can be multiplied by the catchment area to assess the size of attenuation systems and is normally based upon a two-hour storm of a return period appropriate for the catchment. The allowable discharge rate from the site to an appropriate outfall is established but will normally be set by the Environment Agency or Planning Authorities. The outflow volume (B) to be discharged at this rate over the two-hour period is calculated and subtracted from the run-off volume (A – B). This defines the excess volume (C) to be stored in AquaCell Core units constructed as an underground tank. The number of AquaCell Core units needed to contain this excess is calculated on the basis that the storage volume is equal to 95% of the total volume of the tank.

#### Connection

5.6 Connection is made to AquaCell Core units using a pre-formed socket and adaptor or a flange adaptor. These items are outside the scope of this Certificate. Information can be found in the Certificate holder's *Stormwater Solutions – Design Manual*.

5.7 It is recommended that all connections into storage applications (using a geomembrane) are made using a flange adaptor. Adhesive or double-sided tape should be used between the geomembrane and flange adaptor to ensure a watertight seal.

#### Manifold design

5.8 The capacity of this input pipe is limited and may be insufficient for the anticipated flow load. Therefore, the flow load may be split between a number of 150 mm diameter flow pipes or other connection arrangements used (see Figure 3). The maximum areas that can be drained according to the number of input pipes provided is given in Table 6. The calculations are based on:

- paved surfaces — two-year, three- to five-minute event
- eaves drained roofs — one-year, two-minute event
- internal gutters — 500-year, two-minute event.



Figure 3 Typical inlet connection designs

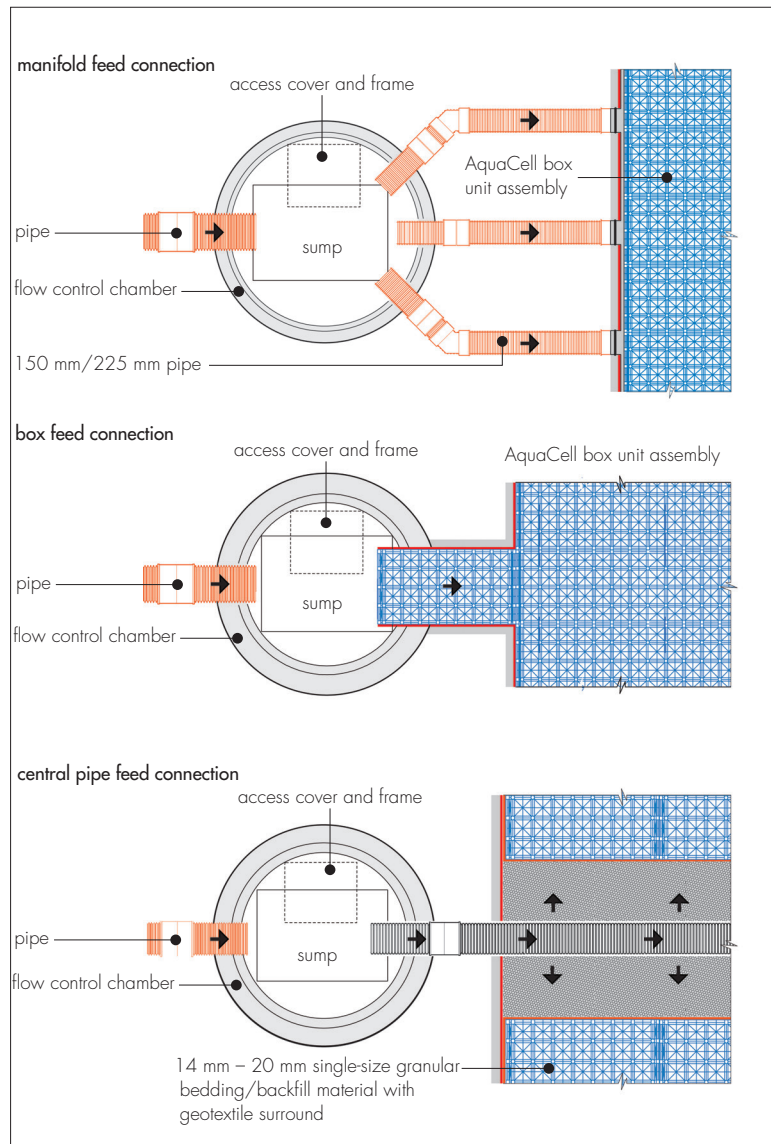

Table 6 Multiple manifolds

Surface type	Drainage area (m <sup>2</sup> )					
	Number of inlet pipes					
	1	2	3	4	5	6
Paved area	1110	2220	3330	4440	5550	6660
Roof area <sup>(1)</sup>	841	1682	2523	3364	4205	5046
Roof area <sup>(2)</sup>	210	420	630	840	1050	1260

(1) Roofs drained by eaves gutters, close to the attenuation site (within 25 m).

(2) Roofs drained by internal gutters, close to the attenuation site (within 25 m) (especially siphonic roof drainage).

## Flow control

5.9 The outflow from the tank must be controlled to comply with the discharge rate consent of the site. There are four main methods to achieve outflow control, ie orifice plate, Garastor, vortex control or small pipe. Comparative features and benefits of these various flow control devices should be considered prior to selection. These devices are outside the scope of this Certificate.

### Outflow positioning and head calculations

5.10 The invert level of the outflow pipe should be flush with, or lower than, the bottom of the lowest unit to allow the tank to drain. As the tank fills, a depth of water develops on the upstream side of the outflow control. For a tank with two layers of AquaCell Core units, this depth is 0.8 m when the units are full, creating a driving head to push the flow through the control device. For design purposes, the head used in calculations is taken as that at the centre line of the outflow device.

## 6 Structural performance

6.1 AquaCell Core units can be placed under a wide variety of landscaped or lightly-trafficked areas. Design procedures for heavily-trafficked applications are outside the scope of this Certificate. If the proposed application is in areas subject to high-intensity traffic, commercial vehicles or other heavy loads, the advice of the Certificate holder should be sought.

6.2 The short-term ultimate compressive strength at yield for the AquaCell Core units, as derived from independent test data, is  $560 \text{ kN}\cdot\text{m}^{-2}$  for vertical loading on the top face and  $77.5 \text{ kN}\cdot\text{m}^{-2}$  for lateral loading on the side face. A partial safety factor for materials ( $f_m$ ) of 2.75 for ultimate limit state and 1.5 for serviceability limit state should be applied to these values for a design life of 20 years. The short- and long-term deflections are given in Table 1.

6.3 Creep tests indicate that the long-term deflection may be estimated from the following expression. This is valid for loads up to  $141 \text{ kN}\cdot\text{m}^{-2}$  for durations of up to 20 years at  $20^\circ\text{C}$ . In locations where settlement is not a concern, designs of up to 50 years can be considered:

$$\text{deflection (mm)} = 0.4705 \ln(\text{time in hours}) + 4.0005$$

6.4 For small-scale application such as soakaways for individual house roof drainage, the AquaCell Core system is typically located below a garden a minimum of 5 m from the building (see Table 7). In this case there are no traffic loads.

*Table 7 Design criteria for use of AquaCell Core system as soakaway for individual house*

Criterion	Value
Maximum depth to base of units <sup>(1)</sup> (m)	2.95
Minimum depth of cover required over units to prevent accidental damage (m)	0.50

(1) Assumes a minimum value for the angle of shearing resistance of the surrounding soil of  $29^\circ$ . This should be confirmed from the results of the site investigation. Groundwater must be at least one metre below base of units.

6.5 AquaCell Core units used for large-scale storage or infiltration must be designed to carry all loads that will be applied, including dead and imposed loads. Design parameters and estimated loads should be used to determine the maximum depth of installation and the maximum and minimum cover depths.

6.6 The criteria provided in Tables 8 and 9 can be used to design the AquaCell Core units for installation below lightly- and non-trafficked areas. These design tables are only applicable in temperate climate conditions such as those in the UK. The partial safety factors for loads that have been applied are given in Table 10. Partial safety factors for materials ( $f_m$ ) of 2.75 for ultimate limit state and 1.5 for serviceability limit state have been applied. The AquaCell Core system can be used for areas where greater loads are anticipated but these applications are outside the scope of this Certificate and specific advice should be sought from the Certificate holder.

*Table 8 Maximum installation depths (to base of units)*

Typical soil type	Typical angle of shearing resistance <sup>(1)(2)</sup> ( $\phi$ )	Maximum depth of installation (to base of units) (m)			
		With groundwater at 1 m below ground level and units wrapped in geomembrane		Without groundwater below base of units (normal case)	
		Trafficked areas (cars only) <sup>(3)</sup>	Non-trafficked areas	Trafficked areas (cars only) <sup>(3)</sup>	Non-trafficked areas
Stiff over-consolidated clay (eg London clay)	$24^\circ$	1.65	1.75	2.35	2.50
Normally consolidated silty, sandy clay (eg alluvium, made ground)	$26^\circ$	1.70	1.80	2.50	2.65
Loose sand and gravel	$29^\circ$	1.80	1.90	2.85	2.95
Medium dense sand and gravel	$33^\circ$	1.90	2.00	3.30	3.45
Dense sand and gravel	$38^\circ$	2.05	2.15	4.10	4.25

(1) Loosening of dense sand or softening of clay by water can occur during installation. The designer should allow for any such likely effects when choosing an appropriate value of  $\phi$ .

(2) The design is very sensitive to small changes in the assumed value of  $\phi$ , therefore, it should be confirmed by a chartered geotechnical engineer. In clay soils, it may be possible to utilise cohesion in some cases.

(3) Applicable for car parks or other areas trafficked only by cars or occasional refuse collection trucks or similar vehicles (typically one per week).

Assumptions made are:

- ground surface is horizontal
- shear planes or other weaknesses are not present within the structure of the soil.



**Table 9 Minimum cover depths over top of AquaCell Core units<sup>(1)</sup>**

Location	Minimum cover depth (m)
Non-trafficked areas (eg landscaping)	0.50
Car parks, vehicles up to 2500 kg gross mass, Aquacell system up to three units wide in trench	0.60
Car parks, vehicles up to 2500 kg gross mass, Aquacell system greater than three units wide	0.75

(1) Assumes 27° load distribution through fill material and overlying surface of asphalt or block paving, and trafficking by occasional refuse collection trucks or similar vehicles (typically one per week).

**Table 10 Partial safety factors for loads used for design**

Description	Symbol	Ultimate limit state	Serviceability limit state
Vertical dead load	$f_{dl}$	1.40	1.00
Earth pressure (horizontal) dead load	$f_{ep}$	1.40	1.00
Imposed live load	$f_{ll}$	1.60	1.00

6.7 For lightly-loaded applications, the bearing capacity of the underlying soils, typically, should not be exceeded by the AquaCell Core System. Therefore, settlement of the underlying soils should be negligible. On weak or compressible soils, the bearing capacity and settlement characteristics should be confirmed by a geotechnical engineer.

6.8 Care should be taken when the AquaCell Core system is used for infiltration below trafficked areas and close to structures. It is important to ensure that the infiltrating water will not soften the soils or cause loss of fines and settlement.

6.9 When the units are wrapped in an impermeable geomembrane and placed below the groundwater table, flotation may occur. To prevent this, the weight of the soil over the top of the units must be greater than the uplift force caused by the unit's buoyancy in the water. This can be achieved with most types of fill if the depth of cover fill is equal to, or greater than, the depth of penetration of the units below groundwater level.

## 7 Geotextiles and geomembranes

7.1 In infiltration applications, the geotextile wrapped around the AquaCell Core system prevents soil entering the units and stops the soil which surrounds the unit becoming clogged with silt present in run-off. In attenuation/storage applications, the geotextile serves to protect the geomembrane.

7.2 The selection of an appropriate geotextile for a specific AquaCell Core infiltration installation should be considered carefully, with particular reference to the surrounding soil properties and required performance. Points to consider are:

- the pore size should be designed and specified to assist infiltration and prevent migration of fine soil particles
- the permeability and breakthrough head should not limit the flow of water in the system, and should be similar to or greater than the surrounding materials
- the material must be able to resist the punching stresses caused by loading on sharp points of contact
- its strength should be sufficient to resist the imposed forces (eg from traffic).

7.3 The geotextile should be selected according to specific site conditions. However, typically, a 300 g non-woven material will be suitable for most situations. Specialist advice should be sought if surrounding soil characteristics exhibit a high degree of fines/low infiltration capacity and/or there is risk of damage from ground contaminants.

7.4 In attenuation/storage applications where infiltration is not possible or permitted, an impermeable geomembrane is wrapped around the AquaCell Core system to prevent release of attenuated/stored water into surrounding ground and to prevent inflow of pollutants from contaminated subsoil into the storage reservoir.

7.5 The specification and selection of the impermeable geomembrane must be correct for the installation envisaged, to ensure it performs to the level required. It is essential that the specified material:

- withstands the rigours of installation
- resists puncture
- resists multi-axial elongation stress and strains associated with settlement
- resists environmental stress cracking
- resists damage from ground contaminants
- remains intact for the full design life.

7.6 Geomembranes less than 1 mm thick are unlikely to meet these criteria<sup>(1)</sup>, and are not recommended for use with the AquaCell Core system<sup>(2)</sup>. A specification for a typical polypropylene geomembrane is shown in Table 11.

(1) Except in shallow, domestic installations.

(2) Further details can be obtained from the Certificate holder.

Table 11 Typical specification for a polypropylene geomembrane

Property	Value	Test method
Thickness $\pm$ 10% (mm)	1.0	ASTM D 751
Density (minimum) ( $\text{g}\cdot\text{cm}^{-3}$ )	0.9	ASTM D 792
Tensile stress at break (min) ( $\text{N}\cdot\text{mm}^{-2}$ )	18	ASTM D 638
Elongation at break (%)	>700	ASTM D 638
Puncture resistance (min) (N)	150	FTMS 101C, Method 2065
Tear resistance (min) (N)	60	ASTM D 1004
Dimensional stability (max) (% change)	$\pm$ 2.0	ASTM D 1204, 1 h at 100°C
Stress crack resistance (%)	100	ASTM D 5397
Volatile loss, 5% loss (max)	0.2	ASTM D 1203
Ozone resistance	No cracks	ASTM D 1149
Carbon black content (%)	2 to 3	ASTM D 1603
Moisture vapour ( $\text{g}\cdot\text{m}^{-2}\cdot\text{day}^{-1}$ )	<0.1	ASTM E 96
Friction angle (non-woven geotextile)	21°	Shear box
Methane permeability ( $\text{g}\cdot\text{m}^{-2}\cdot\text{day}^{-1}\cdot\text{atm}^{-1}$ )	0.11	European Standard
Methane transmission rate ( $\text{m}^3\cdot\text{m}^{-2}\cdot\text{s}^{-1}\cdot\text{atm}^{-1}$ )	$0.8 \times 10^{-9}$	BRE
Permeability coefficient	$1.8 \times 10^{-12}$	
Application temperature (°C)	>4	

7.7 To ensure total impermeability, joints between adjacent sheets of impermeable geomembranes should be sealed correctly using proprietary welding techniques. The integrity of joints should be demonstrated by non-destructive testing<sup>(1)</sup>.

(1) Advice on seam testing is given in CIRIA SP124 *Barriers, liners and cover systems for containment and control of land contamination*.

## 8 Venting

8.1 Adequate venting must be provided to the AquaCell Core structure. One 110 mm diameter air vent is required per 7500 m<sup>2</sup> of impermeable catchment area to be drained (see Figure 4).

8.2 Typical air vent connectors and pipework can be seen in the Certificate holder's *Intesio Stormwater Solutions – Design Manual*. It is recommended that all air vent installations in attenuation/storage applications (using an impermeable geomembrane) are made using a flange adaptor. Adhesive or double-sided tape should be used between the geomembrane and flange adaptor to ensure a watertight seal.

Figure 4 Typical air vent system

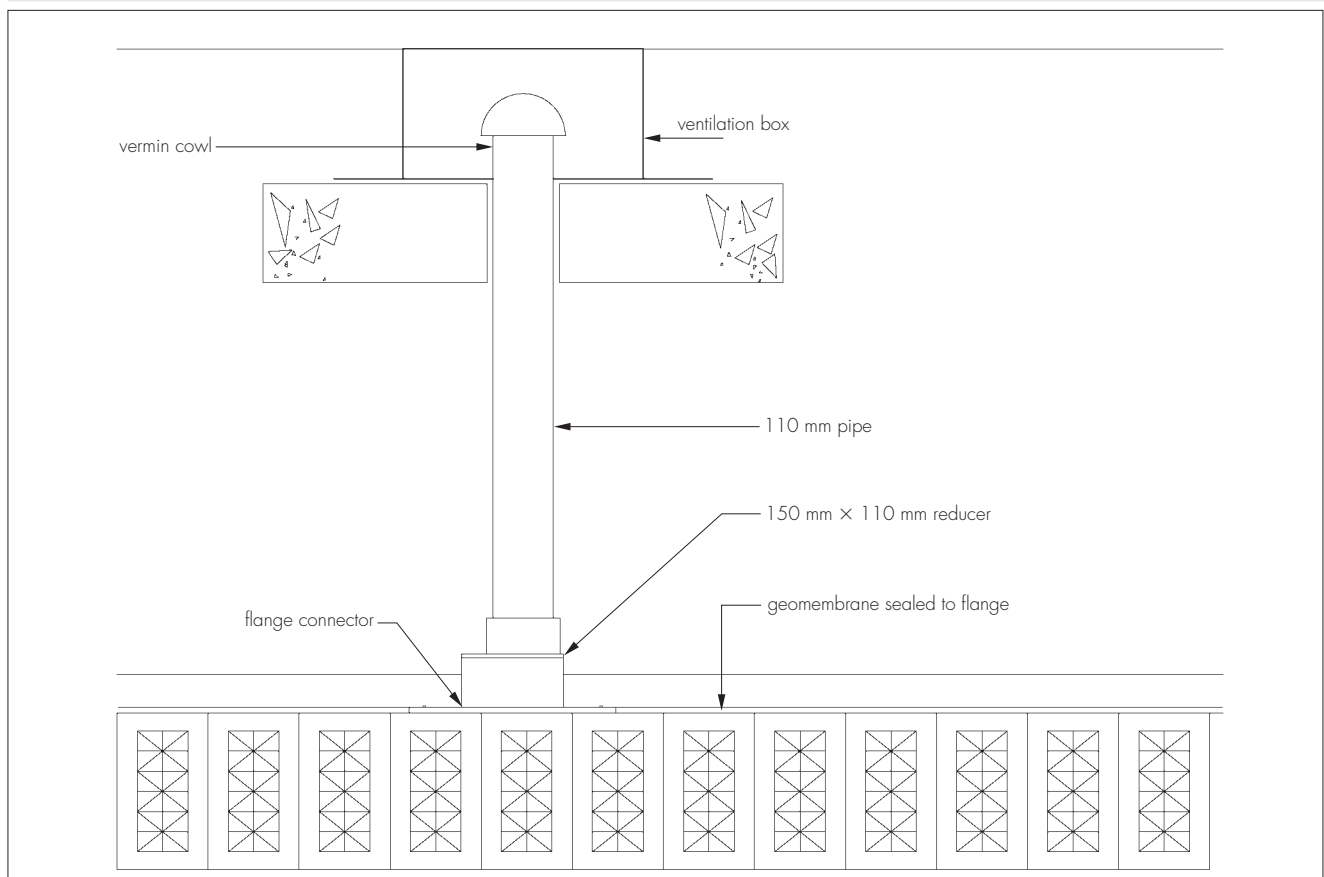

## 9 Resistance to chemicals

9.1 An assessment by the BBA indicates that the components of the system are suitable for use in contact with the chemicals likely to be found in rainwater.

9.2 An assessment of the suitability for use of AquaCell Core units on brownfield sites should be made only after a suitable site investigation to determine the possibility for chemical attack. Particular care must be taken where acids and organic solvents are present at high concentrations. Further information can be obtained from the Certificate holder.

## 10 Maintenance



10.1 The customer is responsible for maintenance. Recommendations for maintenance of SUDS systems are given in CIRIA C697.

10.2 For soakaways to individual houses, the only necessary maintenance is to keep gullies clear of debris such as leaves.

10.3 For large installations or where the receiving waters are environmentally sensitive, a system of regular inspections should be established to prevent the accumulation of silt in the system which, if allowed to develop, would reduce effectiveness. They should also be inspected after every major storm event.

10.4 It is recommended that a silt trap is incorporated into the pipework at the inlet to the tank (see Figure 5). There must be a maintenance plan that ensures regular cleaning of the trap to ensure correct performance. Silt traps for use with this system are outside the scope of this Certificate.

10.5 For all flow control devices it is sensible to incorporate access (via a manhole or similar) to the location of the pipe entry, orifice or vortex control. This will enable easy removal of any blockage. The orifice itself may be protected by a debris screen.

10.6 Paved surface areas above an installation should be inspected at the same time to ensure the units continue to provide the required structural support.

Figure 5 Typical silt trap

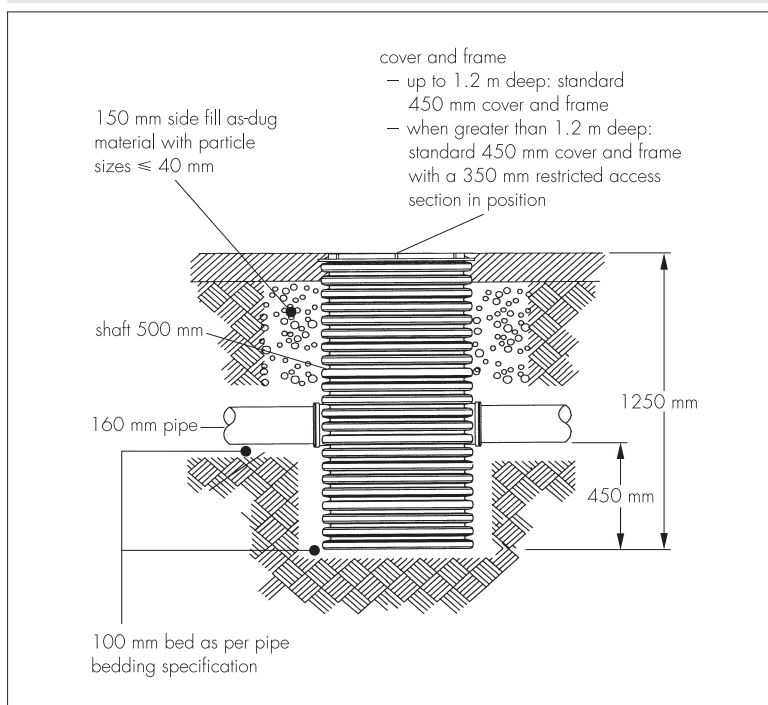

## 11 Durability



The structural properties of polypropylene used in the components of the system will deteriorate with time and should be taken into account at the design stage by the application of suitable safety factors. In the opinion of the BBA, the AquaCell Core Attenuation and Infiltration System, when used in accordance with this Certificate, will have a life in excess of 50 years.

### 12 General

The system should be installed in accordance with the Certificate holder's *Stormwater Solutions — Design Manual*.

### 13 Procedure

13.1 The hole or trench is excavated to the required depth, dimensions and levels. It must be ensured that the plan area is sufficient to allow plant access around sides to compact backfill material (300 mm minimum). The base must be smooth and level without sharp drops or humps. Slopes must be cut to a safe angle or adequately supported and safe access must be provided to allow personnel to enter the excavation.

13.2 The base must be inspected for soft spots in the formation – any present must be excavated and replaced with compacted granular fill material.

13.3 A 100 mm thick, bedding layer of coarse sand is laid on the base and sides of the excavation. If required in attenuation systems, a layer of geotextile is laid to protect the impermeable geomembrane.

13.4 The impermeable geomembrane (or geotextile, if in an infiltration system) is laid over the sand bedding layer and up the sides of the excavation. The impermeable geomembrane is inspected for damage and all welds are tested as required. Joints between adjacent sheets of impermeable membrane should be sealed correctly using proprietary techniques with a minimum lap of 50 mm. Jointing with tape is not recommended as the system then becomes reliant on the mechanical properties of the tape to maintain its integrity.

13.5 The AquaCell Core units are installed in accordance with the installation schedule for correct orientation. Wherever possible, continuous vertical joints should be avoided. The units are arranged so that pre-formed sockets are in the correct alignment for inlet and outlet pipes. For single-layer applications, Wavin clips are used and, for multi-layers, Wavin clips and shear connectors are used.

13.6 The geotextile or impermeable geomembrane encapsulation to base, sides and top of installation, including protective geotextile (if required to protect the geomembrane) is completed. Impermeable geomembranes should be welded with double seams. All welds should be tested as required and the membrane inspected for damage.

13.7 Drainage connections are made to the installation using proprietary adaptors. Pre-formed socket positions for pipe connections must be located at the correct position for receiving pipework. Alternatively, flange adaptors are used attached to AquaCell Core units with adhesive tape and self-tapping screws (flange adaptors cannot be used at the invert of AquaCell Core units into the pre-formed socket). It is recommended that all connections and air vent installations, in attenuation/storage applications, are made with a flange adaptor, using adhesive or double-sided tape to form a seal. Alternatively, drainage connections are sealed into a pre-formed socket using proprietary seals approved by the geomembrane manufacturer.

13.8 The installation is backfilled with Type 1 or 2 sub-base or Class 6P (side fill only) selected granular material in accordance with the *Manual of Contract Documents for Highway Works (MCHW)*, Volume 1. The backfill is compacted in 150 mm thick layers.

13.9 A coarse sand protection layer, 100 mm thick, should be placed over the top of the units that have been wrapped. Backfilling is continued with:

- trafficked areas (eg car parks) — Type 1 or 2 sub-base material compacted in 150 mm layers in accordance with the MCHW, Volume 1. Compaction plant over the top of the system must not exceed 2300 kg per metre width
- landscaped and non-trafficked areas — selected as-dug material, with size of pieces less than 75 mm, compacted to 90% maximum dry density. Compaction plant over the top of the system must not exceed 2300 kg per metre width.

13.10 Pavement construction or landscaping over the AquaCell Core system is completed.

## Technical Investigations

### 14 Tests

Tests were carried out on the system to determine:

- long- and short-term resistance to loading
- performance and durability of geosynthetics
- volumetric capacity and discharge rate.

### 15 Investigations

15.1 The manufacturing process was examined, including the method adopted for quality control, and details obtained on the quality and composition of the material used.

15.2 An assessment of the system was made in relation to material properties and design procedures.

15.3 A site visit was made to assess the practicability and ease of installation and connection.

## Bibliography

- BS EN 752 : 2008 *Drain and sewer systems outside buildings*
- ASTM D 638 : 2002 *Test Method for Tensile Properties of Plastics*
- ASTM D 751 : 2000 *Standard Test Methods for Coated Fabrics*
- ASTM D 792 : 2000 *Test Methods for Density and Specific Gravity (Relative Density) of Plastics by Displacement*
- ASTM D 1004 : 1994 *Standard Test Method for Initial Tear Resistance of Plastic Film and Sheeting*
- ASTM D 1149 : 1999 *Standard Test Method for Rubber Deterioration — Surface Ozone Cracking in a Chamber*
- ASTM D 1203 : 1994 *Standard Test Methods for Volatile Loss From Plastics Using Activated Carbon Methods*
- ASTM D 1204 : 1994 *Standard Test Methods for Linear Dimensional Changes of Nonrigid Thermoplastic Sheeting or Film at Elevated Temperatures*
- ASTM D 1603 : 2001 *Test Method for Carbon Black in Olefin Plastics*
- ASTM D 5397 : 1999 *Standard Test Method for Evaluation of Stress Crack Resistance of Polyolefin Geomembranes Using Notched Constant Tensile Load Test*
- ASTM E 96 : 2000 *Standard Test Methods for Water Vapor Transmission of Materials*
- Manual of Contract Documents for Highway Works, Volume 1 *Specification for Highway Works*, August 1998 (as amended)

## 16 Conditions

16.1 This Certificate:

- relates only to the product/system that is named and described on the front page
- is granted only to the company, firm or person named on the front page — no other company, firm or person may hold or claim any entitlement to this Certificate
- is valid only within the UK
- has to be read, considered and used as a whole document — it may be misleading and will be incomplete to be selective
- is copyright of the BBA
- is subject to English law.

16.2 Publications and documents referred to in this Certificate are those that the BBA deems to be relevant at the date of issue or re-issue of this Certificate and include any: Act of Parliament; Statutory Instrument; Directive; Regulation; British, European or International Standard; Code of Practice; manufacturers' instructions; or any other publication or document similar or related to the aforementioned.

16.3 This Certificate will remain valid for an unlimited period provided that the product/system and the manufacture and/or fabrication including all related and relevant processes thereof:

- are maintained at or above the levels which have been assessed and found to be satisfactory by the BBA
- continue to be checked as and when deemed appropriate by the BBA under arrangements that it will determine
- are reviewed by the BBA as and when it considers appropriate.

16.4 In granting this Certificate, the BBA is not responsible for:

- the presence or absence of any patent, intellectual property or similar rights subsisting in the product/system or any other product/system
- the right of the Certificate holder to manufacture, supply, install, maintain or market the product/system
- individual installations of the product/system, including the nature, design, methods and workmanship of or related to the installation
- the actual works in which the product/system is installed, used and maintained, including the nature, design, methods and workmanship of such works.

16.5 Any information relating to the manufacture, supply, installation, use and maintenance of this product/system which is contained or referred to in this Certificate is the minimum required to be met when the product/system is manufactured, supplied, installed, used and maintained. It does not purport in any way to restate the requirements of the Health & Safety at Work etc Act 1974, or of any other statutory, common law or other duty which may exist at the date of this Certificate; nor is conformity with such information to be taken as satisfying the requirements of the 1974 Act or of any statutory, common law or other duty of care. In granting this Certificate, the BBA does not accept responsibility to any person or body for any loss or damage, including personal injury, arising as a direct or indirect result of the manufacture, supply, installation, use and maintenance of this product/system.





