

Waste water drainage
PRODUCT GUIDE



Wavin ED TECH PP Soil, Waste and Vent system



Contents

1. Introduction

1.1	Introduction	page	3
1.2	Fields of application	page	3
1.3	Polypropylene	page	3
1.4	Characteristics	page	4
1.5	Structure Wavin ED TECH pipes	page	4
1.6	Achievements	page	5
1.7	Properties	page	6
	1.7.1 Marking	page	6
	1.7.2 Colour	page	6
	1.7.3 Physical properties	page	6

2. Installation

2.1	Connections	page	7
2.2	Gaskets	page	7
2.3	Preparation and installation	page	7
2.4	Cutting and chamfering	page	8
2.5	Assembly of vertical columns (Drainage columns)	page	8
2.6	Assembly of horizontal pipelines	page	9
2.7	Example of columns and horizontal pipelines	page	9
2.8	Installation in concrete	page	9
2.9	Connection of Wavin ED TECH to PVC	page	10
2.10	Connection of Wavin ED TECH to cast-iron	page	10
2.11	Connection of Wavin ED TECH to lead	page	10
2.12	Fittings HTMM – HTU – HTLL	page	10
2.13	Some examples of utilisation	page	11
2.14	Example list of materials for a bathroom	page	11

3. Product List

page 12

1. Introduction

1.1 Introduction

Wavin ED TECH is a complete soil, waste and vent system made of polypropylene. It has established itself in the European market for in-house and industrial discharge systems, due to its excellent chemical and physical properties in the material used and by its ease of connection and assembly. The revolutionary technology used for the ED TECH pipes is a result of years of research in the most skilled laboratories in the United States of America (Trexel Inc.) and Europe (Wavin T&I).

Its technology is based on studies developed together with the M.I.T. in Boston (Massachusetts Institute of Technology). The Wavin ED TECH system consists of pipes and fittings. The pipes are available in a range of 32, 40, 50, 75, 90, 110, 125 and 160mm in a large variety of lengths and configurations: double socket, single socket and plain ended. The system also consists of a broad range of rubber-ring fittings (elbows), branches, access fittings, connectors, reducers, WC-fittings and many more products.

The Wavin ED TECH system meets all requirements, in accordance with EN 1451 and ISO standards.

1.2. Fields of application

The standards for WAVIN ED TECH provide for the following conditions and fields of application:

CONDITIONS OF USE

Maximum temperature of fluids to be conveyed: 95°C

FIELDS OF APPLICATION

The Wavin ED TECH systems is used for in-house drainage applications, e.g.:

- a. sanitary facilities;
- b. washing machines and dish washers;
- c. large kitchens, laundries, industrial plants in case of extended use of waste water;
- d. Schools, laboratories and industrial buildings in case of use of aggressive fluids.

WAVIN ED TECH is also suitable for drainage of rainwater inside buildings.

1.3 Polypropylene

The whole range of ED TECH products is manufactured from flame retardant polypropylene (PP), a raw material with excellent physical and chemical properties. Polypropylene is a thermoplastic resin meaning that its state according to temperature is reversible, thus getting plastic with heat and returning rigid with cold.

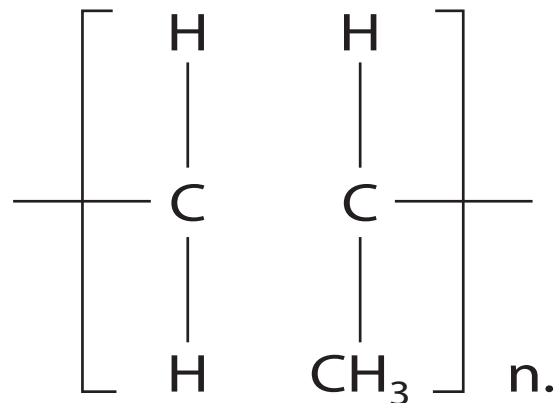

Polypropylene presents a monomeric unit.

In practice, only isotactic polypropylene is used (all CH₃ groups are orientated i.e. they are all positioned on the same side of the chain), and it is obtained from polymerisation of polypropylene by means of stereo specific catalysts. Polypropylene has a lower density than polyethylene. It has the lowest of all thermoplastic materials, but shows high mechanical resistance, a high melting point (175 °C) and an excellent stability in size. Polypropylene is a colourless, translucent and rigid thermoplastic product with good mechanical properties, extremely good dielectric and electrically insulating characteristics and high resistance to chemical agents. Polypropylene is a very versatile material and is used in the manufacture of textile fibres, big capacity tanks for solid and liquid material (TANKONE), valves and fittings of even bigger dimensions, exhaust fans getting into contact with corrosive gases and a variety of parts in the textile, automotive, electric, and electronic industry. ED TECH pipes and fittings are made of a special flame retardant formula, obtained by adding special substances to polypropylene, thus conforming it to the fire regulations in force in almost all European and several non-European countries. ED TECH pipes and fittings are used in a wide variety of European countries for house drainage. This product has been qualified by the most important European institutes of quality marking.

1.4 Characteristics

Wavin ED TECH is a system of self-extinguishing polypropylene pipes and fittings that, thanks to the specification of the raw material used and because of the technological detail in its manufacture, is characterized by:

- ⤵ High molecular weight of the raw material used;
- ⤵ Excellent resistance to acidic and caustic (alkaline) materials including all commonly used detergents and dry cleaning chemicals;
- ⤵ High impact resistance;
- ⤵ Excellent resistance to waste water from washing machines and dishwashers;
- ⤵ The wide range of pipe diameters (from 32 mm to 160 mm), of fittings, and of special accessories;
- ⤵ Easy connection;
- ⤵ Elastomeric rubber seals that have as long a working life as the pipes;
- ⤵ Smooth surfaces (favouring the flow of waste water) and avoiding the formation of incrustations;
- ⤵ Low thermal conductivity limiting condensation;
- ⤵ Good packaging system facilitating transport and storage of the tubes and couplings as well as avoiding ovalization and flattening.

1.5 Structure Wavin ED TECH pipes

The pipe is made up of 3 polypropylene layers and has an increased thickness (for example, the 110 mm ED TECH pipes offer a 26% higher wall thickness compared to traditional polypropylene pipes).

The pipes are manufactured by coextrusion, which means that the 3 layers are permanently linked. Each layer has its specific functions to realise a superior performance as a whole.

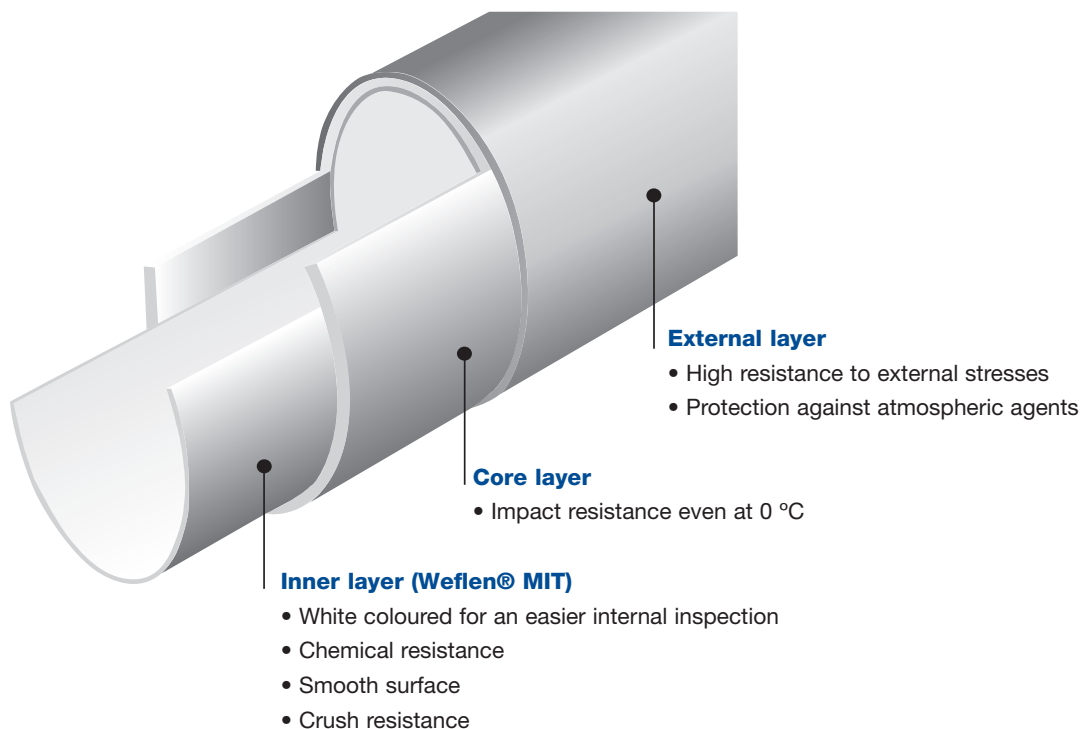

1.6 Achievements

The 3-layer pipe with increased wall thickness not only make the pipe extremely robust to ambient temperature but also to frosts (0°C) when the probability of breakage is significantly greater. It should be remembered that traditional pipes only have good impact resistance (in agreement with EN 1451 and EN 744) at a temperature of 23°C (see table 1). ED TECH pipes are only damaged by more force than is normally met during construction on a building site.

What is more, the pipe is not only highly robust but also flexible giving it considerable resistance to flattening so it more than meets a variety of installation requirements. Another important factor is the white internal layer made of Weflen MIT, a material conceived in the Wavin laboratory that helps the flow of waste

water discharged, limiting incrustations and adherence of detergents and organic products to the minimum not to mention the formation of mold. Lastly, the special white coloration facilitates easier internal inspection. Numerous patents for this technology protect Wavin's exclusivity.

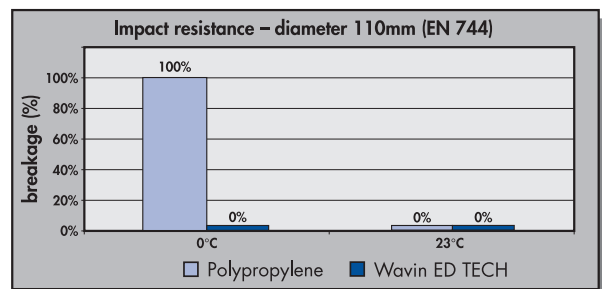

Resistance to discharge water

The wall thickness and the raw material used guarantee a high resistance to hot water from washing machines and dish washers.

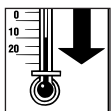

Resistance to low temperature

The elasticity of Wavin ED TECH makes the system resistant, even in case of frost.

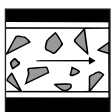

Resistance to abrasion

Drainage water may contain suspended particles, which may cause abrasion. Wavin ED TECH resists to these particles due to the compactness and smoothness of the walls. The wall thickness assures a considerable security also in the most critical conditions.



Absence of clogging

The walls of pipes and fittings are perfectly smooth, ensuring the discharge of all kinds of drainage water. Good installation is key to avoiding such problems.



The gaskets of Wavin ED TECH

When drainage takes place, the Wavin ED TECH gaskets of the sockets are getting wet only marginally. Despite this they are resistant to all kinds of chemical agents in the same way as polypropylene is. Gaskets are made of an elastomeric material that assures a perfect sealing and durability (even under hard working conditions)



Flexibility

Flexibility is a must, especially for buildings exposed to strong vibrations (earthquakes). The sockets have the same function as expansion joints, thanks to the rubber-ring push fit system.



Easy connection by means of sockets

Wavin ED TECH pipes and fittings can be easily connected by means of the push fit system. It is the most simple and fast connecting system.



Impact resistance

At room temperature Wavin ED TECH shows a very good resistance to impact. This resistance is maintained even at low temperatures.



Rubber ring connection

The pipes and fittings can be connected by means of rubber rings, no glue necessary.

1.7 Properties

1.7.1 Marking

Each pipe or fitting is marked as follows:

- Commercial brand (Wavin ED TECH)
- Applicable quality standards (EN 1451, DIN 4102-B2)
- Quality mark (IIP 152, UNI)
- Indications of outside diameter and wall thickness
- Indications of outside diameter (DN) and thickness series "S" (fittings only)
- Angle (fittings only)
- Year, month, day and shift of production (pipes only)
- Year of production (fittings only)

The quality marks applied to our pipes and fittings give our customers the guarantee that there is a continuous control of:

- Raw material
- Tightness of gasket
- Dimensions
- Flame retardation
- Physical properties

1.7.2 Colour

Wavin ED Tech pipes and fittings are grey-coloured and stabilised for UV exposure. The grey tone of ED TECH corresponds to RAL colour 7037, according to DIN standards.

1.7.3 Physical properties

The flame retardant polypropylene used for the production of ED TECH pipes and fittings has the following physical properties.

Raw material

Polypropylene (PP)

Density g/cm³

0.91 (pipes 32 – 50mm)
0.75 (pipes 75 – 160mm)
(ASTM D 1505)

Dia (mm)

32	1.9
40	1.9
50	1.9
75	2.3
90	2.8
110	3.4
125	3.4
160	4.3

Wall thickness (mm)

Weight per meter of pipe (plain ended HTGL)

DN (mm)

DN (mm)	kg/m
40	0.218
50	0.274
75	0.414
90	0.586
110	0.854
125	0.976

Jointing method

Rubber-ring push fit

Hot water resistance

95° C short term loading
90° C long term loading

Chemical resistance

pH 2 - 12

Linear expansion

0.12 mm x m C

Quality marking

IIP 152, UNI

2. Installation

2.1 Connections

The main characteristic of the Wavin ED TECH system is that all pipes and fittings have a socket with an elastomeric gasket. This simple system of connection, carried out by hand, enables a quick connection of different pipes and fittings. No glue or tools are required. ED TECH fittings are all injection moulded and correspond to EN 1451 standards.

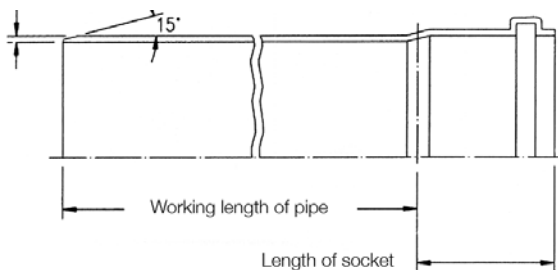

Nominal diameter	Wall thickness	Internal diameter socket	Wall thickness socket	Length of socket
mm	mm	mm	mm	mm
32	1,9	32,3	1,6	46
40	1,9	40,3	1,6	48
50	1,9	50,3	1,6	50
75	2,3	75,4	1,7	55
90	2,8	90,4	2,0	65
110	3,4	110,4	2,4	70
125	3,4	125,4	2,8	75
160	4,3	160,4	3,6	83

2.2 Gaskets

The gaskets inside the sockets are of elastomeric material, thus giving a guaranteed tightness and durability, even under extreme conditions. Furthermore, they have the same properties and resistance to chemical agents and high temperatures as polypropylene. Their special shape of "lips" assures a simple and secure connection. All gaskets used for the ED TECH system have the German quality mark PA-I. If stored, pipes and fittings come into contact with sand, dust or crushed stone. The gasket can be taken out in order to be cleaned and put back into its seat, to ensure the best working conditions. The particular shape of the gasket makes it possible to support offsets of pipes up to 4° without losing their perfect tightness.

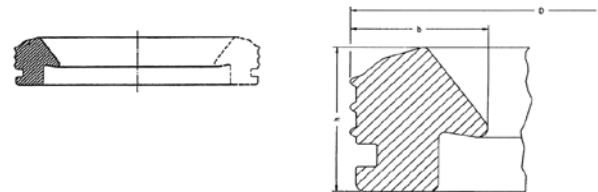

2.3 Preparation and installation

Every material will either expand or contract when exposed to temperature differences. The coefficient of expansion of ED amounts to 0.12 mm·m·C. Independent of the type of drainage used, recommendations in order to compensate for expansion of the ED TECH system can be synthesized as follows:

The part to be connected must be inserted into the socket, until it reaches the bottom of the socket and then has to be extracted by 1 cm (see figure below).

Insert the pipe into the socket until the end of the pipe, mark the pipe with a pencil at the beginning of the socket and extract the pipe for 1cm in relation to the marked line. This simple working process ensures that the pipe will absorb thermal expansion; the depth of the socket was calculated to absorb expansion or contraction of pipes with a maximum length of 3 cm. The result of an insufficient depth of connection will be a weak junction. The results of excessive depth of the connection (to insert the pipe until the end of the socket) could prevent the expansion of the pipeline. The Wavin ED TECH system can be used for all drainage systems in buildings, from houses to shopping centres. It can also be used for industrial plants and laboratories. Additionally it can be used as a down pipe for gutter systems (rainwater).

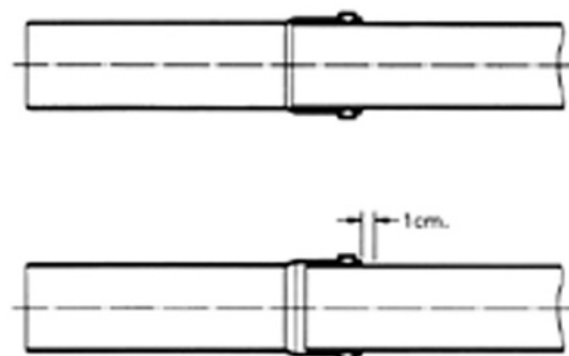

2.4 Cutting and chamfering

Wavin ED TECH pipes can be cut using a pipe cutter or a fine toothed saw. Square cuts can be achieved by means of a guided saw. In case of large pipe diameters a cutting disk can be utilized. The cut edges must be deburred. The pipe ends are to be chamfered and cleaned, thus forming an angle of about 15° (it is advisable to use a bevelling machine for diameters from 40 up to and including 315 mm). This will ensure that the gasket of the socket will not be damaged when the pipe is inserted. Any dust, sand, or traces of concrete or lubricant in the section inserted in the socket are cleaned using an appropriate lubricant in a tube or by using a lubricant spray. Use of mineral oils and fats is absolutely excluded. After insertion, the spigot is pulled back a centimeter.

WAVIN ED TECH does not need a specific device when it is in contact with products composed of other materials. All the same, it is a good idea to protect it with adhesive tape or thick paper in the connecting section between spigot and socket to prevent possible infiltration of cement particles.

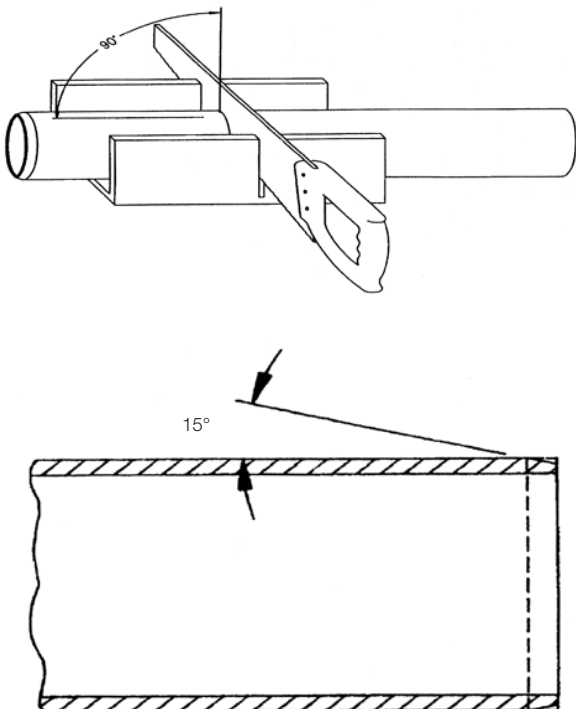

2.5 Assembly of vertical columns (Drainage columns)

The existence of expansion sockets simplifies the assembly of drainage columns. To prevent the column from sliding downwards, a guide bracket has to be fixed under the pipe socket, immediately after the column installation. Vertical pipes can be assembled in two different ways:

- 1) Column with branch on the floor, buried in concrete;
- 2) Column with branch on the floor, free.

In the first case, the branch on the floor, buried in concrete gives origin to a natural “fixed point”, provided that the branch and the column have the same diameter, so that no further fixed points are needed.

Should any column dilatation take place, it will be absorbed by the expansion socket of the underlying branch. A movable bracket situated between the two floors will work as a pipe guide.

In the second case, where the branch is not fixed in concrete, the creation of a fixed point is necessary. This “fixed point” is made by fixing the pipe socket with a bracket, which, in turn, is fixed to the wall. A movable bracket situated between the two floors will work as a pipe guide. Distance between the brackets: 15 x diameter (Ø mm).

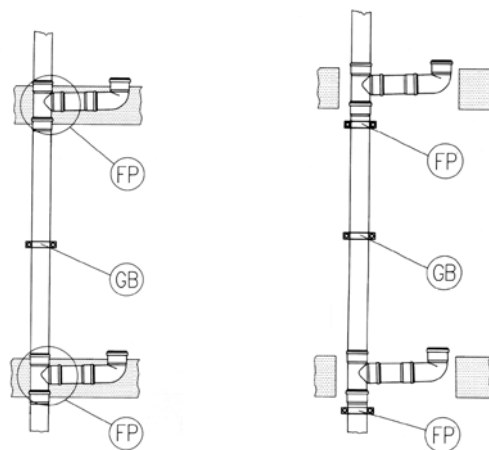

Column buried in concrete

Free column

FP = Fixed Point

GB = Guide Bracket

2.6 Assembly of horizontal pipelines

As in the case of columns, also horizontal pipelines for drainage do not require specific interventions during their assembly and installation, thanks to the expansion sockets and the pipes' reduced length (maximum length: 3 metres).

The sockets have to be fixed to the structure (ceiling or wall) by means of brackets in order to create a "fixed point". The pipes are supported by guide brackets placed at a distance of 10 times the pipe diameter. A fixed point has also to be made in correspondence with every branch and branch of the pipeline.

It is, however, advisable to reduce the distance between the structure and the pipeline as much as possible, taking into account the slope, in order to avoid bending of the support. When installed according to these instructions, horizontal pipes will be well supported and guided and their functionality will be guaranteed.

Distance between the brackets: 10 x diameter (Ø mm).

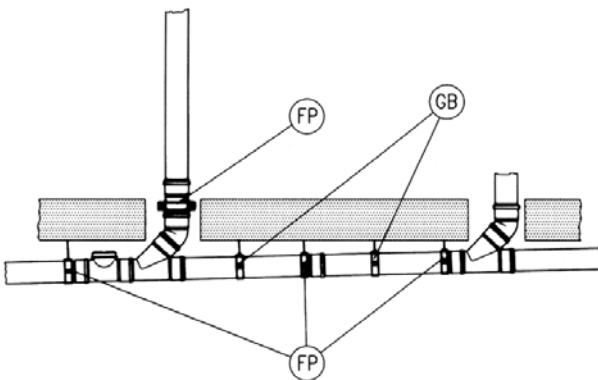

FP = Fixed Point GB = Guide Bracket

2.7 Example of columns and horizontal pipelines

The guide brackets and fixed points should be placed in such a way so as not to hinder the axial contraction and extension caused by thermal expansion.

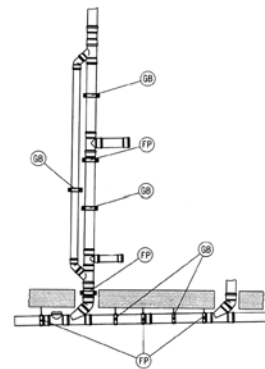

FP = Fixed Point GB = Guide Bracket

2.8 Installation in concrete

Wavin ED TECH pipes and fittings can directly be embedded in concrete casting. Even if they do not stick to the concrete casting, movement will be restricted due to the resistance given by the shape of the sockets of pipes and fittings. Owing to its high elasticity, PP material is able to absorb dilatation. Pipes conveying continuously high temperature waste waters (in case of dishwashers, washing-machines, laboratories) should be protected by heavy or corrugated paper, put around the sockets in order to improve dilatation caused by the differences in temperature. During concrete casting, pipes may be compressed. For this reason it is advisable to fill the pipes with water, thus limiting pressure. One can also carry out concrete casting only partially i.e. in steps or stages, so that concrete does not set all at once.

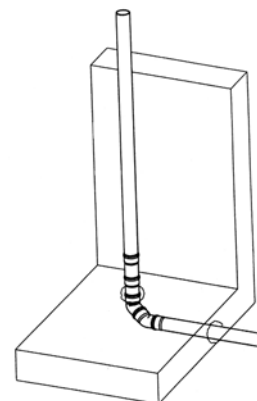

2.9 Connection of Wavin ED TECH to PVC

Wavin has manufactured special PVC transition fittings, which the installer can use to connect the WAVIN ED TECH to PVC columns or bends. This frequently occurs in renovation projects.

The transition fitting is manufactured from PVC and is connected to the spigot end of a PVC pipe or fitting by means of glue. The socket end is designed exactly to accept a ED spigot end. If the vertical downpipe is made of PVC, it is possible to connect ED TECH, using the elbow fittings shown below. The fitting will be connected to the downpipe by means of glue.

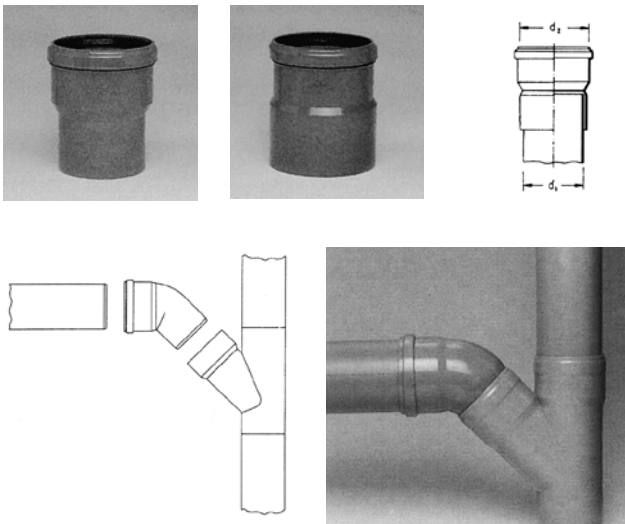

The following sizes are available:

d/d1	α
110/100	15°
110/100	30°
110/100	45°
110/100	67°30'
110/100	87°30'

2.10 Connection of Wavin ED TECH to Cast-iron

The connection between ED and cast-iron pipes can be carried out by means of a HTUG fitting. The double ring gasket has to be put on the spigot end of the cast-iron pipe and then the HTUG fitting is put on. It is advisable to fill the air space with inert material.

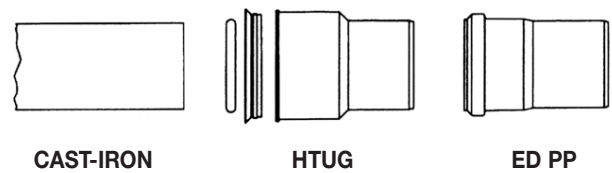

2.11 Connection of Wavin ED TECH to lead

In order to connect ED to lead pipes, a brass adaptor is used.

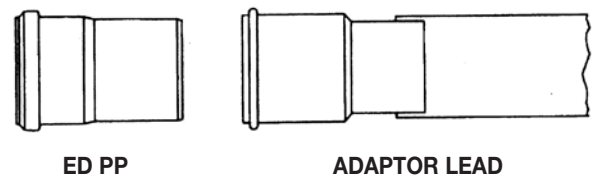

2.12 Fittings HTMM – HTU – HTLL

With these special fittings, reparations on the working place or even variations on an already existing pipeline are possible. It is also possible to use pieces of pipes.

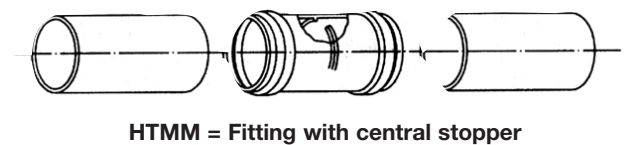

HTMM = Fitting with central stopper

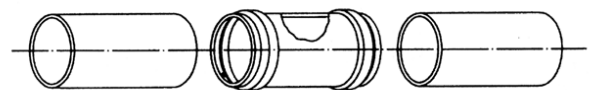

HTU = Fitting without stopper

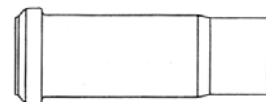

HTLL = Double length connector

2.13 Some examples of utilisation

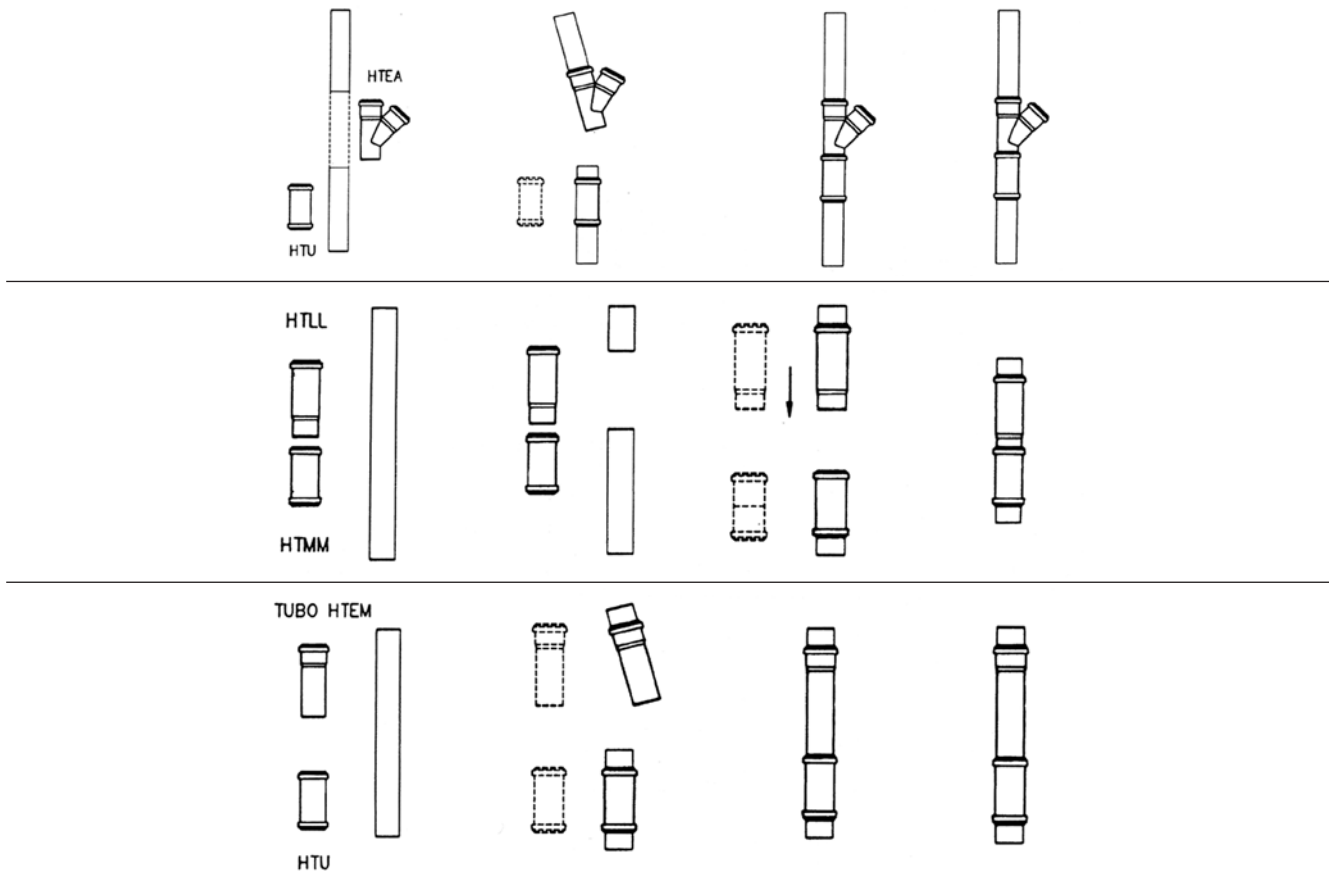

2.14 Example list of materials for a bathroom

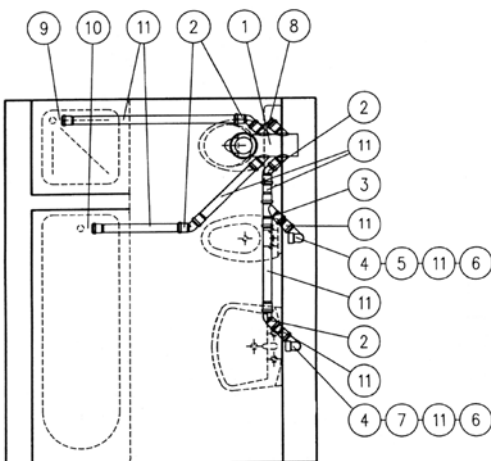

Item	Description	Diameter	Number
1	WC bend with 4 connectors	Ø 40	1
2	Bend 45°	Ø 40	4
3	Branch 45°		1
4	Gasket		2
5	Double length bend for connection with trap	Ø 40x1¼"	1
6	Bend 87° 30	Ø 40	2
7	Bend for connection with trap HTSW	Ø 40 x 1¼"	1
8	Protection cap	Ø 40	1
9	Shower trap	Ø 80 x 40	1
10	Pipeline for bath - tub	Ø 40	1
11	Pipe	Ø 40	

3. Product list

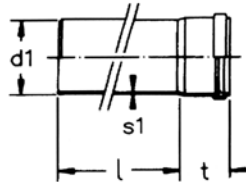

(d1) Nominal diameter	(de) Socket depth	(S1) Wall thickness	(t) Length of socket
32	41	1,9	46
40	53,2	1,9	48
50	63,2	1,9	50
75	88,3	2,3	55
90	105,5	2,8	65
110	126	3,4	70
125	145	3,4	75
160	184	4,3	83

Pipe socket / spigot HTEM

Article Code	d1	L (mm)
55 0102	32	250
55 0103	32	500
55 0105	32	1.000
55 0107	32	1.500
55 0109	32	2.000
55 0111	32	3.000
55 0122	40	250
55 0123	40	500
55 0124	40	750
55 0125	40	1.000
55 0127	40	1.500
55 0129	40	2.000
55 0131	40	3.000
55 0142	50	250
55 0143	50	500
55 0144	50	750
55 0145	50	1.000
55 0147	50	1.500
55 0149	50	2.000
55 0151	50	3.000
55 0202	75	250
55 0203	75	500
55 0204	75	750
55 0205	75	1.000
55 0207	75	1.500
55 0209	75	2.000
55 0211	75	3.000
55 0222	90	250
55 0223	90	500
55 0224	90	750
55 0225	90	1.000
55 0227	90	1.500
55 0229	90	2.000
55 0231	90	3.000
55 0242	110	250
55 0243	110	500
55 0244	110	750
55 0245	110	1.000
55 0247	110	1.500
55 0249	110	2.000
55 0251	110	3.000
55 0262	125	250
55 0263	125	500
55 0265	125	1.000
55 0267	125	1.500
55 0269	125	2.000
55 0271	125	3.000
55 0282	160	250
55 0283	160	500
55 0285	160	1.000
55 0287	160	1.500
55 0289	160	2.000
55 0291	160	3.000

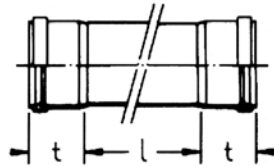

Pipe socket / socket HTDM

Article Code	d1	L (mm)
55 0303	32	500
55 0305	32	1.000
55 0309	32	2.000
55 0311	32	3.000
55 0323	40	500
55 0325	40	1.000
55 0327	40	1.500
55 0329	40	2.000
55 0331	40	3.000
55 0343	50	500
55 0345	50	1.000
55 0347	50	1.500
55 0349	50	2.000
55 0351	50	3.000
55 0403	75	500
55 0405	75	1.000
55 0407	75	1.500
55 0409	75	2.000
55 0411	75	3.000
55 0423	90	500
55 0425	90	1.000
55 0427	90	1.500
55 0429	90	2.000
55 0431	90	3.000
55 0443	110	500
55 0445	110	1.000
55 0447	110	1.500
55 0449	110	2.000
55 0451	110	3.000
55 5463	125	500
55 5465	125	1.000
55 5467	125	1.500
55 5469	125	2.000
55 5471	125	3.000

Fittings

The Wavin ED TECH fittings are injection moulded. The length and insert depth of each fitting is according to the EN 1451 standard.

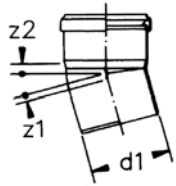

Elbow socket / spigot 15° HTB

Article Code	d1	z1	z2
24 1221D	32	4	8
24 1231D	40	5	8
24 1251D	50	5	9
24 1281D	75	7	11
24 1294D	90	7	12
24 1301D	110	9	14
24 1311D	125	10	15
24 1321D	160	13	19

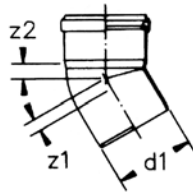

Elbow socket / spigot 30° HTB

Article Code	d1	z1	z2
24 1223D	32	6	10
24 1233D	40	7	11
24 1253D	50	9	12
24 1283D	75	12	15
24 1298D	90	14	17
24 1303D	110	17	21
24 1313D	125	19	23
24 1323D	160	24	30

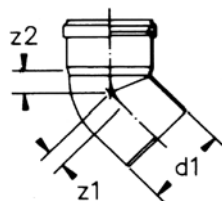

Elbow socket / spigot 45° HTB

Article Code	d1	z1	z2
24 1224D	32	9	12
24 1234D	40	10	14
24 1254D	50	12	16
24 1284D	75	18	21
24 1304D	110	25	29
24 1314D	125	28	33
24 1324D	160	36	42

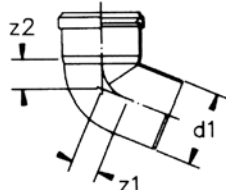

Elbow socket / spigot 67.5° HTB

Article Code	d1	z1	z2
24 1226D	32	14	17
24 1236D	40	16	20
24 1256D	50	20	23
24 1286D	75	28	31
24 1306D	110	40	44
24 1316D	125	46	50

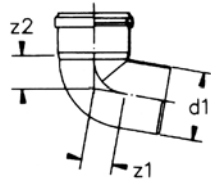

Elbow socket / spigot 80° HTB

Article Code	d1	z1	z2
24 1237D	40	20	24
24 1257D	50	24	28
24 1287D	75	35	38
24 1307D	110	50	54

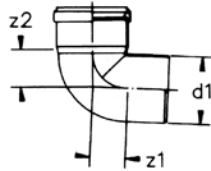

Elbow socket / spigot 87.5° HTB

Article Code	d1	z1	z2
24 1228D	32	19	23
24 1238D	40	23	26
24 1258D	50	28	31
24 1288D	75	40	43
24 1308D	110	57	61
24 1318D	125	65	70
24 1328D	160	83	89

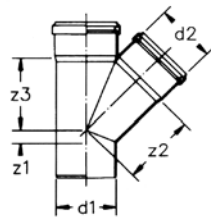

Branch 45° HTEA

Article Code	d1	z1	z2	z3
24 2005D	32/32	9	39	39
24 2008D	40/32	5	45	43
24 2009D	40/40	10	49	49
24 2016D	50/40	5	56	54
24 2018D	50/50	12	61	61
24 2030D	75/40	-7	74	67
24 2031D	75/50	-1	79	74
24 2034D	75/75	18	91	91
24 2035D	90/40	15	85	60
24 2036D	90/50	-6	121	121
24 2038D	90/75	10	108	114
24 2040D	90/90	17	117	117
24 2042D	110/40	-24	99	84
24 2043D	110/50	-17	104	91
24 2046D	110/75	1	116	109
24 2048D	110/110	25	134	134
24 2055D	125/110	18	144	141
24 2056D	125/125	28	152	152
24 2071D	160/110	1	168	159
24 2072D	160/125	12	176	169
24 2074D	160/160	36	194	194

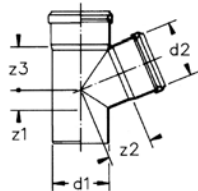

Branch 67.5° HTEA

Article Code	d1/d2	z1	z2	z3
24 2109D	40/40	16	33	33
24 2116D	50/40	14	39	35
24 2118D	50/50	20	41	41
24 2134D	75/75	28	59	59
24 2142D	110/40	3	71	48
24 2143D	110/50	8	73	54
24 2148D	110/110	40	86	86
24 2155D	125/110	38	93	89
24 2156D	125/125	46	97	97
24 2171D	160/110	31	112	96

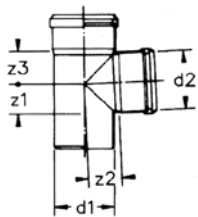

Branch 87.5° HTEA

Article Code	d1/d2	z1	z2	z3
24 2205D	32/32	19	21	21
24 2209D	40/40	23	25	25
24 2216D	50/40	23	30	25
24 2218D	50/50	28	30	30
24 2230D	75/40	22	42	26
24 2231D	75/50	27	43	31
24 2234D	75/75	40	43	43
24 2236D	90/40	23	50,5	27
24 2237D	90/50	28	50	32
24 2240D	90/90	42	57	57
24 2242D	110/40	23	59	27
24 2243D	110/50	28	60	32
24 2246D	110/75	40	60	45
24 2248D	110/110	57	62	62
24 2255D	125/110	58	69	63
24 2256D	125/125	65	70	70
24 2271D	160/110	58	86	64
24 2272D	160/125	66	87	71
24 2274D	160/160	83	89	89

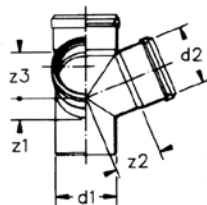

Double corner Y branch 67.5° HTED

Article Code	d1/d2	z1	z2	z3
24 2522D	110/110	40	86	86

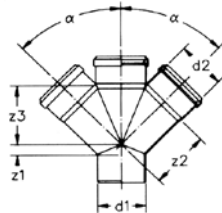

Double Y branch HTDA

Article Code	d1/d2	α	z1	z2	z3
24 2618D	50/50	67.5°	20	41	41
24 2634D	75/75	67.5°	28	59	59
24 2544D	90/40	45°	15	85	85
24 2545D	90/50	45°	7	90,5	90,5
24 9990D	110/40	45°	-24	99	84
24 2643D	110/50	67.5°	8	73	54
24 2646D	110/75	67.5°	22	78	67
24 2648D	110/110	67.5°	40	86	86

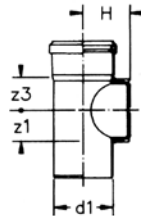

Access pipe with screwed cover HTRE

Article Code	d1/d2	z1	z3	H
24 0865D	50/ 50	28	30	48
24 0868D	75/ 75	40	43	84
24 0869D	90/90	60	60	90
24 0870D	110/110	57	62	88
24 0871D	125/110	65	70	110
24 0873D	160/110	83	89	110

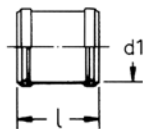

Repair sockets HTU

Article Code	d1	L
24 4032D	32	95
24 4033D	40	107
24 4035D	50	110
24 4038D	75	114
24 4039D	90	119
24 4040D	110	130
24 4041D	125	177
24 4043D	160	196

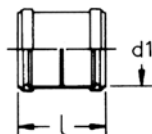

Double socketed connector HTMM

Article Code	d1	l
24 4802D	32	95
24 4803D	40	107
24 4805D	50	110
24 4808D	75	114
24 4809D	90	120
24 4810D	110	130
24 4811D	125	177
24 4812D	160	196

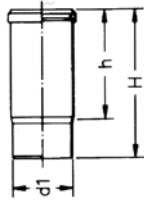

Double length connector HTLL

Article Code	d1	h	H
24 4103D	40	175	160
24 4105D	50	175	160
24 4108D	75	190	260
24 4109D	90	170	235
24 4110D	110	190	260

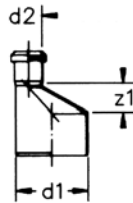

Eccentric reducer type "A" HTR

Article Code	d2/d1	z1
24 0718D	32/40	12
24 0719D	32/50	15
24 0616D	40/50	12
24 0630D	40/75	26
24 0631D	50/75	20
24 0643D	50/110	40
24 0646D	75/110	26
24 0647D	90/100	18
24 0655D	110/125	15
24 0671D	110/160	34
24 0672D	125/160	27
24 0636D	50/90	
24 0722D	75/90	



Eccentric reducer type "B" HTR

Article Code	d2/d1
24 0600D	40/75
24 0635D	40/90
24 0603D	50/75
24 0636D	50/90
24 0601D	50/110
24 0602D	75/110

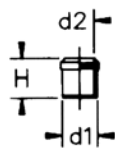

Concentric reducer

Article Code	d2/d1	H
24 0708D	32/40	65
24 0716D	40/50	55
24 0722D	75/90	75
24 0750D	90/75	
24 0724D	90/110	
24 0751D	110/90	
24 0725D	110/125	
24 0752D	125/110	

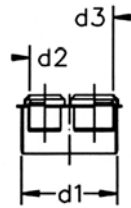

Double reducer

Article Code	d3/d2/d1
24 0744D	40/40/110
24 0745D	50/40/125

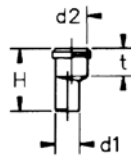

Eccentric reducer

Article Code	d2/d1	t	H
24 0721D	40/32	50	95
24 0720D	50/40	45	105

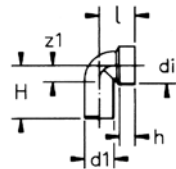

Elbow (without rubber gasket) HTSW

Article Code	d1	di	z1	L	h	H
24 3900D	32	46	19	50	26	70
24 3901D	40	46	24	56	26	79
24 3902D	50	46	29	61	26	80
24 3903D	40	53	24	57	26	81
24 3904D	50	53	29	62	26	82
24 3905D	50	67	29	61	26	90

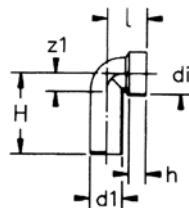

Double length elbow (without rubber gasket) HTSWL

Article Code	d1	di	z1	L	h	H
24 3907D	40	46	24	56	26	125

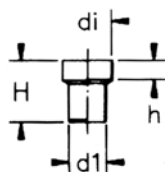

Siphon / Trap connector (without rubber gasket) HTS

Article Code	d1	di	h	H
24 3910D	32	46	26	78
24 3911D	40	46	26	80
24 3912D	50	46	26	83
24 3913D	40	53	26	83
24 3914D	50	53	26	83

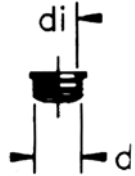

Rubber connector for siphon / trap

Article Code	Tipo	d	di
30 8040	(A)	46	1"
30 8041	(B)	46	1 1/4"
30 8042	(C)	46	1" - 1 1/4"
30 8044	(D)	46	1 1/2"
30 8046	(E)	53	1" - 1 1/4"
30 8048	(F)	53	1 1/2"
800004	(G)	67	2"

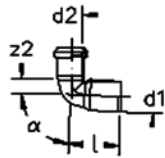

Reduced elbow 87° 30' spigot / socket HTRB

Article Code	a	d1/d2	z2	L
24 1716D	87°30'	50/40	26	85

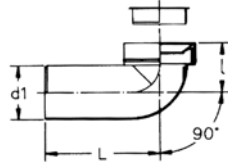

WC connector HTSB

Article Code	d1	l	L
24 3082D	110	100	230

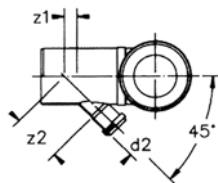

WC elbow with rotary connection HTSB

Article Code	d1/d2	l	z1	z2
24 3108D	110/40	100	- 24	95
24 3109D	110/50	100	- 17	105

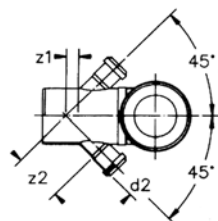

WC elbow with 2 connections HTSB

Article Code	d1/d2	l	z1	z2
24 3106D	110/50	100	- 17	105

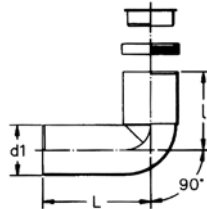

WC elbow extended HTSBL

Article Code	d1	l	L
24 3086D (corta)	90	170	106
24 3087D	110	185	230

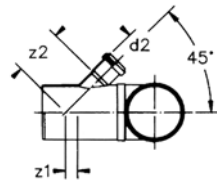

WC elbow extended with rotary connector HTSBL

Article Code	d1/d2	l	z1	z2
24 3113D	90/40	172		85
24 3114D	90/50	172		90,5
24 3118D	110/40	185	- 24	95
24 3119D	110/50	185	- 17	105

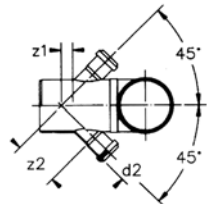

WC elbow extended with 2 connectors HTSBL

Article Code	d1/d2	l	z1	z2
24 3111D	90/40	172		85
24 3112D	90/50	172		90,5
24 3115D	110/40	185	- 24	95
24 3116D	110/50	185	- 17	105

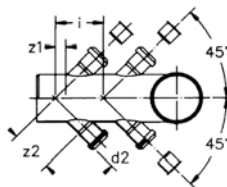
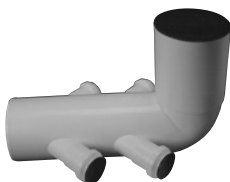

WC elbow extended with 4 connectors HTSBL

Article Code	d1/d2	i	z2	z1	L
24 3107D	110/40	185	95	- 24	315

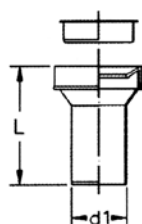

WC adaptor (with seal) HTSK

Article Code	d1	L
24 3034D	90	180
24 3032D	110	350

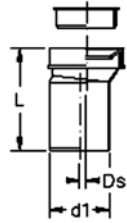

Eccentric coupler (white) HTSK

Article Code	d1	L	Ds
24 3036D	110	180	12,5

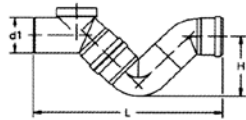

Siphon / Trap "Firenze"

Article Code	d1	H	L
24 0948D	110	175	540
24 0956D	125	220	600

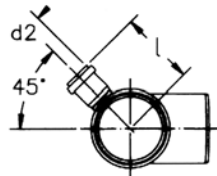

Elbow with left connector HTB

Article Code	d1/d2	l	α
24 3155D	110/40	120	87.5°
24 3160D	110/50	120	87.5°

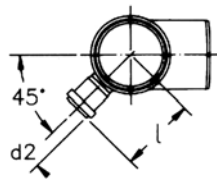

Elbow with right connector HTB

Article Code	d1/d2	l	α
24 3165D	110/40	120	87.5°
24 3170D	110/50	120	87.5°

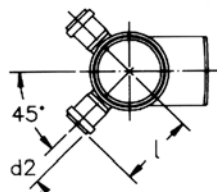

Elbow with 2 connectors HTB

Article Code	d1/d2	l	α
24 3175D	110/40	120	87.5°
24 3180D	110/50	120	87.5°

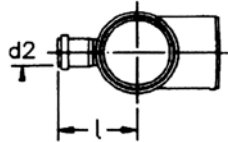

Elbow with frontal connector HTB

Article Code	d1/d2	l	α
24 3181D	110/40	120	87.5°
24 3182D	110/50	120	87.5°

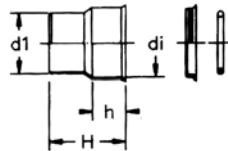

Transition fitting Wavin AS HTUG

Article Code	d1	h	di
24 5935D	50	45	80
24 5938D	75	80	92
24 5940D	110	75	124
24 5941D	125	85	149



Protection cap for pipe end HTM

Article Code	d1
24 4543D	40
24 4546D	50
24 4551D	75
24 4552D	90
24 4553D	110
24 4554D	125
24 4555D	160

Female transition fitting PVC / PE – PP

Article Code	Dimensions
300019	100/110
300020	110/100

Transition fitting PVC / PE – PP

Article Code	Dimensions
300004	40/40
300005	50/50
300006	63/63
300015	75/80
300007	75/82
300010	110/100
300011	110/125
300012	125/125
300022	125/110

**Connecting elbow PP – PVC – socket /
spigot 110/100mm**

Article Code	α
301002	15°
301003	30°
301004	45°
301005	67°30'
301006	87°30'

Loose sealing rings

Article Code	d1
800013	32
800014	40
800015	50
800016	75
800017	110
800018	125

Connector from PP to metal

Article Code	d1
800020	40 / 1" – 1 ¼ "

Lubricant for pipes and fittings

Article Code	g
400010	250
400012	500

Lubricant for pipes and fittings (spray)

Article Code	ml
400020	400

Plastic support for pipes

Article Code	d1
329090	32/40/50
329091	75/110

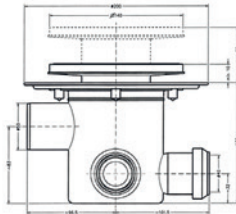

PP 4-way with sockets with grill and trap

- ⊕ Grey polypropylene
- ⊕ Adjustable check valve ΔH 53 mm
- ⊕ 3 DN 40 inlets and 1 DN 50 outlet inlets require opening
- ⊕ Embedding tongue seals

Article Code

M614

Spares

M6121 140 x 140 mm grill

M6122 Grill holder

M6125 Open seal

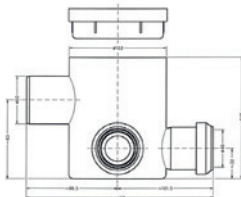

PP 4-way with sockets

- ⊕ Grey polypropylene
- ⊕ 3 DN 40 inlets and 1 DN 50 outlet inlets require opening
- ⊕ Embedding tongue seals

Article Code

M643

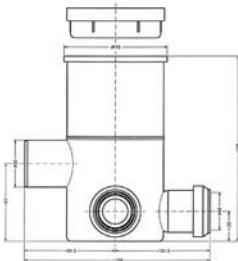

High PP 4-way with sockets

- ⊕ Grey polypropylene
- ⊕ 3 DN 40 inlets and 1 DN 50 outlet inlets require opening
- ⊕ Embedding tongue seals

Article Code

M643

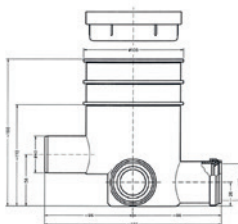

Universal PP 4-way with DN 40 outlet sockets

- ⊕ Grey polypropylene
- ⊕ 3 DN 40 inlets and 1 DN 40 outlet inlets require opening
- ⊕ Embedding tongue seals

Article Code

M682

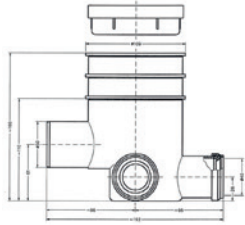

Universal PP 4-way with DN 50 outlet sockets

- › Grey polypropylene
- › 3 DN 40 inlets and 1 DN 50 outlet inlets require opening
- › Embedding tongue seals

Article Code

M699



Backflow prevention valves

- › DN 50 (HL 4) automatic
- › Can be installed horizontally or vertically

Article Code

609851



High PP 4-way with sockets

- › DN 110 (HL 710) automatic

Article Code

609852

Brackets and Fire Collars



Bracket Insert

Article code	Ø
305504	40
305505	50
305506	63
305507	75
305508	90
305509	110
305510	125
305511	160
305512	200



Galvanised PE Bracket

Article code	Ø
305014	40 x 1/2"
305015	50 x 1/2"
305016	63 x 1/2"
305017	75 x 1/2"
305018	90 x 1/2"
305019	110 x 1/2"
305020	125 x 1/2"
305021	160 x 1/2"
305025	200 x 1"
305026	250 x 1"
305027	315 x 1"



Galvanised PE Bracket M10 connection

Article code	Ø
305004	40
305005	50
305006	63
305007	75
305008	90
305009	110
305010	125
305011	160



Fire Collar EFM

Article code	Ø
309180	40x63
309182	75
309183	78x90
309184	110
309185	125
309186	135x160
309187	200
309188	250

Discover our broad portfolio at
www.wavinoverseas.com
www.wavin.ae
www.wavin.asia

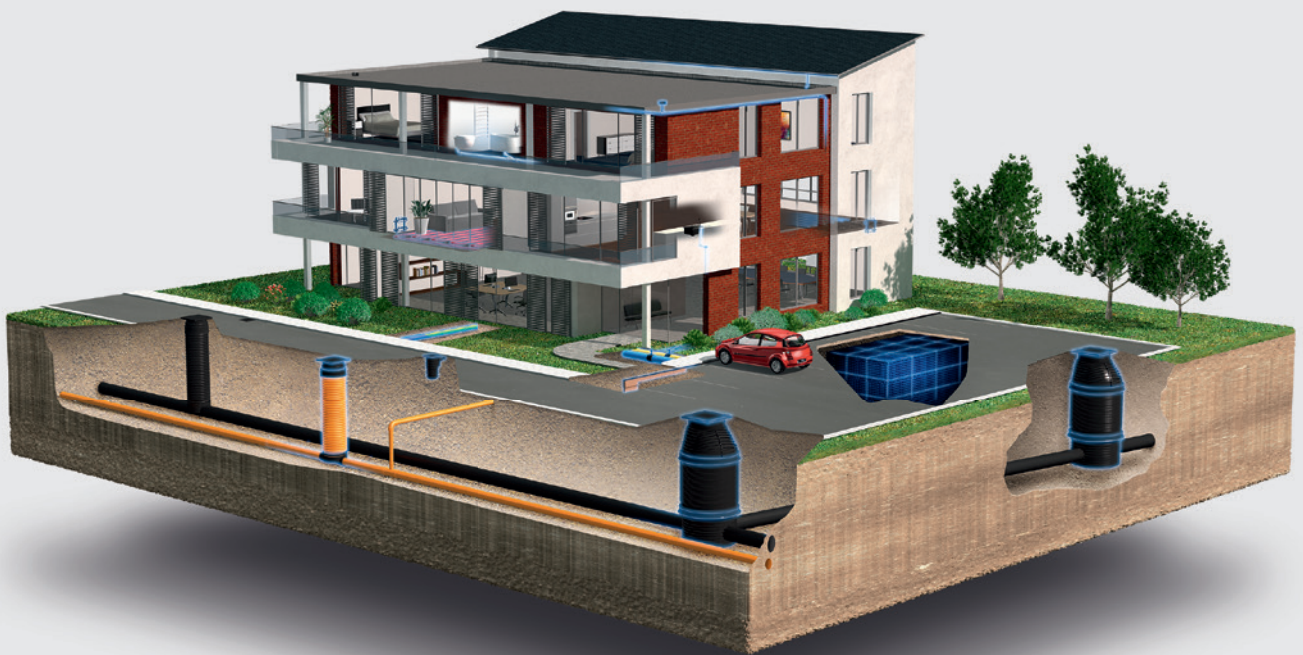

Water management | Heating and cooling | Water and gas distribution
Waste water drainage | Cable ducting



Wavin is part of Orbia, a community of companies working together to tackle some of the world's most complex challenges. We are bound by a common purpose: To Advance Life Around the World.



WAVIN ASIA PACIFIC E-mail wavinapac@wavin.com | Internet www.wavin.com/asia



© 2020 Wavin Wavin reserves the right to make alterations without prior notice. Due to continuous product development, changes in technical specifications may change. Installation must comply with the installation instructions.