

# Wavin PPR for water supply and heating

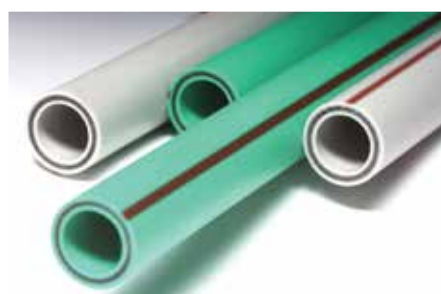

# Contents

## The Pilsa System

<b>1. Utilisation of Pilsa System</b>	Page	6
<b>2. Warranty Terms and Conditions</b>	Page	6
<b>3. Product Range – Basic Information</b>	Page	6-7
<b>4. Properties of Pilsa System</b>	Page	7
<b>4.1. Advantages</b>	Page	7
<b>4.2. Pilsa System Marking</b>	Page	7-8
<b>4.3. Specification of raw material used in production</b>	Page	8
<b>4.4. Product manufacturing and testing standards</b>	Page	6
<b>4.5. Pilsa System Certificates</b>	Page	8
<b>5. Assumed Media Properties in Piping Systems</b>	Page	8
<b>5.1. Basic parameters of internal water distribution systems</b>	Page	8
<b>5.2. Basic parameters of heating systems</b>	Page	8
<b>6. Operating parameters of Pilsa pipes</b>	Page	9
<b>7. Calculating the pipeline's service life within the system</b>	Page	10
<b>8. Pilsa Pipeline Routing Options</b>	Page	10-11

## Tables

<b>9. Tables</b>	Page	12
<b>9.1. Operating parameters of PPR and PP-RCT piping systems according to DIN 8077/2007</b>	Page	12
<b>9.2. Isothermal lines for PPR mechanical strength</b>	Page	13
<b>9.3. Isothermal lines for PP-RCT mechanical strength</b>	Page	14
<b>9.4. Operating conditions according to ISO 10508 - Application Classes</b>	Page	15

**Assembly instructions**

<b>10. Assembly Instructions</b>	Page 16
<b>10.1. General</b>	Page 16
<b>10.2. Linear expansion and contraction</b>	Page 17
<b>10.3. Spacing distance between pipe supports</b>	Page 22
<b>10.4. Pipe fixing</b>	Page 23
<b>10.5. Pipeline routing</b>	Page 24
<b>10.6. Making connections</b>	Page 26
<b>10.7. Insulation</b>	Page 27
<b>10.8. Pressure test</b>	Page 28

**Material Transport and Storage**

<b>11. Material Transport and Storage</b>	Page 28
---	---------

**Pressure Test Certificate**

<b>12. Pressure Test Certificate</b>	Page 29
--------------------------------------	---------

**Welding - Working procedures**

<b>13. Polyfusion Welding</b>	
<b>- Working Procedures</b>	Page 30
<b>14. Welding With Electrofusion Sockets</b>	
<b>- Working Procedures</b>	Page 33
<b>15. Repair of Damaged Piping</b>	Page 34
<b>16. Additional Branching</b>	Page 36
<b>17. Pressure Loss Tables</b>	Page 38
<b>18. Coefficient of Loss</b>	Page 49
<b>19. References</b>	Page 50

# PPR Product Range

## Pipes

### Pilsatherm

(L=4 Mt.)



Product Code: PPr

DIMENSION (mm)	SDR 11 S 5 t (10 Bar)	SDR 7.4 S 3.2 t (16 Bar)	SDR 6 S 2.5 t (20 Bar)
20	1.9	2.8	3.4
25	2.3	3.5	4.2
32	2.9	4.4	5.4
40	3.7	5.5	6.7
50	4.6	6.9	8.3
63	5.8	8.6	10.5
75	6.8	10.3	12.5
90	8.2	12.3	15.0
110	10.0	15.1	18.3
125	11.4	17.1	20.8
160	14.6	21.9	26.6
200	18.2	27.4	33.2

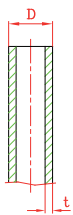

### Pilsa Plus

(L=4 Mt.)



Product Code: PP-RCT

DIMENSION (mm)	SDR 9 S 4 t (22 Bar)
20	2.3
25	2.8
32	3.6
40	4.5
50	5.6
63	7.1
75	8.4
90	10.1
110	12.3
125	14.0
160	17.9
200	22.4

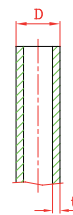

### Glass Fibered Reinforced

(L=4 Mt.)



Product Code: PPr GFR

DIMENSION (mm)	SDR 7.4 S 3.2 t (20 Bar)	SDR 6 S 2.5 t (25 Bar)
20	2.8	3.4
25	3.5	4.2
32	4.4	5.4
40	5.5	6.7
50		8.3
63		10.5
75		12.5
90		15.0
110		18.3
125		20.8

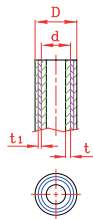

### Basalttherm

(L=4 Mt.)



Product Code: PPr Basalttherm

ØAP (mm)	SDR 9 S 4 t (20 Bar)	SDR 7.4 S 3.2 t (25 Bar)
20		2.8
25		3.5
32		4.4
40		5.5
50		6.9
63		8.6
75	8.4	
90	10.1	
110	12.3	
125	14	

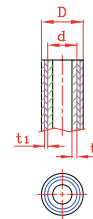

### Al Foiled(Perforated) Pipe

(L=4 Mt.)



Product Code: ALF PPr

DIMENSION (mm)	SDR 6 S 2.5 t (20 Bar)	SDR 5 S 2 t (25 Bar)
20	3.4	4.1
25	4.2	5.1
32	5.4	6.5
40	6.7	8.1
50	8.3	10.1
63	10.5	12.7
75	12.5	15.1
90	15.0	18.1
110	18.3	22.1

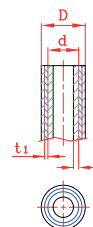

(\*) For color and dimension requests please ask to Wavin Pilsa

# Multilayer pipes made from PP-RC and PP-RCT

## Basalttherm

- 3x lesser thermal expansion
- no need to shave before welding
- hot water, heating

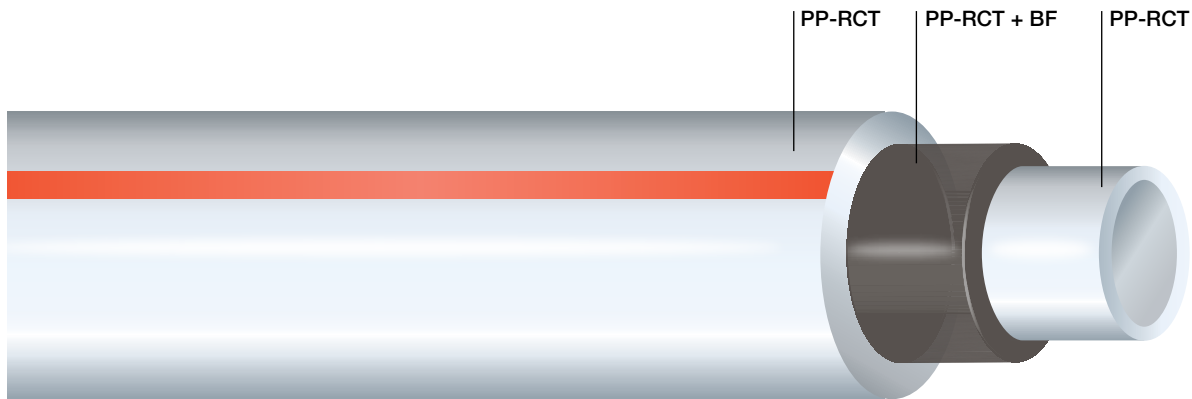

## Composite Pipe (PPR Glass Fiber)

- 3x lesser thermal expansion
- no need to shave before welding
- hot water, heating

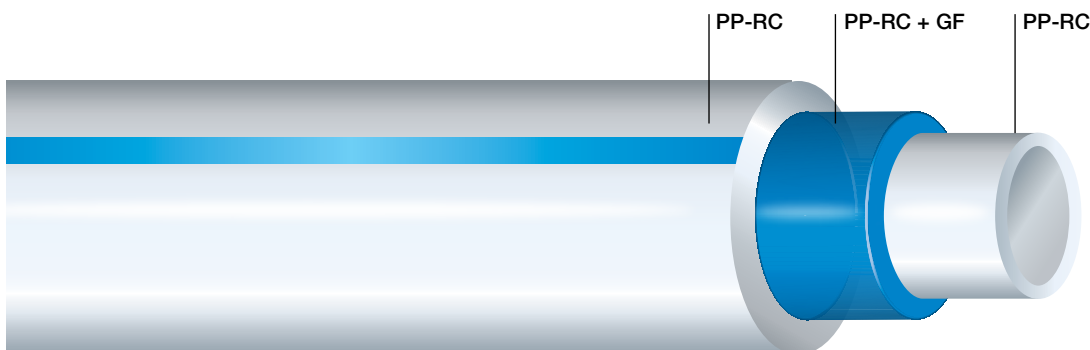

## Aluminium Foiled (Perforated)

- 4x lesser thermal expansion
- oxygen barrier
- heating

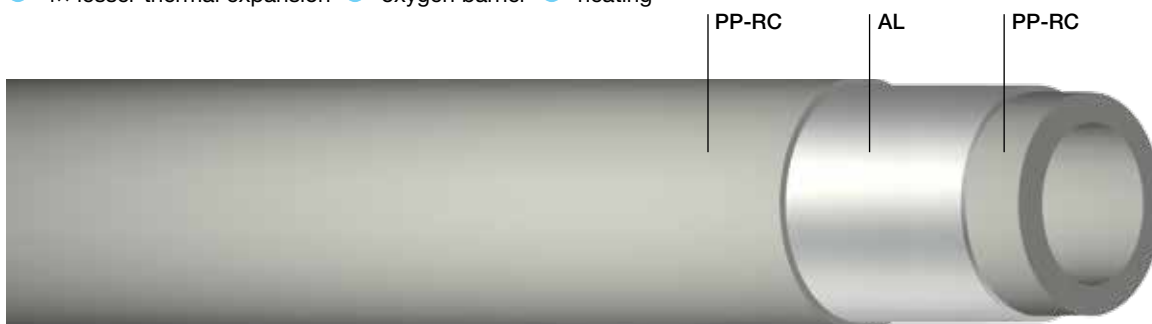

# The Pilsa System

## 1. Utilisation of Pilsa System

The Pilsa piping system can be used for distribution systems in housing, administration and community buildings as well as for industrial and agricultural installations. The system is designed for transport of cold and hot water as well as floor heating. In case of observance of the rules specified herein-after the system is also suitable for central heating systems.

The Pilsa System can also be used for air distribution. It is possible to take further advantage of its chemical resistance and other system properties and use the system for transport of other liquids or gaseous or solid media; such usage, however, must not be done without a prior individual assessment. Chemical disinfection of hot water must not be performed without a prior assessment by the manufacturer. Permanent disinfection of hot water with chlorine dioxide shortens the service life of the system and therefore is not recommended.

## 2. Warranty Terms and Conditions

**All standard elements of the Pilsa System are covered by a 10-year warranty period. This guarantee is subject to a proper product application and adherence to this installation manual. Twenty-four months guarantee period is granted for other products.**

There are separately mentioned standard elements for potable water and cold water and a separate standard element for cold water in the catalogue of products.

The warranty is only valid for installations consisting entirely of pipes and fittings from the Pilsa System. The warranty does not apply if the installation includes products from other manufacturers.

## 3. Product Range – Basic Information

Pipes and fittings of the Pilsa System are produced in the following sizes (external pipe diameter is shown): 20, 25, 32, 40, 50, 63, 75, 90, 110, 125, 160, 200 mm. The pipes are produced in various combinations of operating pressure and temperatures in separate pressure lines (of various wall thicknesses):

Fields of application according to the type of pipes

- ⦿ All plastic pipe (PPR)
  - S 5 (PN 10) for cold water and floor heating
  - S 4 (PN 12,5) for hot water and floor heating
  - S 3,2 (PN 16) for hot water and floor heating
  - S 2,5 (PN 20) for hot water and central heating
- ⦿ All plastic pipe Pilsa Plus (PP-RCT)
  - S4 (20-200 mm) , for cold and hot water, floor and central heating
- ⦿ Multilayer pipe (PPR-C) - Aluminium Foiled with perforated aluminium foil (20-110 mm, S 2,5), (20-110 mm, S 2) for hot water and central heating
- ⦿ Multilayer pipe (PP-RCT) – Basalttherm S 3,2 (20-63 mm), S 4 (75-125 mm) reinforced with basalt fiber, for hot water and central heating

### Note: diameters and S Class

The operating conditions of water distribution and heating are specified for four different classes of application (EN ISO 15874-1). Each class of application refers to a typical field of use and for a period of 50 years. Each class of application must be associated with the pressure it is designed for (operating system pressure). This information is assigned to each pipe in the following format: class of application/pressure, for example 1/10 bar. It means the pipe is categorized as class 1 and has the maximum operating pressure of 10 bar.

The classes of application according to EN ISO 15874-1

- ⦿ class 1 (supply of hot water of 60 °C, service life 50 years)
- ⦿ class 2 (supply of hot water of 70 °C, service life 50 years)
- ⦿ class 4 (floor heating, low temperature heaters, service life 50 years, assuming (in total for the entire lifetime) 2.5 years at the operating temperature of 20 °C, 20 years at the operating temperature of 40 °C, 25 years at the operating temperature of 60 °C, 2.5 years at the operating temperature of 70 °C)

- ⦿ class 5 (high temperature heaters, service life 50 years, out of which (in total for the entire length of service life) 14 years at the operating temperature of 20 °C, 25 years at the operating temperature of 60 °C, 10 years at the operating temperature of 80 °C, 1 year at the operating temperature 90 °C). Maximum operating pressure (4, 6, 8, 10 bar) corresponding to the application class is calculated and assigned for each material and pipe series S.

The Aluminium Foiled pipes are three-layer pipes: the inner wall of the pipe is made of polypropylene type 3 - PP-RC and its wall thickness is identical to that of the pipe S 2,5 and S 2. During the course of production it is coupled to the layer of aluminium and subsequently covered with an outer layer of polypropylene. The pipes have durability and thermal length expansion comparable to metal pipes. The PP-RC pipes are labeled according to the wall thickness as the class "S". In order to provide the aluminium foil with some mechanical protection the pipe is furnished with an external polypropylene layer.

The BASALTHERM pipes are three-layer pipes. The inner and outer layer is made of polypropylene type 4 (PP-RCT). The middle layer is from polypropylene type 4 (PP-RCT) reinforced with basalt fibers (BF). The composition of the layers can be schematically described as PP-RCT / PP-RCT + BF / PP-RCT. Due to the basalt fiber the thermal expansion occurring in the BASALT FIBER PLUS pipe is three times lower than in the all-plastic pipes. Fittings (and adaptors) are manufactured for all piping types in the highest PN 20 pressure range and in various configurations:

- ⦿ Full-plastic fittings (sockets, elbows, T-pieces reduced and full-sized, reducers, blindings, cross-pieces).
- ⦿ Combined fittings with brass, nickel-coated threads for threaded joints (reducing sleeves with metal thread, T-pieces, elbows for wall mounting, wall mounting groups with tap connectors, plastic reducing sleeves with cap nut)
- ⦿ Combined fittings for flanged joints
- ⦿ Plastic valves with brass throttle (classic and under-plaster types)
- ⦿ Ball valve with a chrome – plated mantle (classic and under-plaster types)
- ⦿ Special elements (crossovers, compensation pipes)

Equipment and accessories:

- ⦿ Tools (welding and cutting devices, scrapers, thermometers and assembly jig)
- ⦿ Fixing clips, metal sleeves, plastic and metal troughs and plugs.

For a detailed and updated list of components see our Product Catalogue.

## 4. Properties of Pilsa System

### 4.1. Advantages

- ⦿ Service life of more than 50 years subject to proper utilisation
- ⦿ No health risks
- ⦿ No corrosion or encrustation
- ⦿ Flexibility, low weight, easy and clean installation
- ⦿ Low-noise level, low pressure losses due to friction
- ⦿ Environmentally friendly product (can be recycled or safely incinerated)

### 4.2. Pilsa System Marking

Pipes and fittings are marked during the manufacturing process to enable future tracing. All elements are marked in the following way:

**Pipes:** WAVIN Pilsa, S and application class, size, wall thickness, manufacturing standard (EN ISO 15874 and specifications of use according to this standard, see an example on page 10), date of production and code of manufacturing line.

**Fittings:** Pilsa (abbreviations such as PL may be used), material PPR and size. Separate fitting packages are fitted with package labels containing not only the element type marking but also the date of production and releasing inspector's identification.

Pipes are marked according to the terms of EN ISO 15874 by code S – series (application class). Relationship between older PN pressure class marking, S and SDR for PPR pipes is listed in the table.



S	5	3,2	2,5	2
SDR	11	7,4	6	5
PN	10	16	20	25

The table can not be used for the new material PP-RCT because the pipes made from this material have better operating parameters (pressure, temperature, service life) than PPR pipes. The possibility to identify each element in a system is an important instrument of quality control management as well as an evidence for potential settlements of guarantee claims.

#### 4.3. Specification of raw material used in production

All plastic pipes PPR and fittings, Composite pipe and Aluminium Foiled pipes are manufactured from Type 3 polypropylene. All plastic pipes Pilsa Plus, multilayer pipes Basaltherm, are made from polypropylene of new generation - type 4, PP-RCT.

#### Selected characteristics of pipes

characteristics		units	PPR value
specific gravity	PPR, PP-RCT	g / cm <sup>3</sup>	0,9
thermal expansion coefficient (elongation)	all plastic pipes	mm / m °C	0,12
	multilayer pipes		0,05
thermal conductivity coefficient	all types of pipes	W / m °C	0,24

#### 4.4. Product manufacturing and testing standards

Pilsa PPR System products are manufactured according to EN ISO 15874.

The internal company standards are continuously being updated with further specification guidelines taken from the newly introduced European (EN) System of Standards. In order to meet quality requirements specified in ISO 9001, the following activities are regularly controlled within the frame-

work of specified procedures:

- ⦿ characteristics of raw materials entering the manufacturing process;
- ⦿ intermediate product parameters at every production stage
- ⦿ manufacturing facilities
- ⦿ parameters of measuring instruments

#### 4.5. Pilsa System Certification

Pilsa System is certified to the internationally recognized Standard TR EN ISO 15874.

#### 5. Assumed Properties of Piping System Agent

##### 5.1. Basic parameters of internal water distribution systems

A short-term overheating to higher temperature levels (70°C) is expected for hygienic reasons (extermination of pathogenic mycobacteria and bacteria Legionella pneumophila). Pilsa System can be used for all internal water distribution systems (i.e. cold drinking water, cold industrial water, hot water, circulation systems).

The plastic piping system is expected to have a 50 years service life under the condition that the material and piping have been selected correctly and the system properly installed. The pressure class depends on the hot water heating system and its proper regulation and should therefore be specified by the relevant project designer.

##### 5.2. Basic parameters of heating systems

When assessing the suitability of Pilsa PPR System elements, the temperature t<sub>1</sub> - the highest temperature in the whole system - should be used as the input value for calculation. The heating system designer will determine this value depending on the temperature level required at the entry, heat source parameters, and expansion vessel types. According to this value, the following heating system types are specified.



## 6. Operating parameters of Pilsa pipes

The operating parameters service life the maximum operating pressure, temperature and lifetime and the relationship between them. The operating parameters are based on the material strength isotherm (PPR or PP-RCT) see Tables 9.2 and 9.3 which show the dependence of the media temperature, service life of the pipe and pipe tension. For each individual types of pipes the tension values were converted to the operational pressures and processed in tabular form (page 10). Service life assessment can be performed by deducing the values from tables or by using isotherms (PPR or PP-RCT depending on the type of pipe).

The following data are necessary for such evaluation:

- ⦿ maximum water temperature [° C]
- ⦿ maximum operating pressure [MPa]
- ⦿ external diameter of the pipe [mm]
- ⦿ wall thickness of the pipe [mm]
- ⦿ safety factor for heating systems
- ⦿ annual length of the heating period (in months)

### Calculation of pipe service life in heating systems

In order to calculate service life, a value of life factored stress in the pipe wall should be determined according to the following formula

$$\sigma_v = \frac{p \cdot (D - s)}{2 \cdot s} \cdot k$$

indication	
$\sigma_v$	factored stress [MPa]
D	pipe external diameter [mm]
s	pipe wall thickness [mm]
p	maximum pressure [MPa]
k	safety factor [for heating systems 1.5]

For calculation purposes: 1 MPa = 10 bars

The determined value of the designed tension will be generated to the vertical line of the chart. See the intersection of this value (horizontal line) with the isotherm of maximum water temperature (oblique line). Lead the vertical line from the intersection vertically downward, perpendicular to the horizontal axis, where you can deduce the minimum service life of the pipeline under continuous operation.

**When installing plastic piping system behind a boiler or a water tank, we recommend to install 1,5 – 2 m of metal piping as protection against overheating the piping system.**

Another suitable design option in plastic piping utilisation is a common horizontal system where a pipeline is laid in a groove or along building structure in a cover (providing mechanical protection, allowing for expansion problems if any should occur, and improved visual appearance). Piping system designs should be also assessed with regard to their service life.

## 7. Calculating the pipeline's service life within the system

Input data

parameters	values
piping – selected type	PPR S 2,5 (PN 20)
max. operating water temperature annual length of the heating period	80 °C
max. operating pressure	0,22 MPa
yearly heating period	7 months
safety factor	1,5

$$\sigma_v = \frac{0,22 \cdot (20 - 3,4)}{2 \cdot 3,4} \cdot 1,5 = 0,80 \text{ MPa}$$

Minimum service life of a piping in continuous heating operation (as shown in the graph 9.2 for 80 °C isotherm) would then be 216,000 hours, i.e. 25 years. The resulting expected service life corrected to the annual heating period would then be as follows:

$$25 \text{ years} \cdot \frac{12 \text{ months}}{7 \text{ months}} = 43 \text{ years}$$

Heating system modifications applied in respect to piping service life. If the result received in the above procedures is not satisfactory, then the following modifications should be applied:

- 1/ decrease maximum operating pressure – new calculations should be made for the relevant heating system and service life expectancy; the modification should considerably extend service life expectancy.
- 2/ decrease maximum operating water temperature – new design calculations should be made for the relevant heating system and service life expectancy; the modification should considerably extend service life expectancy.

## 8. Pilsa Pipeline Routing Options

Routing options for water supply & distribution piping and heating systems are identical (leaving aside specific properties of heating systems as discussed in Chapter V and VII). The major aspects are the requirements for piping protection, support and compensation of expansion.

It is recommended that pipes are installed inside building structures (such as: wall, floor or ceiling structures) or covered. Connections to radiators should be, for visual appearance reasons, made of metal pipes, e.g. a chromium-coated copper pipe.

If the pipes are not covered and/or concealed it is necessary to take into account the fact that visible bubbles and blisters may appear on the Stabi pipes.

### Pipes can be laid:

- ⦿ in wall chases
- ⦿ in stack partitions
- ⦿ inside floor/ceiling structures
- ⦿ along walls (freely or inside covers)
- ⦿ in installation shafts and channels
- ⦿ outdoor piping applications should be considered
- ⦿ depending on local conditions

### Specific characteristic for underfloor heating

room (purpose)	max. surface floor temperature
living unit	26 °C
bathroom	30 °C
swimming pool surroundings	32 °C

Maximum surface temperatures of walk-on floor layers must comply with standards for floor heating systems installations.

Low flow rate levels of heating water (approx. 0.3 m.s-1) are designed for heat transfer in floor heating systems. Piping pressure is designed according to operating parameters of the whole heating system.

Temperature of heating water is determined by a calculation where room type, floor structure and estimated outdoor temperatures for the particular building are taken into account. Temperature and pressure levels are usually not higher than 45 °C, 0,3 MPa respectively. For these purposes Pilsa PPR S 5, S 4 or S 3,2 lines are normally used. Heating pipes are laid in a spiral shape pattern.

Pipe diameters and spacing distances can be calculated. It is also necessary to specify in the floor heating design the type of floor heating output control and ensure that the maximum floor surface temperature is not exceeded. In rooms where higher output is required and places where people usually do not stay for any extended period of time (under windows) the heating pipes are laid in a dense pattern. On the other hand, no pipes should be laid under built in furniture.

There is 100 meter maximum length of a heating coil per one heating circuit. Room sections with more heating circuits must be separated to allow for expansion (including walk-on layers). Floor structures must also be separated from walls.

Individual circuits start and end in a manifold. An air bleeding valve must be placed at the highest point of the whole system. To minimise running costs, floor coverings should be made of material of the lowest possible thermal resistance (tiled floor surfaces are usually the most suitable).

Piping position and spacing between pipe centres should be fixed in the course of installation works – pipes may be fixed to a metal network of thermal insulation system and locked into spacing channels or profiled thermal insulation system.

The installation process should follow the same rules and instructions that apply for water distribution systems installation.

During the course of the laying process the pipe should be carefully reeled off to prevent twisting. The pipe is then step-by-step fixed to the backing. Special attention should be paid to fixing the pipe to metal backing grids and care should be taken not to damage the pipe. Minimum temperature suitable for installation is 15 °C.

Floor heating is one of the most pleasant and effective heating methods. In order to make full use of all the advantages it offers, the heating system must be carefully designed and other factors should be taken into consideration as typically, the floor heating system would be only one of several types of heating used in the particular building.

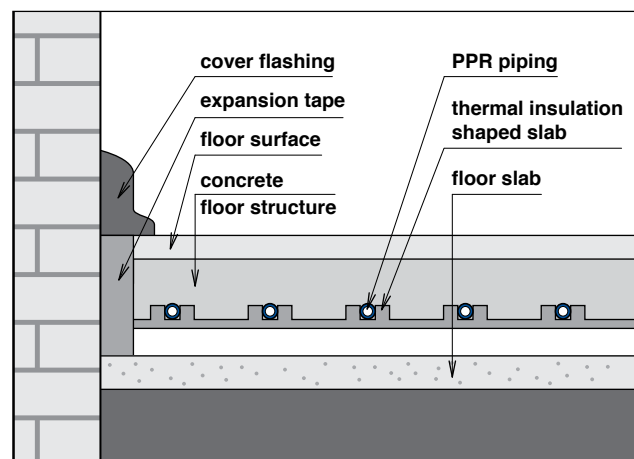

# Tables

## 9.1 Operating parameters of PPR and PP-RCT piping systems (according to DIN 8077/2007)

TEMPERATURE [°C]	TIME IN OPERATION (YEARS)	PILSATHERM			PP-RCT	
		S5 (PN10)	S2,5 (PN 20)	S 3,2 (PN 16)	BASALTHERM PILSA PLUS, COMPOSITE PIPE	
					S 4	S 3,2
MAXIMUM ALLOWABLE PRESSURE (BAR)						
10	1	17,5	35,1	27,8	24,0	30,2
	5	16,5	33,0	26,2	23,2	29,3
	10	16,1	32,2	25,6	22,9	28,9
	25	15,6	31,1	24,7	22,5	28,4
	50	15,2	30,3	24,1	22,2	28,0
20	1	15,0	29,9	23,7	20,9	26,3
	5	14,1	28,1	22,3	20,2	25,4
	10	13,7	27,4	21,7	19,9	25,1
	25	13,2	26,4	21,0	19,6	24,6
	50	12,9	25,7	20,4	19,3	24,3
30	1	12,7	25,4	20,2	18,1	22,7
	5	11,9	23,8	18,9	17,4	22,0
	10	11,6	23,2	18,4	17,2	21,7
	25	11,2	22,3	17,7	16,9	21,2
	50	10,9	21,7	17,2	16,6	20,9
40	1	10,8	21,6	17,1	15,5	19,6
	5	10,1	20,2	16,0	15,0	18,9
	10	9,8	19,6	15,5	14,7	18,6
	25	9,4	18,8	15,0	14,4	18,2
	50	9,2	18,3	14,5	14,2	17,9
50	1	9,1	18,2	14,5	13,3	16,7
	5	8,5	17,0	13,5	12,8	16,1
	10	8,2	16,5	13,1	12,6	15,8
	25	7,9	15,9	12,6	12,3	15,5
	50	7,7	15,4	12,2	12,1	15,2
60	1	7,7	15,4	12,2	11,2	14,2
	5	7,1	14,3	11,3	10,8	13,6
	10	6,9	13,9	11,0	10,6	13,4
	25	6,6	13,3	10,5	10,4	13,1
	50	6,4	12,9	10,2	10,2	12,8
70	1	6,5	12,9	10,3	9,4	11,9
	5	6,0	12,0	9,5	9,1	11,4
	10	5,8	11,6	9,2	8,9	11,2
	25	5,0	10,0	8,5	8,7	10,9
	50	4,2	8,5	6,7	8,5	10,7
80	1	5,4	10,8	8,6	7,9	9,9
	5	4,8	9,6	7,6	7,5	9,5
	10	4,0	8,1	6,4	7,4	9,3
	25	3,2	6,5	5,1	7,2	9,1
95	1	3,8	7,6	6,1	5,9	7,4
	5	2,6	5,2	4,1	5,6	7,1
COLD WATER						

SAFETY FACTOR 1,5

**9.2 Isothermal lines for PPR mechanical strength**

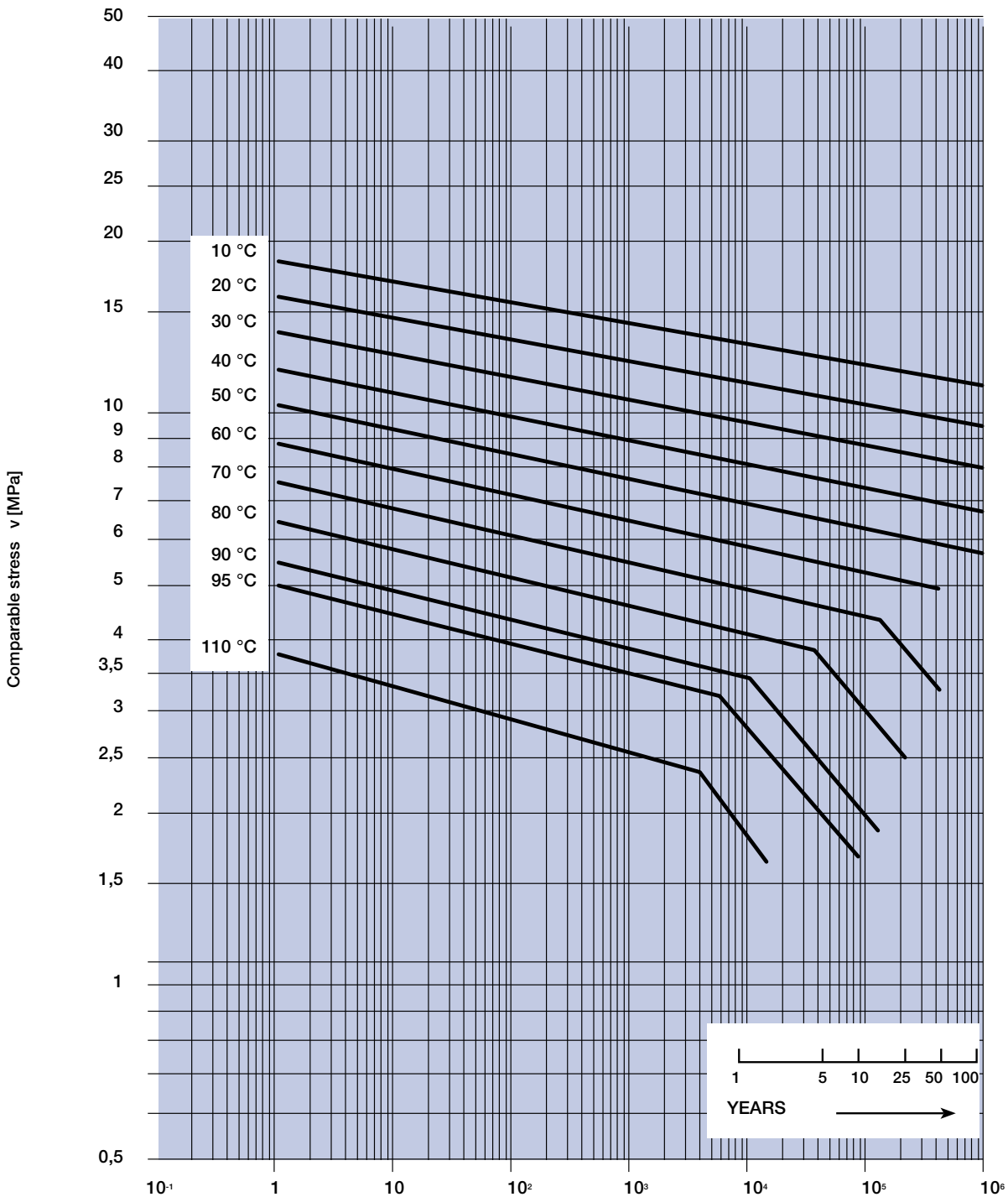

Termination of the isotherm indicates maximum service life even at lower tensions.  
The isotherms depicted in the chart are not extended.

### 9.3 Isothermal lines for PP-RCT mechanical strength

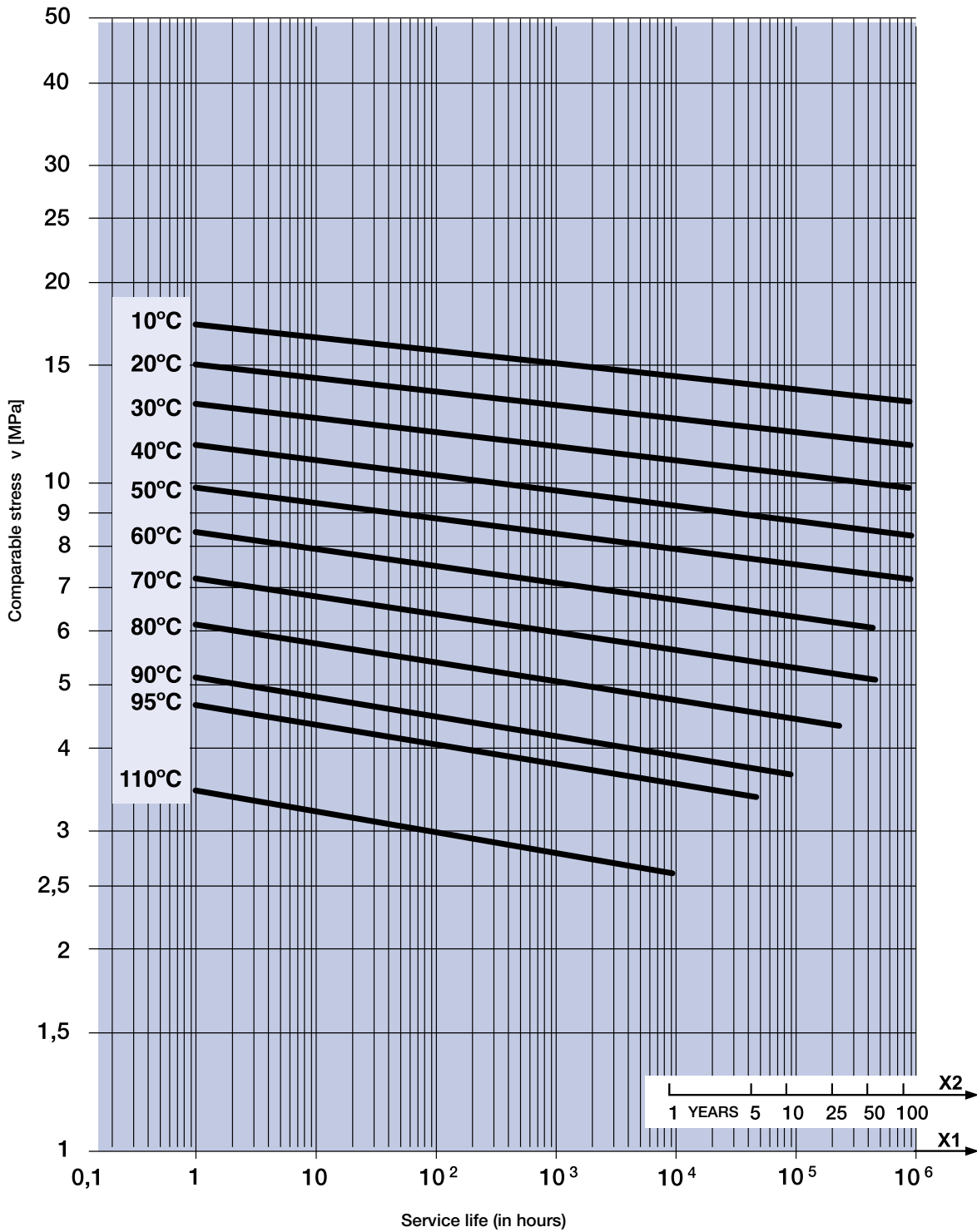

Termination of the isotherm indicates maximum service life even at lower tensions.  
The isotherms depicted in the chart are not extended.

## Operating conditions according to EN ISO 15874-1 - application classes

Each class has defined system operating parameters for the total usage period of 50 years. Time when distribution system is exposed to high temperatures (Tmax) and temperatures during functional failure of the system (Tmal) are also included. Pipes are assigned certain maximum operating

pressure. When more than one operating temperature applies for a particular class, the periods are summed - see Service Life Total. All pipes compliant with the conditions in the table are suitable for cold water distribution for the period of 50 years at 20 °C and the pressure of 10 bar.

Class	service life total (years)	time of operation years / hr	operating temperature T °C	typical use	PPR S 2,5 SDR 6 (PN 20)	PPR S 3,2 SDR 7,4 (PN 16)	PP-RCT S 3,2 SDR 7,4	PP-RCT S 4 SDR 9
					max. operating pressure (bar)			
1	50 years	49 years	60	hot water 60°C	10	8	10	8
		1 year	80					
	Tmal/service life by Tmal	100 hr	95					
2	50 years	49 years	70	hot water 70°C	8	6	10	8
		1 year	80					
	Tmal/service life by Tmal	100 hr	95					
4	50 years	2,5 years	20	floor heating low temperature radiators	10	10	10	8
		20 years	40					
		25 years	60					
		2,5 years	70					
	Tmal/service life by Tmal	100 hr	100					
5	50 years	14 years	20	high temperature radiators	6	x	8	6
		25 years	60					
		10 years	80					
		1 year	90					
	Tmal/service life by Tmal	100 hr	100					

Application classes and appropriate maximum operating pressures are listed in the description of each pipe.

Example: PP-RCT pipe – S 3,2:

- ⊙ Class 1/10 bar, 2/10 bar, 4/10 bar, 5/8 bar means that the pipe may be used:
- ⊙ for distribution of hot water of 60 °C - operating pressure 10 bar, service life of 50 years (class 1/10)
- ⊙ for distribution of hot water of 70 °C - operating pressure 10 bar, service life of 50 years (class 2/10)
- ⊙ for underfloor heating and low temperature radiators - operating pressure 10 bar, service life of 50 years (class 4/10)
- ⊙ for high temperature radiators - operating pressure 8 bar, service life of 50 years (class 5/8)



# Assembly instructions

## 10. Assembly Instructions

### 10.1. General

Only components not damaged or contaminated, either during storage or transport, may be used for installation works.

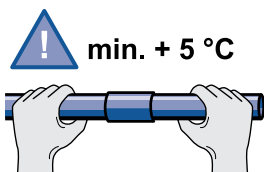

At lower temperatures it is difficult to provide proper working conditions for high-quality pipe coupling.

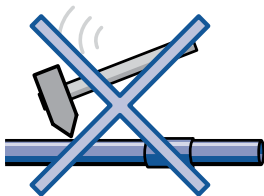

Components of plastic piping systems must be protected against damage during transport and installation.



Pipe bending should be done at +15 °C. For pipes of diameter range 16 – 32 mm a minimum bending radius equals to eight diameters (D).



Components must not be exposed to naked flames.

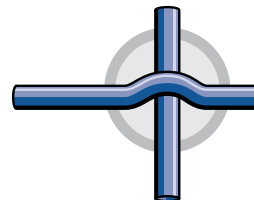

Pipeline cross-overs should be made with components designed explicitly for this purpose.



Plastic parts joining is done by polyfusion welding or by using electrofusion sockets and butt welding techniques. A high-quality homogeneous joint is the result. The welding process must follow proper procedures and must be performed with appropriate tools.

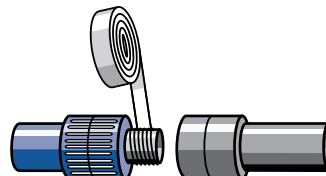

Threaded fittings must be used for screw-type joints. Threads should never be cut directly into plastic components. Threads are sealed with a special PTFE tape or sealing compounds.

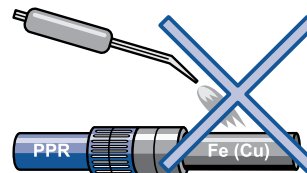

Brazing or soldering of metal fittings should not take place close to a joint between metal and plastic systems due to the potential hazard of heat transfer to the fitting.

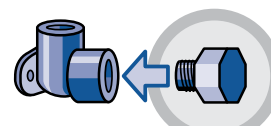

It is recommended to use plastic plugs for blanking elbows or wall mounting groups (plastic plugs are designated only for temporary use). Long term blanking requires using plugs with metal thread.

## 10.2. Linear expansion and contraction

Temperature differences during installation and under service conditions (i.e. when a medium flows through the system at a different temperature than that during the course of installation) result in linear changes – expansion or contraction ( $\Delta$ ).

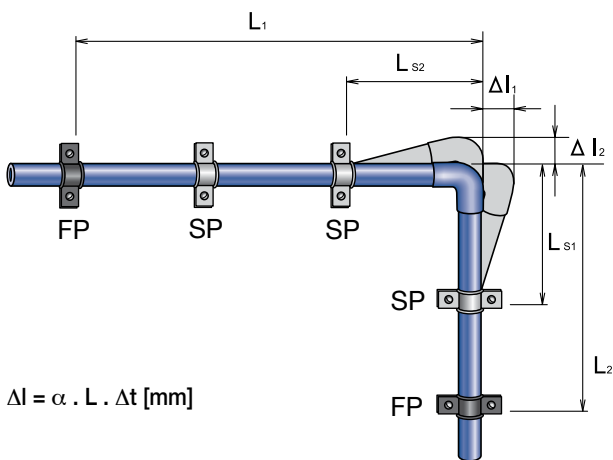

$$\Delta l = \alpha \cdot L \cdot \Delta t \text{ [mm]}$$

- $\Delta l$  linear change [mm]
- \* thermal expansion coefficient [mm/m °C] for all plastic pipes design purposes \* = 0,12  
for multilayer pipes Aluminium Foiled, Basalttherm, Composite Pipe respectively \* = 0,05
- L effective length (distance between two neighbouring fixed points in line) [m]
- $\Delta t$  installation and service temperature difference [°C]

$$L_s = k \cdot \sqrt{(D \cdot \Delta l)} \text{ [mm]}$$

- $L_s$  compensating length [mm]
- k material constant, for PPR k = 20
- D external diameter of the pipe [mm]
- $\Delta l$  linear change [mm]

If pipeline linear changes are not compensated in a suitable way, i.e. if the pipes cannot contract and expand, additional pressure and tensile stress accumulating in the pipes shortens their service life.

### Expansion U-bend

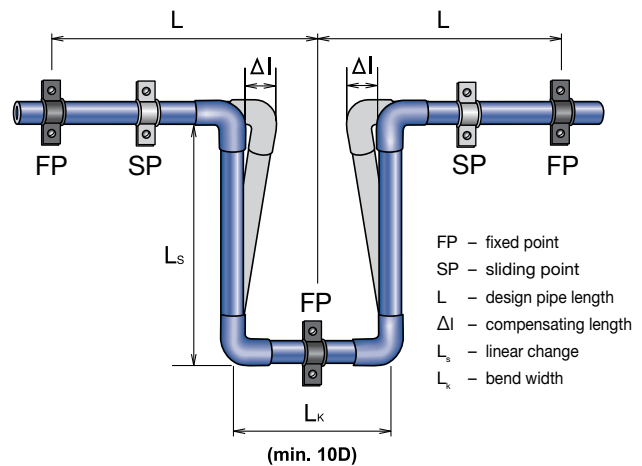

$$L_k = 2 \cdot \Delta l + 150 \text{ [mm]} \text{ and also } L_k \geq 10 \cdot D$$

In polypropylene applications linear compensation is often achieved through the pipe material's flexibility. Pipe bends can also be used for these purposes. One suitable compensation technique is where the pipeline is deflected perpendicularly to the original route and a free compensating length (marked as  $L_s$ ) is left at the normal line. The value of  $L_s$  compensating length depends on calculated route extension (shortening), pipe material and diameter. The values of  $\Delta l$  linear change and  $L_s$  compensating length can also be taken from the graphs shown on pages 17, 18 and 19.

### Compensation pipe table

pipe diameter (mm)	distances of all fixed L-points (m)	
	multilayer pipes	all plastic pipes
16	24	8
20	27	9
25	30	10
32	36	12
40	42	14

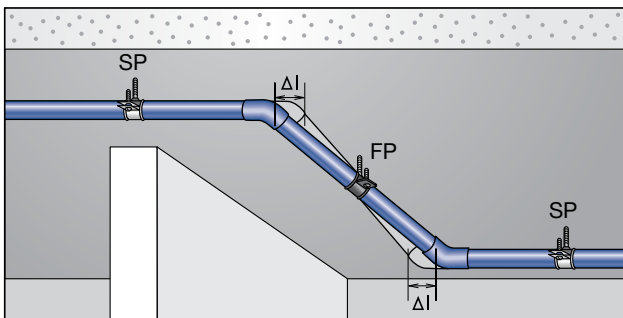
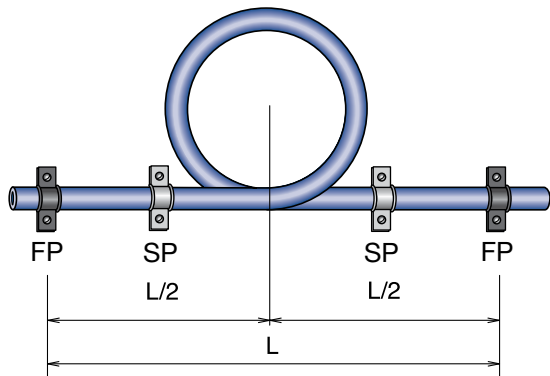

Example: Compensation through modified pipeline routing

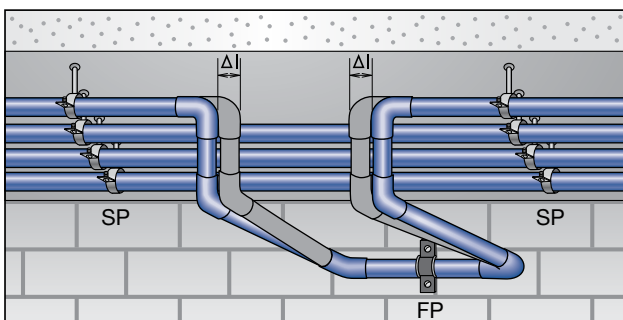

Example: Compensation through modified height of the pipeline.

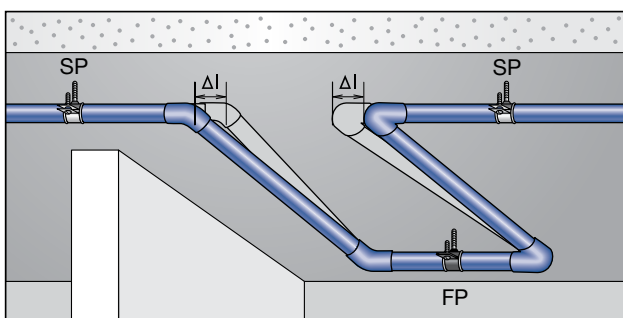

Compensating U-bend

### Calculation examples for Pilsa PPR piping

#### 1) Data input:

parameter	symbol	value	unit
linear change	$\Delta l$	?	mm
thermal expansion coefficient	$\alpha$	0,12	mm/m °C
pipe length	L	10	m
operating temperature inside the pipe	$t_p$	60	°C
temperature at installation	$t_m$	20	°C
difference between operating and installation temperature levels ( $\Delta t = t_p - t_m$ )	$\Delta t$	40	°C

Solution:  $\Delta l = \alpha \cdot L \cdot \Delta t$  [mm]  
 $\Delta l = 0,12 \cdot 10 \cdot 40 = \mathbf{48 \text{ mm}}$

#### 2) Data input:

parameter	symbol	value	unit
compensating length	$\Delta l$	?	mm
PPR material constant	k	20	-
external pipe diameter	D	40	mm
linear change as calculated above	$\Delta l$	48	mm

Solution:  $L_s = k \cdot \sqrt{D \cdot \Delta l}$  [mm]  
 $L_s = 20 \cdot \sqrt{40 \cdot 48} = \mathbf{876 \text{ mm}}$

#### 3) Data input:

parameter	symbol	value	unit
Compensating U-bend width			
external pipe diameter	D	40	mm
linear change as calculated above	$\Delta l$	48	mm

**Solution:**

$$L_{sp} = k \cdot \sqrt{(D \cdot l/2)} \text{ [mm]}$$

$$L_{sp} = 20 \cdot \sqrt{(40 \cdot 24)} = \mathbf{620 \text{ mm}}$$

Compensating length  $L_s$  ( $L_{sp}$ ) is understood as a length of pipe without any sustaining or suspending elements (on this length) obstructing expansion. The compensating length  $L_s$  ( $L_{sp}$ ) should not exceed max. spacing distance between supporting elements corresponding to the pipe diameter and media temperature as shown in Chapter 10, Part 10.3.

**Linear expansion of Pilsa - all plastic pipe**

Examples:  $L = 10\text{m}$ ,  $\Delta t = 40\text{ }^\circ\text{C}$

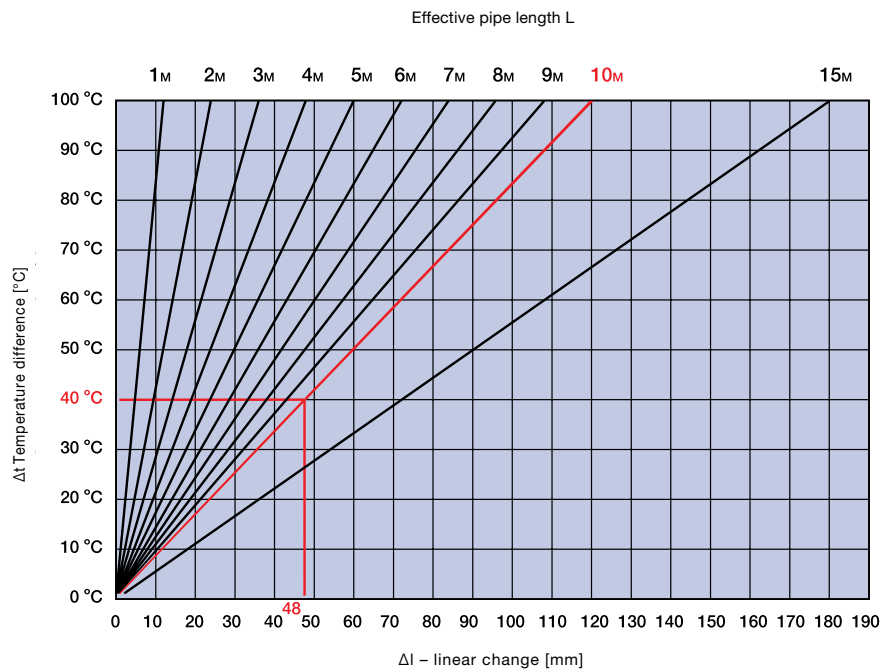

pipe length	temperature difference $\Delta t$							
	10 °C	20 °C	30 °C	40 °C	50 °C	60 °C	70 °C	80 °C
	linear change $\Delta l$ [mm]							
1 m	1	2	4	5	6	7	8	10
2 m	2	5	7	10	12	14	17	19
3 m	4	7	11	14	18	22	25	29
4 m	5	10	14	19	24	29	34	38
5 m	6	12	18	24	30	36	42	48
6 m	7	14	22	29	36	43	50	58
7 m	8	17	25	34	42	50	59	67
8 m	10	19	29	38	48	58	67	77
9 m	11	22	32	43	54	65	76	86
10 m	12	24	36	48	60	72	84	96
15 m	18	36	54	72	90	108	126	144

Rounded to whole numbers.

Linear expansion Pilsa PPR Aluminium Foiled, Basalttherm , Composite Pipe

Examples: L = 10m, Δt = 40 °C

Effective pipe length L

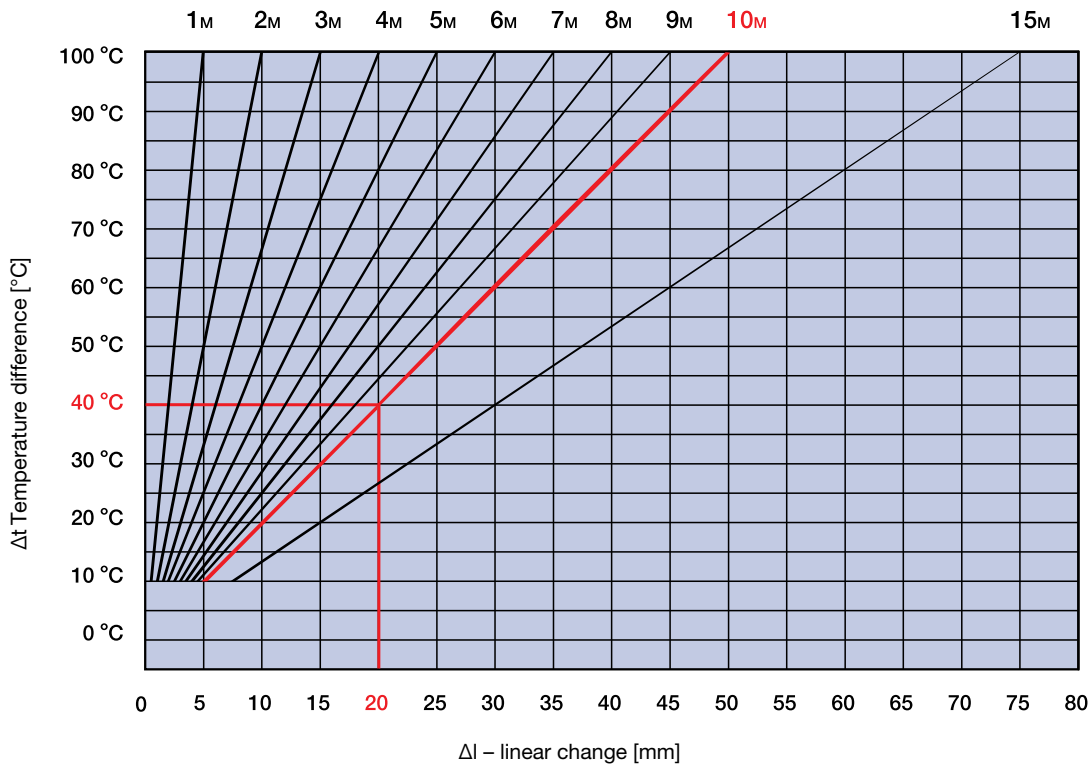

pipe length	temperature difference $\Delta t$							
	10 °C	20 °C	30 °C	40 °C	50 °C	60 °C	70 °C	80 °C
	linear change $\Delta l$ [mm]							
1 m	1	1	2	2	3	3	4	4
2 m	1	2	3	4	5	6	7	8
3 m	2	3	5	6	8	9	11	12
4 m	2	4	6	8	10	12	14	16
5 m	3	5	8	10	13	15	18	20
6 m	3	6	9	12	15	18	21	24
7 m	4	7	11	14	18	21	25	28
8 m	4	8	12	16	20	24	28	32
9 m	5	9	14	18	23	27	32	36
10 m	5	10	15	20	25	30	35	40
15 m	8	15	23	30	38	45	53	60

Rounded to whole numbers.

Determination of  $L_s$  – compensating length  
 Examples for pipe  $D = 40$  mm,  $\Delta l = 48$  mm

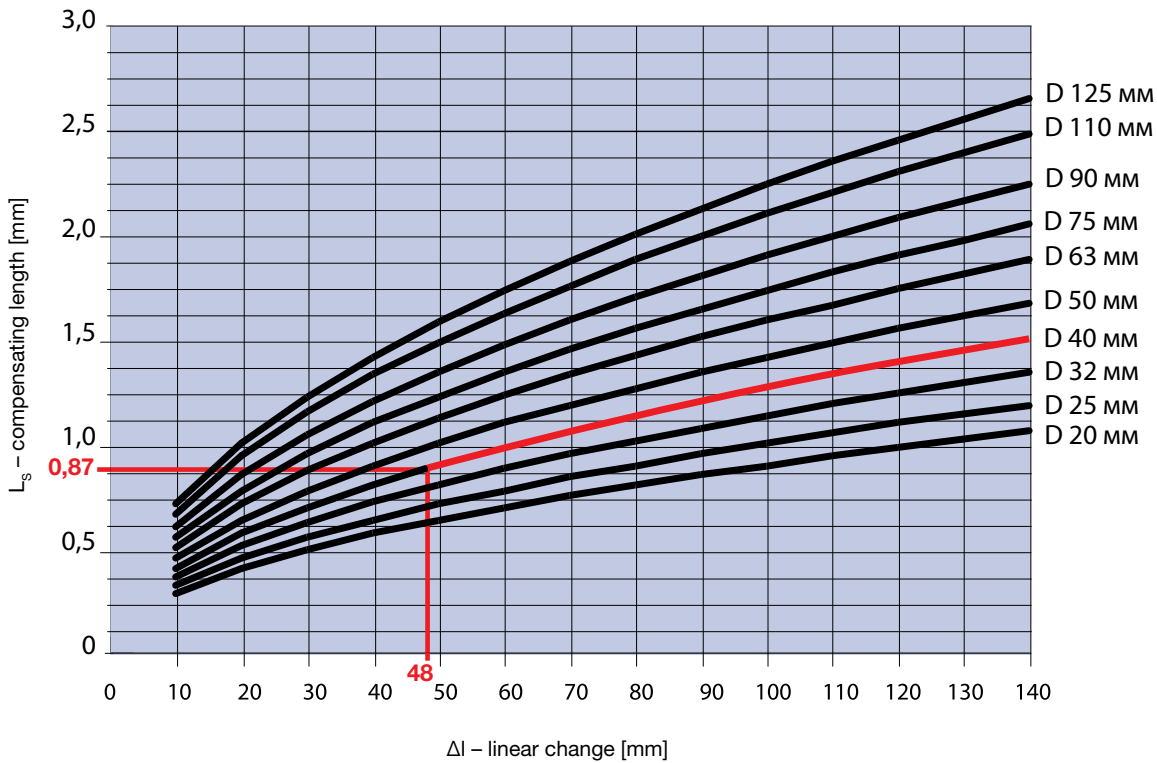

pipe diameter [mm]	$\Delta l$ – linear change [mm]													
	10	20	30	40	50	60	70	80	90	100	110	120	130	140
	$L_s$ – compensating length [mm]													
16	0,25	0,36	0,44	0,51	0,57	0,62	0,67	0,72	0,76	0,80	0,84	0,88	0,91	0,95
20	0,28	0,40	0,49	0,57	0,63	0,69	0,75	0,80	0,85	0,89	0,94	0,98	1,02	1,06
25	0,32	0,45	0,55	0,63	0,71	0,77	0,84	0,89	0,95	1,00	1,05	1,10	1,14	1,18
32	0,36	0,51	0,62	0,72	0,80	0,88	0,95	1,01	1,07	1,13	1,17	1,24	1,29	1,34
40	0,40	0,57	0,69	0,80	0,89	0,98	1,06	1,13	1,20	1,26	1,33	1,39	1,44	1,5
50	0,45	0,63	0,77	0,89	1,00	1,10	1,18	1,26	1,34	1,41	1,48	1,55	1,61	1,67
63	0,50	0,71	0,87	1,00	1,12	1,23	1,33	1,42	1,50	1,59	1,66	1,74	1,81	1,88
75	0,55	0,77	0,95	1,10	1,22	1,34	1,45	1,55	1,64	1,73	1,82	1,90	1,97	2,05
90	0,60	0,85	1,04	1,20	1,34	1,47	1,59	1,70	1,80	1,90	1,99	2,08	2,16	2,24
110	0,66	0,94	1,15	1,33	1,48	1,62	1,75	1,88	1,99	2,10	2,20	2,30	2,39	2,48
125	0,71	1,00	1,22	1,41	1,58	1,73	1,87	2,00	2,12	2,24	2,35	2,45	2,55	2,65

Rounded to whole numbers.

### 10.3. Spacing distance between pipe supports

Maximum pipeline supports spacing of Pilsa PPR S 5 (PN 10) pipe (horizontal pipeline)

Ø pipe [mm]	spacing distances in [cm] at temperature of					
	20 °C	30 °C	40 °C	50 °C	60 °C	80 °C
16	90	85	85	80	80	65
20	95	90	85	85	80	70
25	100	100	100	95	90	85
32	120	115	115	110	100	90
40	130	130	125	120	115	100
50	150	150	140	130	125	110
63	170	160	155	150	145	125
75	185	180	175	160	155	140
90	200	200	185	180	175	150
110	220	215	210	195	190	165
125	235	230	225	210	200	170

Maximum distances of supports of pipeline Pilsa PPR S 3,2 (PN 16) pipe (horizontal pipeline)

Ø pipe [mm]	spacing distances in [cm] at temperature of					
	20 °C	30 °C	40 °C	50 °C	60 °C	80 °C
16	80	75	75	70	70	60
20	90	80	80	80	70	65
25	95	95	95	90	80	75
32	110	105	105	100	95	80
40	120	120	115	105	100	95
50	135	130	125	120	115	100
63	155	150	145	135	130	115
75	170	165	160	150	145	125
90	180	180	170	165	160	135
110	200	195	190	180	175	155
125	220	215	200	195	190	165

Maximum pipeline supports spacing of Pilsa PPR S 5 (PN 10) pipe (horizontal pipeline)

Ø pipe [mm]	spacing distances [in cm] at temperature of	
	20 °C	30 °C
20	80	75
25	85	85
32	100	95
40	110	110
50	125	120
63	140	135
75	155	150
90	165	165
110	185	180
125	200	195

Maximum distances of supports of pipeline Pilsa Plus (S 3,2, S 4)

Ø pipe [mm]	spacing distances [in cm] at temperature of						
	20 °C	30 °C	40 °C	50 °C	60 °C	80 °C	
16	80	75	75	70	70	60	
20	85	80	75	75	70	65	
25	90	90	90	85	80	75	
32	105	100	100	95	90	80	
40	115	115	110	105	100	90	
50	130	125	120	115	110	95	
63	145	140	135	130	125	110	
75	160	155	150	140	135	120	
90	170	170	160	155	150	130	
110	190	185	180	170	165	145	
125	205	200	190	185	180	160	

Maximum spacing distances Aluminium Foiled, Basalttherm independently of water temperature

Ø pipe [mm]	spacing distances [in cm] at temperature of	
	Aluminium Foiled	FIBER BASALT PLUS
16	110	
20	120	80
25	140	100
32	145	110
40	150	120
50	155	130
63	165	150
75	170	145
90	190	155
110	205	160
125	220	165

Maximum spacing distances between supports for vertically oriented pipelines should be multiplied by 1.3.



## 10.4. Pipe fixing

Pipeline route design must be appropriate for the system material, which means that the thermal coefficient of expansion, expansion allowance, given operating conditions (combination of pressure and temperature levels) and the type of pipe joints must be all taken into account. Pipeline systems should be fastened with both fixed and slidably mounted fixture points, allowing for appropriate linear expansion of the pipe.

### Pipe fixing techniques

Pipe fixing is generally done through two types of supports:

#### Fixed points (FP):

This is a type of fastening where no allowance for pipe expansion is made, i.e. the pipe cannot move along its axis in the place of support (cannot slide).

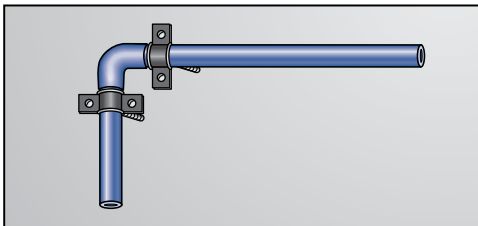

– at a pipe bend

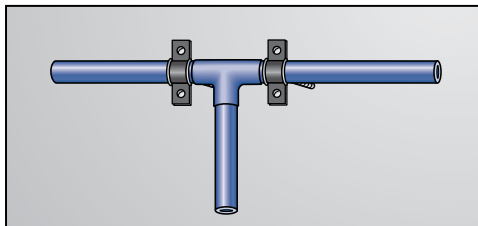

– at a branching point

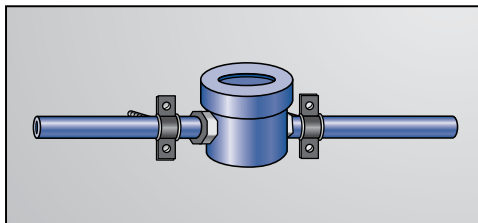

– at a fitting installation

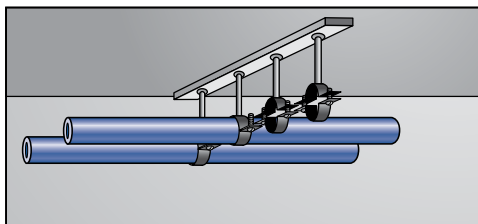

– by tightly drawn pipe-straps (only for horizontal piping)

#### Sliding point (SP):

This is a type of fixing where the pipe is not allowed to move sideways but expansion movements are not restricted (elongation, shrinkage). Slidable mounting can be designed as follows

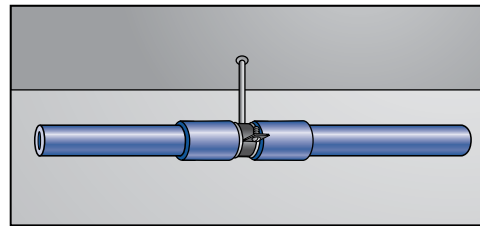

– by a sleeve between pipe fittings

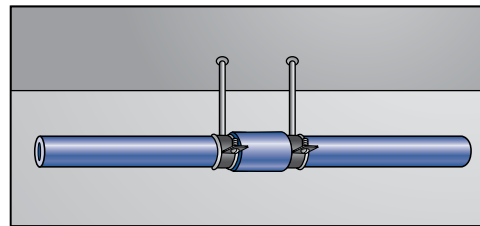

– by fixing at fitting places

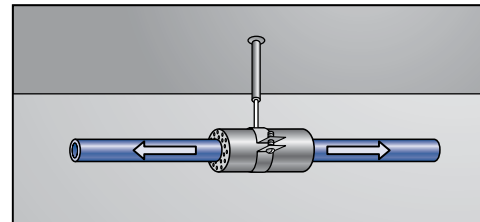

– by loose pipe-straps

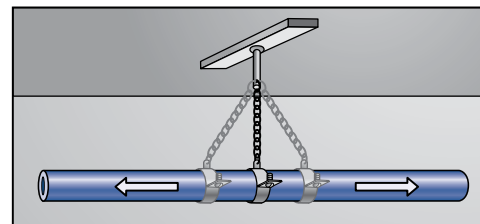

– by pipe-straps suspended on hooks

#### Application of plastic clips



Suitable for H&C water supply



For hot water, the clip must be one size larger than the pipe (needs to be fitted over the insulation).

### Other methods of plastic pipeline routing

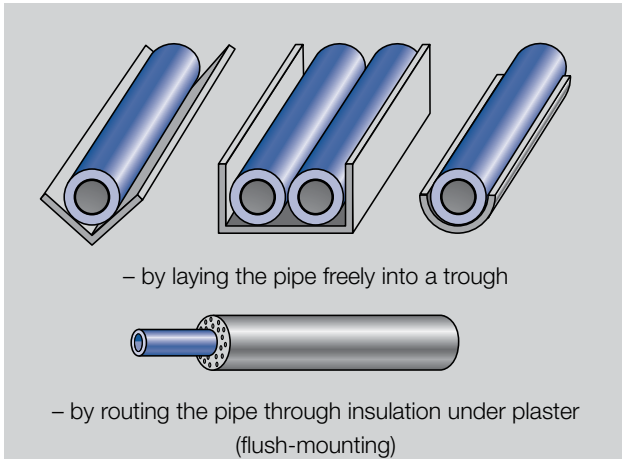

### 10.5. Pipeline routing

Pipes should be installed with a minimum gradient of 0.5 % towards the lowest system points, where the system can be vented through a drain faucet or shut off valve with an outlet. The piping system must be divided into separate parts that can be closed if necessary. Straight valves and plastic ball taps are used for this purpose. Shut off valves or ball taps are used when routing under the plaster. It is necessary to test the fittings' functionality (closing/opening) before installation.



It is recommended to use a wall mounting group with tap connectors at the end point with installed valve mixers. WALL MOUNTING GROUP WITH TAP CONNECTORS FOR GYPSUM WALL – with exact hole spacing 20 x 1/2" (code SNKK020SXX) is designed for installations where stabilization grooves are not used (e.g. installing into a gypsum wall). The hole spacing is the same as in valve mixers, and it can be adjusted to 100, 135, 150 mm. When routing the piping system into the wall, it is advisable to use the WALL MOUNTING GROUP WITH TAP CONNECTORS 20 x 1/2" (code SNKK020XXX) or 25 x 1/2" (code SNKK025XXX), where

the hole spacing is shifted in a way allowing the piping to be adjusted by mounting extensions. For valve mixers it is possible to use spacing of 150, 135, and 100 mm. Using this set ensures the installation process will be fast and precise, without any inaccuracies. If the distribution piping ends with pipe bends, it is necessary to ensure their fixed and accurate positioning. If two wall-mounted bends are installed for dispensing valve mixers (bath tube, shower and washbasin mixers) their identical height and parallel pipe fitting axis must be ensured. The wall-mounted group with tap connectors must not be exposed to torsion load resulting from dispensing mixers installation. It is therefore recommended to mount the elements to assembling on-wall plates, which helps to keep their exact positioning. The assembling plates have installation holes for plate installation matching the common spacing sizes of dispensing valve mixers.

### Routing of Pilsa PPR inlet piping

Inlet piping systems are made mainly from 16 – 20 mm diameter pipes, usually laid in wall channels. The channel meant for insulated pipe routing must be free of obstacles and allow some room for expansion. Aside from its thermal properties, the insulation system also protects the pipe against mechanical damage and the insulation layer helps to compensate any piping expansion. It is recommended to use expanded polystyrene or polyurethane (foam) for insulation. Before sealing off the pipes inside the wall, the piping system must be firmly fixed to the channel either by plastic or metal pipe-straps, or by plastering.

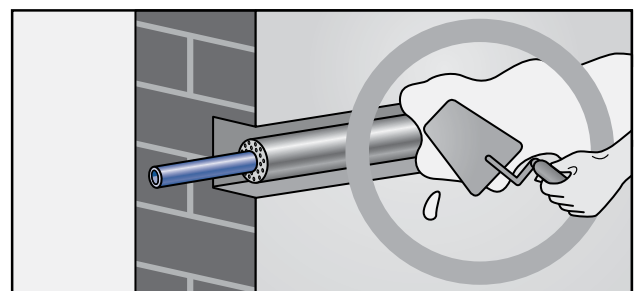

If water supply / distribution piping systems are installed inside stack partitions, they must be fixed in a suitable way – such as with a system of metal clips and supporting elements. The systems must be insulated and correctly positioned, allowing for expansion. If water supply /distribution piping systems are installed inside floor/ceiling structures, then flexible plastic protective sleeves (made of polyethylene) are used for protection against mechanical damage, while the air layer

between the sleeve and the pipe works as thermal insulation. Freely laid piping systems are rarely used for short distances in areas where visual appearance is not a priority (laundry facilities, service areas, etc.).

Supporting elements must be positioned with necessary care to fix the piping and take into account necessary pipe expansion compensation in connecting sections, where the pipes are sealed off. A good piping insulation system is also indispensable (if, for instance, a cold water pipe is laid freely on a wall located in a heated area, there will be a considerable risk of surface condensation). Piping systems may be laid freely on walls where there is no risk of mechanical damage in normal operating conditions.

### Routing of Pilsa PPR riser piping

In the case of riser piping it is necessary to consider precisely the layout of fixed points and sliding points, as well as create of a suitable expansion compensation system. The adjustments for expansion in riser piping systems are provided as follows:

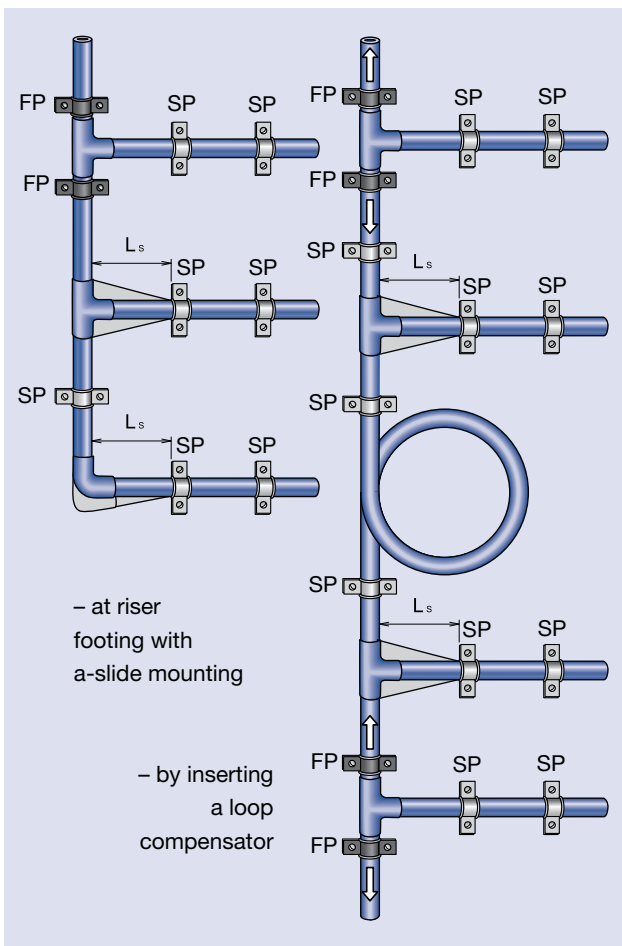

If it is necessary to divide the riser into several expansion sections, then it can be achieved by placing fixed points. The riser fixed points are always fixed under and over the T-pieces at a branch pipe or a socket, which also prevents the riser from falling. The pipe expansion must be accounted for between these fixed points as follows:

In branching off the feeder piping it is necessary to allow for riser expansion by:

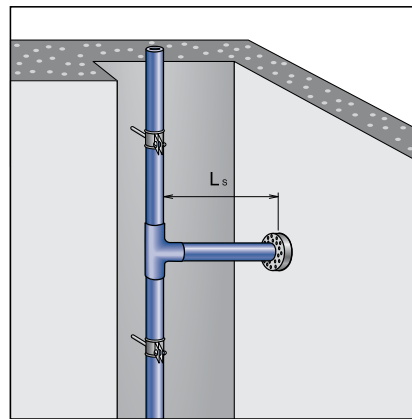

– keeping a sufficient distance from the wall pass-through point

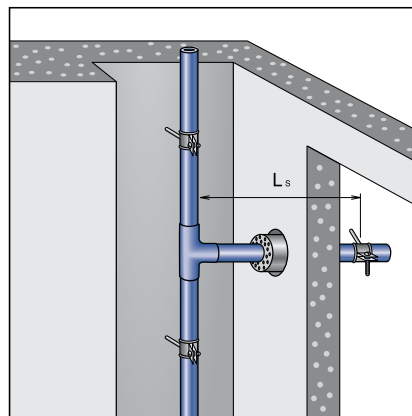

– allowing a certain degree of movement for the branch pipe in the wall pass-through point

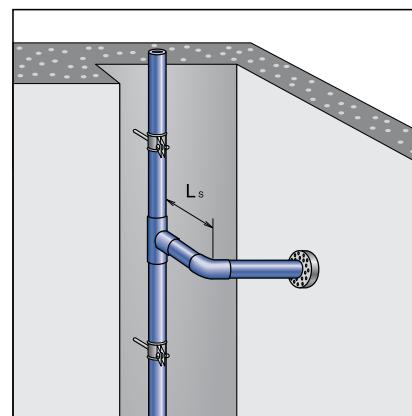

– creating a compensating length, allowing for vertical expansion at the riser

### Routing of horizontal Pilsa PPR piping

With horizontal piping systems, it is necessary to pay very close attention to their expansion conditions and how to lay the piping correctly.

The most common routing is done with galvanised metal or plastic troughs, sleeves, or in-wall channels (these must be kept free from any obstructions).

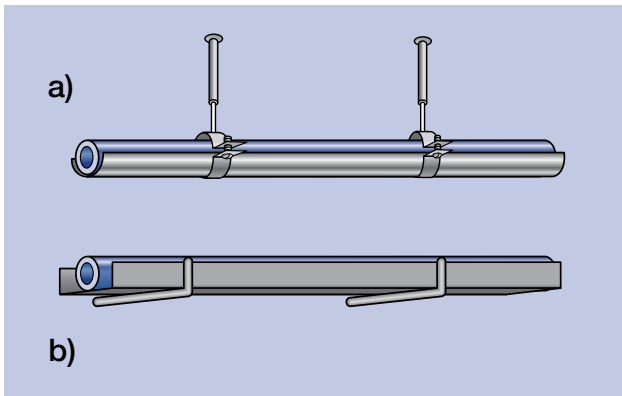

Expansion is most commonly compensated by a change in the routing or through expansion U-bends, but it is also possible to use a loop compensator for the same purpose. Expansion adjustment may be designed both in perpendicular and parallel plane to the ceiling structures. In the option a) a pipe is insulated (see Chapter 10, Part 10.7.) together with the trough right on the spot, while in the option b) a fully insulated pipe is laid into the trough.

### Routing of Pilsa Aluminium Foiled, Basalttherm inlet piping, Composite Pipe

Aluminium Foiled, Basalttherm and FIBER BASALT CLIMA have a three times lesser expansion, higher rigidity and better mechanic resistance than the all-plastic pipes. Aluminium Foiled, Basalttherm and FIBER BASALT CLIMA can be installed in the same way as the all-plastic systems (as described above), i.e. with conventional expansion adjustments, except with potentially greater support spacing and shorter expansion and adjustment lengths.

When routing inside the in-wall channels, the so-called “rigid” assembly can be used, which means the pipe is secured to fixed points so the thermal expansion is transferred to the piping material and thus remains unnoticeable. This type of installation however requires firmly anchored sleeves, capable of holding and supporting the piping system.

## 10.6. Making connections

The Pilsa pipeline system can be coupled by welding or mechanic coupling. Coupling of pipes and fittings is done in the same way in all types of pipes – the fittings are the same. With Pilsa Aluminium Foiled pipes, it is necessary to remove the upper PPR and middle aluminium layers along the fitting insertion length (using special shavers) before starting any welding operations.

### Welding

Polyfusion welding, electrofusion sockets, or butt welding techniques can all be used. All the techniques must be performed accurately and according to standard working procedures, using reliable, well-checked and well-maintained tools.

### Pipe cutting

Pipes can be cut by saws or shears. The cutting tools must be in good condition and sharp. Special shears or plastic pipe cutters are recommended.



### Threaded couplings, plastic/metal couplings

Plastic/metal couplings in hot water piping and heating systems contain pressed-in brass nickel-coated threads (both external and internal).



If a coupling is not fitted with a hexa- or multigonal piece directly on its metal part, tightening wrenches with a tape should be used.

### WARNING:

For thermal/technical and physical/mechanical reasons, usage of plastic threaded couplings is not permissible in sanitary engineering. Plastic threaded couplings may be used, for instance, in provisional distribution systems.

Plastic plugs should be used to close elbows for wall mounting and universal wall mounting groups with tap connectors until dispenser pipe fittings (valves) are installed.

### Sealing of couplings

Threaded couplings may be sealed with a teflon tape, sealing teflon fibre, or special sealant only.

### 10.7. Insulation

While hot water piping systems and heating systems are insulated against heat loss, the cold water pipes are conversely insulated against heat gain and pipe condensation. Cold water system insulation is necessary, as drinking water health requirements demand that the temperature level be kept under 20 °C. Similarly, the hot water temperature must be below the upper limit given by the standard of protection against scalding, though the temperature limits are also aimed at keeping the bacteria populations under control. Specialized technical solutions aside (such as thermal sterilisation), properly functioning circulation and keeping hot water at the required temperature level are both crucial for protection against bacteria such as Legionella pneumophila.

The thickness and type of insulation layers are determined on the basis of thermal resistance of the insulation system to be used, air humidity in the area of the piping system and the difference between the room temperature (air) and that of the flowing water.

The piping system must be insulated along its whole length, including fittings and valves. It is necessary to maintain a minimum insulation layer thickness along both the pipe diameter and the pipeline length; this means the insulation types that are cut lengthwise to be wrapped over the pipes must be thoroughly sealed after the installation (e.g. using an adhesive, clamps or a sealing tape).

### Minimum thermal insulation layer for cold water system – example

Placement / routing of pipes	insulation layer thickness ● = 0,040 W/mK
freely laid pipes in unheated areas (basement areas, for example)	4 mm
freely laid pipes in heated areas	9 mm
pipes in crawlways without concurrently running hot water lines	4 mm
pipes in crawlways with concurrently running hot water lines	13 mm
independently running underplaster pipes (in channels)	4 mm
underplaster pipes (in channels) running in parallel with hot water lines	13 mm
pipes cast over with concrete	4 mm

### Note:

the above thickness values must be re-calculated for other thermal characteristics

Usage of plastic pipes in such systems may therefore present a significant cost-saving solution!

In highly demanding systems (such as in bathrooms, bathtubs, washing machines, etc.) heat losses in plastic pipes with flowing water can be up to 20 % smaller than in metal ones. Another 15% can be saved by thorough insulation. In systems with small and/or short-time demand, where pipes are not regularly heated to operating temperatures, the savings will be smaller (only 10 %) although up to 20% can be expected at peak demand.

The insulation layer thickness for hot water systems usually ranges between 9 and 15 mm at the value of thermal resistance ● = 0.040 W/mK.

# Material, transport and storage

## 10.8. Pressure test

The distribution system can be filled with water no sooner than one hour after the last weld was performed. After the system is complete, a pressure test must be performed under the following conditions:

testing pressure:	min. 1,5 MPa (15 bar)
test commencement:	min. 12 hour after bleeding and additional pressurizing of the system
test duration time:	60 minutes
max. pressure drop:	0,02 MPa (0,2 bar)

Any piping system prepared for this test must be clean, laid according to the design, and visible along its whole length. The system is tested without hydrants and water-meters (flow-meters) and other valves /pipe fittings with the exception of bleeding equipment. Already installed closing valves should be left open. Water dispensing fittings may be installed only if they conform to the testing pressure; though under standard conditions they are usually replaced with plugs. The piping system is filled from the lowest point so that all bleeding points are open from the beginning and then sequentially closed once water running out of them is without air bubbles. The pipeline testing length is usually determined depending on local conditions, with recommended max. length being 100 metres.

After filling the system with water the internal water system is stabilized with operating overpressure for least 12 hours; after this period the overpressure is increased to 15 bars (testing overpressure). The pressure test lasts 60 minutes and maximum allowable pressure drop is 0.02 MPa. If the value of pressure drop is higher then the leak must be discovered, relevant defect fixed, and a new pressure test must be performed. A test record must be taken, for instance in the form of Pressure Test Certificate (see Chapter XII). This record/certificate is one of the documents required for filing any warranty claim.

## 11. Material Transport and Storage

The system components must be protected against weather, UV radiation and contamination.

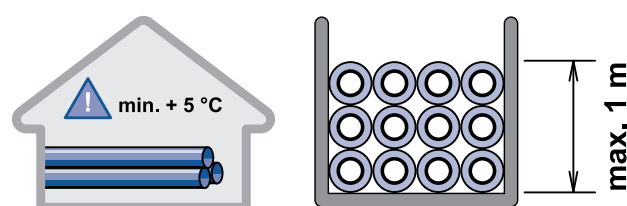

Stores of plastic components must be separated from such areas where solvents, adhesives, paints or similar products are stored.

It is recommended to store the components at minimum temperature of 5°C. If the temperature is lower than 5°C, it is necessary to be careful at pipeline manipulation. Plastic pipes in stock must be supported along their whole lengths or protected in another suitable way against deflection. Plastic pipe fittings are usually stored in sacks on pallets or freely loaded in boxes, containers, baskets, etc. Maximum storage height of one metre must be respected if plastic pipes are stored in plastic sleeves and/or pipe fittings in plastic sacks. Each of the different types of pipes and fittings are stored separately. When dispatching from storage, the oldest stock should be dispatched first.

During their transport it is not allowed to drag pipes over the ground or lorry deck. The components/pipes must not be transported by throwing or letting them fall off the lorry to the ground. If they are transported to/on the site then they must be protected against mechanical damage and stored at the spot on a suitable underlay where protected against dirt, solvents, direct heat (contact with a radiator, etc.). The components are supplied in protective covers (pipes in polyethylene bags, pipe fittings also in sacks or cardboard boxes) and it is desirable to let them in these as long as possible before the start of installation works (to protect them against dirt and other contamination).

# Pressure Test Certificate

## 12. Pressure Test Certificate

Description of installed system:

Place:

Building / structure:

### PRESSURE TEST CERTIFICATE

Installed length of piping systems

Pilsa pipe diameter [mm]	pipe / line length [m]	pressure class	description of pipe
16			
20			
25			
32			
40			
50			
63			
75			
90			
110			
125			

The highest outlet point.....m above pressure gauge

**Pressure test:**

Test started on / day: ..... time: .....

Testing pressure:..... MPa (test start)

Pressure after 1 hour: ..... MPa

Pressure drop during the test ..... MPa

Test ended at/day: ..... time: .....

Result: .....

Client: \_\_\_\_\_ (signature confirms the installation was accepted without defects)

\_\_\_\_\_ place

\_\_\_\_\_ date

\_\_\_\_\_ rubber stamp & signature

Contractor: .....

\_\_\_\_\_ place

\_\_\_\_\_ date

\_\_\_\_\_ rubber stamp & signature



# Welding – Working Procedures

## 13. Polyfusion Welding – Working Procedures

### Tools

- 1/ Electric polyfusion welding machine fitted with welding adapters of suitable dimensions, incl. a movable feeder cable.
- 2/ Contact thermometer.
- 3/ Special shears or cutter (i.e. jaw with a cutting wheel); metal hand saw if nothing else is available.
- 4/ Sharp penknife with short blade.
- 5/ Textile rag (non-synthetic material only).
- 6/ Degreaser (Tangit, Spirit).
- 7/ Folding ruler + marker.
- 8/ Scraper and assembly jig for welding of diameters over 50 mm.
- 9/ Pipe shaver (when welding Pilsa Stabi pipes).

### Tool check

First, attach the welding adapter to the welding machine (usually done with screws, depending on the type of the welding machine). With the welder controller set the temperature at 250 – 270 °C and connect the power supply. Time necessary to heat up the welding machine will depend on ambient conditions. Once the welding machine is warm, clean the welding adapters of impurities left from the previous use with a rag made from non-synthetic textile; failure to do so may damage the teflon surfaces. You may start working with the welding apparatus when it is sufficiently hot, which you can check using the LED diode or a contact thermometer. Use the contact thermometer if you need to fine-tune the temperature up to 250 – 270 °C. Check the proper functionality of the special shears or cutting wheel by making two cuts on a pipe assigned for testing purposes. The trial cutting should not deform or depress the outer diameter of the pipe; if it does, the tools need to be sharpened further.

### Materials check

All the material should be inspected thoroughly prior to welding. The components must not contain any wall thinning defects and closing elements should be checked if they function properly and correspond to their matching piece. Welding sockets and the end of the pipe to be inserted into the fitting should be cleaned and degreased. Test the fittings by sliding them on the heating plug (which of course must remain cold for now) and check if they are not too loose. Wobbly fittings must be discarded!

### Welding process

- 1/ Measure and cut off a piece of pipe of a desirable length. When using a metal hand saw, make sure to clean the burr and dross from the pipe's edge.
- 2/ It is also recommended to bevel the outer edges of the pipe that we mean to heat up. Use of a special cutter or a sharp knife at approximate angle of 30 – 45 degrees. This procedure is strongly recommended especially for pipe diameters over 40 mm. This modification will prevent the material from bunching up when the pipe end is inserted into a fitting.



- 3/ If you are welding components from Pilsa Stabi, make sure to first remove the outer PPR and middle aluminium layers (using special shavers) along the whole section of the pipe to be inserted into the fitting's socket. The cleaned pipe then can be handled in the same way as the all-plastic pipes Pilsa PPR.

- 4/ If you are welding larger diameters (40 mm and more) it is recommended that you check their ovality first. You should also scrape off the oxidized surface layer (about 0,1 mm in depth) along the whole length of the pipe to be inserted. The oxidized material can have negative effect on the weld quality.
- 5/ The insertion depth of the pipe (to be inserted into a pipe fitting) should be marked with a marker or a sharpie. Keep in mind that the pipe must not be pushed into the fitting socket as far as it can possibly go. About a 1mm gap should be preserved for material accumulation so as not to reduce the fitting's intern
- 6/ Furthermore, it is recommended that you also mark the weld position on both the pipe and the fitting, in order to prevent the pipe from rotating after insertion. You can also use installation marks on fittings for the same purpose.



- 7/ The surfaces to be welded should be cleaned and degreased after the marking is complete. If this step is left out, then the melted layers may bond inadequately! Now you can begin the heating-up process.
- 8/ Due to its thicker walls, the fitting needs more time to heat up properly and should be put on the welding adapter first. Check if it is not too loose once again; a fitting that wobbles or does not fit the whole surface of the adapter should be discarded because uneven contact (and subsequent uneven heat up of the material) may result in poor-quality welds. Next slide the pipe onto the adapter and repeat the same procedure as with the fitting.
- 9/ Heat up both components for the time shown in Table 1, page 29. The heating time is measured starting with the moment when both the pipe and the fitting are set on the adapter with their whole marked lengths. If you experience difficulties sliding the components in place, try to rotate them slightly (max. 10 °) until they are fully settled on the adapter. You may not rotate the components once the heating period begins; it could cause material to bunch up in some sections.
- 10/ After the heating period is finished, remove both the fitting and the pipe and couple them together by inserting the pipe into the fitting socket for the whole marked length with gentle and uniform pressure. Again, do not rotate the components. After this is done, check the axis alignment of both components. Table 1 on page 29 shows maximum permissible intervals between the component removal from the adapter and their coupling. Exceeding these intervals will cause the melted layers to cool excessively, thus creating a poor-quality joint due to insufficient fusion of the material.

**The piping system may be filled with water not earlier than one hour after the last weld has been completed.**

**Recommendation for welding operations involving large diameters:** Pipes up to 40 mm in diameter may be welded while holding them in your hand; for the larger diameters (50 mm and more) machine welding or at least a welding jig is recommended in order to ensure sufficient pressure and correct alignment of the pipes.

## I. Preparation of pipes



bevelling



scraping



## II. Welding



fixing and aligning the components, then heating them up



adjustment after the heating period



finished weld after the cool-down

Table: 1

D [mm]	insertion depth L (mm)	heat-up time [s]
16	13	5
20	14	5
25	15	7
32	17	8
40	18	12
50	20	18
63	26	24
75	29	30
90	32	40
110	35	50
125	41	60

Table: 2

D [mm]	time for adjustment [s]	cooling time [min]	
		fixation (s)	total (min)
16, 20	4	6	2
25	4	10	2
32	6	10	4
40, 50	6	20	4
63, 75	8	30	6
90	8	40	6
110	10	50	8
125	10	60	8

#### 14. Welding With Electrofusion Sockets - Working Procedures

##### Tools

- 1/ Electrofusion welding machine for electric welding of plastic pipes (electrofusion socket welder)
- 2/ Special shears or cutter.
- 3/ Textile rag (non-synthetic material only).
- 4/ Degreaser, sharp knife with short blade.
- 5/ Folding ruler + marker
- 6/ Welding jig to secure the pipe and fitting and ensure their correct alignment.
- 7/ Scraper and assembly jig for welding of diameters over 50 mm.
- 8/ Pipe shaver (when welding Pilsa Stabi pipes).

##### Preparing the tools

Place the welding machine at your workplace and unreel the power cable. Check your cutting tools (for details see Chapter 13: Polyfusion Welding).



##### Welding process

Check the pipe and the fitting and prepare the welding machine. Prepare the pipe of required length and remove the oxidized layer with a scraper or special agent. Degrease the external surface of the pipe and internal surface of the electrofusion socket (use alcohol or Tangit).

After you are done, mark the pipe insertion depth (depth of insertion inside the electrofusion socket). If you are working with the Pilsa Stabi piping, then make sure to remove the outer PPR and middle aluminium layers first, using a special shaver along the whole pipe section to be inserted into the socket. Insert the pipe into the electrofusion socket. Make sure the pipe is firmly fixed in the socket because due to the volume expansion of heated plastic material the pipe could be pushed out of its place during the heating process.

Connect the electrofusion welding machine to the power supply (220V) and wait until the welding machine gets into operational state. Then connect the contacts of the electrofusion socket and welding machine. Welding starts after you push the START button; the welding machine switches off automatically after the weld is completed. You can tell the electrofusion welding is proceeding well if the excess plastic material is being squeezed out of the check-points on the socket's surface. The newly coupled piping system may be filled with water not earlier than one hour after the last weld has been completed.

It is very important to let the new joint cool down before exposing it to any strain.

The weld should be also protected from mechanical tension (pipe's rotation or pull).



# Repairing Piping Damage

## 15. Repairing Piping Damage

- ⦿ A unique way of repairing pipes drilled through – should be a part of every plumber's kit.
- ⦿ Considerably reduces the extent of demolition work and damage to tiles.
- ⦿ The set includes a special heating adapter and repairing stakes.
- ⦿ The adapter is universally compatible with all types of non-paired welding machines incl. the angle welding machines.
- ⦿ A special non-paired adapter is now part of the welding set.
- ⦿ The set is intended for repair of drilled through pipelines Pilsa PPR and Pilsa Stabi.
- ⦿ It is a universal fit for all diameters between 20 and 125 mm, as well as for all pressure lines.
- ⦿ It operates on the principle of polyfusion welding and all general rules for polyfusion welding are applicable – see the General Rules for polyfusion welding.

Required tools: repairing set, piece of cloth or napkin for degreasing and drying out, tape measure, pencil, screwdriver, scissors (pliers), special welding adapters, correcting spike and welding machine. Turn on the welding machine with the welding adapter attached, set it to the maximum and wait at least for the second heat-up cycle.



*Repairing set for pipes drilled through*



1. The drilled hole must be re-drilled (calibrated) with a 10 mm drill.



2. Dry and degrease. Measure and mark the depth of insertion on the stake depending on the wall thickness of the drilled through pipe + 2 mm; set the distance ring on the heating adaptor.



3. Start heating the repairing stake and adaptor and insert the heating stake slowly and without turning into the prepared hole. Heat for 5 seconds.



4. Take down the repairing stake and insert without turning into the heated hole.



5. When it cools down, cut off the remaining part of the repairing stake with a pair of shears.

If you have no previous experience with the repair set, we recommend that you test it out with two test welds, cut them and visually check the weld – both the quality of the fusion and the size of melted collars.

# Additional Branching

## 16. Additional Branching

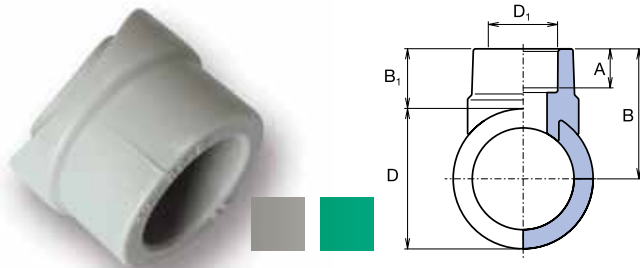

All-plastic weld-in saddle

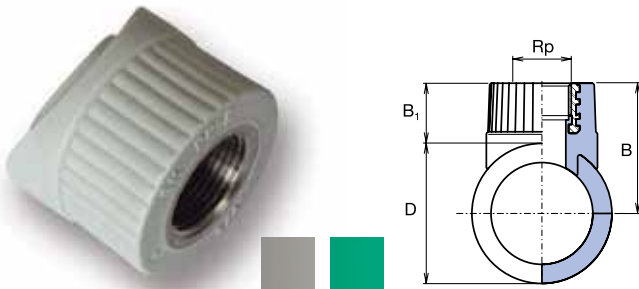

Weld-in saddle with metal thread female

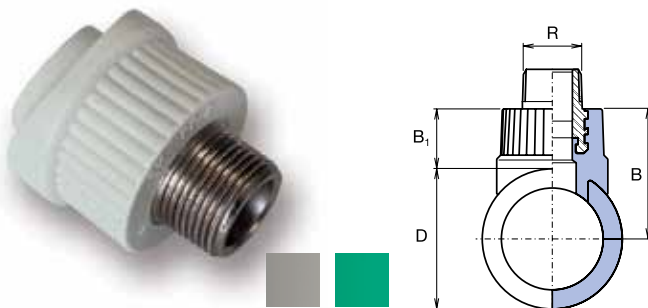

Weld-in saddle with metal thread male

- ⦿ The large assortment of fittings allows to create a 32 or 40 mm diameter branching or branching with both internal and external thread (3/4").
- ⦿ For all Pilsa PPR and Pilsa Stabi pipelines with diameters 63, 75, 90, 110, 125 mm and for all pressure lines.
- ⦿ The principle of polyfusion welding type C is maintained.
- ⦿ Special heating adaptors for each pipeline diameter; universal for all types of flat welding machines.
- ⦿ Saves work and space – replaces the T– pieces and reducers.
- ⦿ Connecting the saddle and the pipe ensures a perfectly connected joint throughout the entire welding area.



**32 mm branching for a 90 mm diameter pipeline**  
 Old method (on the left): T-piece 90 mm, reducer 90/63 mm and reducer 63/32 mm. New method (on the right): welding saddle 90 × 32 mm.



**Useful tools:** special drill, drilling machine, piece of fabric or napkin for degreasing, special heating adaptor for weld in saddle, welding machine, edge-bevelling tool (for Stabi pipes)

	diameter	D mm	D <sub>1</sub> mm	R <sub>p</sub>	R	A mm	B <sub>1</sub> mm	B mm
1	63 × 32	63	32			18	27,0	58,5
	75 × 32	75	32			18	27,0	64,5
	90 × 32	90	32			18	27,0	72,0
	110 × 32	110	32			18	25,7	80,7
2	110 × 40	110	40			21	25,7	80,7
	63 × 3/4"	63		3/4"			27,0	58,5
	75 × 3/4"	75		3/4"			27,0	64,5
3	90 × 3/4"	90		3/4"			27,0	72,0
	63 × 3/4"	63			3/4"		44,8	76,3
	75 × 3/4"	75			3/4"		44,8	82,3
	90 × 3/4"	90			3/4"		44,8	89,8

Dimensions listed in millimeters.





1. Drill a hole into the pipe with the special drill.

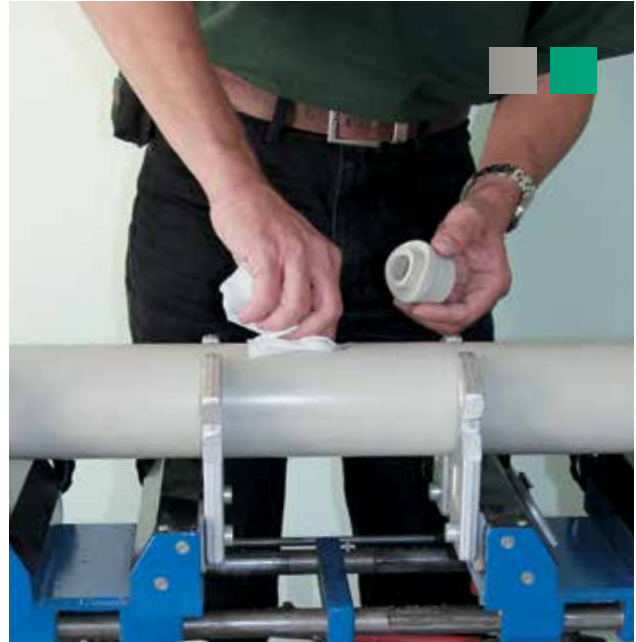

2. Clean. If you use the Stabi pipe, chamfer the edge of the drilled hole. Clean and degrease the weld-in saddle as well as the drilled hole.



3. Put the plastic weld-in saddle on the adapter so that the mark on the saddle and the mark on the adapter are aligned. Heat-up the hole and the plastic weld-in saddle. The heating period is the same as with the 32 mm diameter (8 sec.). For weld-in saddle parts 110 × 32 and 110 × 40 the heating-up period is the same as for the 40 mm ones (12 sec.).



4. Put the heated saddle on the heated hole and fasten for about 16 seconds. You can fill the pipe with water and expose it to pressure one hour later.

# Pressure loss tables

S 5 (PN10) water temperature = 10° C																					
k=0,01	20 x 2,3mm		25 x 2,5mm		32 x 3,0mm		40 x 3,7mm		50 x 4,6mm		63 x 5,8mm		75 x 6,9mm		90 x 8,2mm		110 x 10mm		125 x 11,4mm		
Q l/s	R kPa/m	v m/s	R kPa/m	v m/s	R kPa/m	v m/s	R kPa/m	v m/s	R kPa/m	v m/s	R kPa/m	v m/s	R kPa/m	v m/s	R kPa/m	v m/s	R kPa/m	v m/s	R kPa/m	v m/s	
0,02	0,020	0,1	0,006	0,1																	
0,04	0,067	0,2	0,019	0,1	0,006	0,1															
0,06	0,137	0,3	0,039	0,2	0,011	0,1	0,004	0,1													
0,08	0,227	0,4	0,065	0,3	0,019	0,2	0,006	0,1	0,002	0,1											
0,10	0,337	0,5	0,097	0,3	0,028	0,2	0,009	0,1	0,003	0,1											
0,12	0,465	0,6	0,133	0,4	0,038	0,2	0,013	0,1	0,004	0,1	0,001	0,1									
0,14	0,611	0,8	0,175	0,4	0,050	0,3	0,017	0,2	0,006	0,1	0,002	0,1									
0,16	0,774	0,9	0,222	0,5	0,063	0,3	0,022	0,2	0,007	0,1	0,002	0,1	0,001	0,1							
0,18	0,954	1,0	0,273	0,6	0,078	0,3	0,027	0,2	0,009	0,1	0,003	0,1	0,001	0,1							
0,20	1,150	1,1	0,329	0,6	0,094	0,4	0,032	0,2	0,011	0,2	0,004	0,1	0,002	0,1							
0,30	2,370	1,6	0,674	1,0	0,192	0,6	0,065	0,4	0,022	0,2	0,007	0,1	0,003	0,1	0,001	0,1					
0,40	3,971	2,1	1,124	1,3	0,319	0,8	0,108	0,5	0,037	0,3	0,012	0,2	0,005	0,1	0,002	0,1	0,001	0,1			
0,50	5,939	2,7	1,675	1,6	0,474	0,9	0,160	0,6	0,055	0,4	0,018	0,2	0,008	0,2	0,003	0,1	0,001	0,1			
0,60	8,266	3,2	2,322	1,9	0,655	1,1	0,221	0,7	0,076	0,5	0,025	0,3	0,011	0,2	0,005	0,1	0,002	0,1			
0,70			3,064	2,2	0,863	1,3	0,291	0,8	0,099	0,5	0,033	0,3	0,014	0,2	0,006	0,2	0,002	0,1			
0,80			3,900	2,5	1,095	1,5	0,369	1,0	0,126	0,6	0,042	0,4	0,018	0,3	0,008	0,2	0,003	0,1	0,002	0,1	
0,90			4,826	2,9	1,352	1,7	0,455	1,1	0,155	0,7	0,051	0,4	0,022	0,3	0,009	0,2	0,004	0,1	0,002	0,1	
1,00			5,844	3,2	1,634	1,9	0,549	1,2	0,187	0,8	0,062	0,5	0,027	0,3	0,011	0,2	0,004	0,2	0,002	0,1	
1,20					2,269	2,3	0,760	1,4	0,258	0,9	0,085	0,6	0,037	0,4	0,015	0,3	0,006	0,2	0,003	0,1	
1,40					2,998	2,6	1,001	1,7	0,340	1,1	0,112	0,7	0,049	0,5	0,020	0,3	0,008	0,2	0,004	0,1	
1,60					3,819	3,0	1,273	1,9	0,431	1,2	0,142	0,8	0,062	0,5	0,026	0,4	0,010	0,3	0,005	0,2	
1,80					4,732	3,4	1,574	2,2	0,532	1,4	0,175	0,9	0,076	0,6	0,031	0,4	0,012	0,3	0,006	0,2	
2,00							1,903	2,4	0,642	1,5	0,211	1,0	0,092	0,7	0,038	0,5	0,014	0,3	0,008	0,2	
2,20							2,262	2,6	0,762	1,7	0,250	1,1	0,108	0,7	0,045	0,5	0,017	0,3	0,009	0,3	
2,40							2,649	2,9	0,891	1,8	0,292	1,2	0,126	0,8	0,052	0,6	0,020	0,4	0,010	0,3	
2,60							3,064	3,1	1,029	2,0	0,337	1,3	0,146	0,9	0,060	0,6	0,023	0,4	0,012	0,3	
2,80							3,507	3,4	1,176	2,1	0,385	1,3	0,166	1,0	0,069	0,7	0,026	0,4	0,014	0,3	
3,00									1,332	2,3	0,436	1,4	0,188	1,0	0,078	0,7	0,030	0,5	0,016	0,4	
3,20									1,497	2,4	0,489	1,5	0,211	1,1	0,087	0,8	0,033	0,5	0,018	0,4	
3,40									1,671	2,6	0,545	1,6	0,235	1,2	0,097	0,8	0,037	0,5	0,019	0,4	
3,60									1,854	2,8	0,604	1,7	0,260	1,2	0,107	0,8	0,041	0,6	0,022	0,4	
3,80									2,045	2,9	0,666	1,8	0,287	1,3	0,118	0,9	0,045	0,6	0,024	0,5	
4,00									2,246	3,1	0,731	1,9	0,314	1,4	0,129	0,9	0,049	0,6	0,026	0,5	
4,20									2,454	3,2	0,798	2,0	0,343	1,4	0,141	1,0	0,054	0,7	0,028	0,5	
4,40									2,672	3,4	0,868	2,1	0,373	1,5	0,153	1,0	0,058	0,7	0,031	0,5	
4,60									2,898	3,5	0,940	2,2	0,404	1,6	0,166	1,1	0,063	0,7	0,034	0,6	
4,80											1,016	2,3	0,436	1,6	0,179	1,1	0,068	0,8	0,037	0,6	
5,00											1,093	2,4	0,469	1,7	0,193	1,2	0,073	0,8	0,039	0,6	
5,20											0,492	1,8	0,203	1,2	0,078	0,8	0,041	0,6			
5,40													0,523	1,8	0,218	1,3	0,083	0,9	0,045	0,7	
5,60													0,560	2,0	0,234	1,3	0,088	0,9	0,048	0,7	
5,80													0,598	2,0	0,247	1,4	0,094	0,9	0,051	0,7	
6,00													0,637	2,0	0,264	1,4	0,099	0,9	0,054	0,7	
6,20													0,672	2,1	0,281	1,5	0,105	1,0	0,058	0,8	
6,40													0,714	2,2	0,295	1,5	0,113	1,0	0,061	0,8	
6,60													0,757	2,2	0,313	1,6	0,119	1,0	0,064	0,8	
6,80													0,801	2,3	0,332	1,6	0,125	1,1	0,068	0,8	
7,00													0,831	2,4	0,351	1,7	0,132	1,1	0,071	0,9	
7,50															0,394	1,8	0,150	1,2	0,081	0,9	
8,00															0,445	1,9	0,168	1,3	0,092	1,0	
8,50															0,498	2,0	0,188	1,3	0,102	1,0	
9,00															0,554	2,1	0,206	1,4	0,113	1,1	
9,50															0,607	2,2	0,228	1,5	0,124	1,2	
10,0															0,668	2,4	0,251	1,6	0,136	1,2	
10,5																	0,275	1,7	0,148	1,3	
11,0																	0,299	1,7	0,161	1,3	
11,5																	0,325	1,8	0,175	1,4	
12,0																	0,352	1,9	0,188	1,5	
12,5																	0,376	2,0	0,203	1,5	
13,0																	0,404	2,0	0,218	1,6	
13,5																	0,434	2,1	0,235	1,7	
14,0																	0,464	2,2	0,251	1,7	
15,5																	0,496	2,3	0,268	1,8	
15,0																	0,528	2,4	0,283	1,8	
15,5																			0,302	1,9	
16,0																			0,319	2,0	
16,5																			0,337	2,0	
17,0																			0,356	2,1	
17,5																			0,375	2,1	
18,0																			0,395	2,2	
18,5																			0,418	2,3	
19,0																			0,439	2,3	
19,5																			0,460	2,4	

S 3,2 (PN16) water temperature = 50° C																						
k=0,01	16 × 2,3 mm		20 × 2,8 mm		25 × 3,5 mm		32 × 4,5 mm		40 × 5,6 mm		50 × 6,9 mm		63 × 8,7 mm		75 × 10,4 mm		90 × 12,5 mm		110 × 15,2 mm		125 × 17,1 mm	
Q 1/s	R kPa/m	v m/s	R kPa/m	v m/s	R kPa/m	v m/s	R kPa/m	v m/s	R kPa/m	v m/s	R kPa/m	v m/s	R kPa/m	v m/s	R kPa/m	v m/s	R kPa/m	v m/s	R kPa/m	v m/s	R kPa/m	v m/s
0,02	0,068	0,2	0,022	0,1	0,008	0,1																
0,04	0,230	0,4	0,075	0,2	0,026	0,2	0,008	0,1	0,003	0,1												
0,06	0,473	0,6	0,154	0,4	0,053	0,2	0,016	0,1	0,006	0,1	0,002	0,1										
0,08	0,792	0,8	0,257	0,5	0,088	0,3	0,027	0,2	0,009	0,1	0,003	0,1										
0,10	1,183	1,0	0,382	0,6	0,131	0,4	0,040	0,2	0,014	0,2	0,005	0,1	0,002	0,1								
0,12	1,644	1,2	0,530	0,7	0,181	0,5	0,056	0,3	0,019	0,2	0,006	0,1	0,002	0,1	0,001	0,1						
0,14	2,175	1,4	0,698	0,9	0,238	0,6	0,073	0,3	0,025	0,2	0,008	0,1	0,003	0,1	0,001	0,1						
0,16	2,773	1,6	0,888	1,0	0,302	0,6	0,093	0,4	0,032	0,2	0,011	0,2	0,004	0,1	0,002	0,1						
0,18	3,439	1,8	1,099	1,1	0,373	0,7	0,115	0,4	0,039	0,3	0,013	0,2	0,004	0,1	0,002	0,1	0,001	0,1				
0,20	4,172	2,0	1,330	1,2	0,450	0,8	0,138	0,5	0,047	0,3	0,016	0,2	0,005	0,1	0,002	0,1	0,001	0,1				
0,30	8,828	2,9	2,785	1,8	0,935	1,2	0,285	0,7	0,096	0,5	0,032	0,3	0,011	0,2	0,005	0,1	0,002	0,1	0,001	0,1		
0,40			4,731	2,5	1,578	1,6	0,478	1,0	0,161	0,6	0,054	0,4	0,018	0,2	0,008	0,2	0,003	0,1	0,001	0,1		
0,50			7,161	3,1	2,376	2,0	0,716	1,2	0,240	0,8	0,080	0,5	0,026	0,3	0,012	0,2	0,005	0,2	0,002	0,1		
0,60					3,325	2,4	0,997	1,4	0,334	0,9	0,110	0,6	0,036	0,4	0,016	0,3	0,007	0,2	0,003	0,1		
0,70					4,425	2,8	1,322	1,7	0,441	1,1	0,146	0,7	0,048	0,4	0,021	0,3	0,009	0,2	0,003	0,1		
0,80					5,675	3,1	1,689	1,9	0,562	1,2	0,185	0,8	0,061	0,5	0,026	0,3	0,011	0,2	0,004	0,2	0,002	0,1
0,90					7,073	3,5	2,098	2,2	0,696	1,4	0,229	0,9	0,075	0,6	0,033	0,4	0,014	0,3	0,005	0,2	0,003	0,1
1,00							2,549	2,4	0,843	1,5	0,277	1,0	0,091	0,6	0,039	0,4	0,016	0,3	0,006	0,2	0,003	0,1
1,20							3,577	2,9	1,178	1,8	0,385	1,2	0,126	0,7	0,055	0,5	0,023	0,4	0,009	0,2	0,005	0,2
1,40							4,770	3,4	1,565	2,1	0,510	1,4	0,166	0,9	0,072	0,6	0,030	0,4	0,011	0,3	0,006	0,2
1,60									2,004	2,5	0,650	1,6	0,211	1,0	0,091	0,7	0,038	0,5	0,014	0,3	0,008	0,3
1,80									2,494	2,8	0,807	1,7	0,261	1,1	0,113	0,8	0,047	0,5	0,018	0,4	0,009	0,3
2,00									3,036	3,1	0,980	1,9	0,316	1,2	0,136	0,9	0,057	0,6	0,021	0,4	0,011	0,3
2,20									3,629	3,4	1,168	2,1	0,376	1,3	0,162	1,0	0,067	0,7	0,025	0,4	0,013	0,3
2,40											1,372	2,3	0,441	1,5	0,190	1,0	0,079	0,7	0,030	0,5	0,015	0,4
2,60											1,592	2,5	0,511	1,6	0,220	1,1	0,091	0,8	0,034	0,5	0,018	0,4
2,80											1,828	2,7	0,585	1,7	0,251	1,2	0,104	0,8	0,039	0,6	0,020	0,5
3,00											2,079	2,9	0,664	1,8	0,285	1,3	0,118	0,9	0,044	0,6	0,023	0,5
3,20											2,345	3,1	0,748	2,0	0,320	1,4	0,132	1,0	0,050	0,6	0,025	0,5
3,40											2,627	3,3	0,837	2,1	0,358	1,5	0,148	1,0	0,055	0,7	0,029	0,6
3,60											2,925	3,5	0,930	2,2	0,398	1,6	0,164	1,1	0,061	0,7	0,032	0,6
3,80													1,028	2,3	0,439	1,6	0,181	1,1	0,067	0,8	0,035	0,6
4,00													1,131	2,4	0,483	1,7	0,198	1,2	0,074	0,8	0,039	0,7
4,20													1,239	2,6	0,528	1,8	0,217	1,3	0,081	0,8	0,042	0,7
4,40													1,351	2,7	0,575	1,9	0,236	1,3	0,088	0,9	0,046	0,7
4,60													1,468	2,8	0,624	2,0	0,256	1,4	0,095	0,9	0,050	0,7
4,80													1,589	2,9	0,676	2,1	0,277	1,4	0,103	1,0	0,053	0,8
5,00													1,716	3,1	0,729	2,2	0,298	1,5	0,111	1,0	0,057	0,8
5,20															0,774	2,3	0,318	1,6	0,117	1,0	0,062	0,8
5,40															0,832	2,3	0,341	1,6	0,127	1,1	0,066	0,9
5,60															0,893	2,4	0,365	1,7	0,136	1,1	0,070	0,9
5,80															0,949	2,5	0,389	1,8	0,145	1,2	0,076	0,9
6,00															1,014	2,6	0,414	1,8	0,154	1,2	0,081	0,9
6,20															1,081	2,7	0,440	1,9	0,164	1,3	0,086	1,0
6,40															1,142	2,8	0,467	1,9	0,173	1,3	0,091	1,0
6,60															1,212	2,9	0,494	2,0	0,183	1,3	0,096	1,0
6,80															1,285	3,0	0,522	2,1	0,194	1,4	0,101	1,1
7,00															1,351	3,0	0,551	2,1	0,204	1,4	0,107	1,1

S 2,5 (PN20) water temperature = 10° C																						
k=0,01	16 × 2,7 mm		20 × 3,4 mm		25 × 4,2 mm		32 × 5,4 mm		40 × 6,7 mm		50 × 8,4 mm		63 × 10,5 mm		75 × 12,5 mm		90 × 15,0 mm		110 × 18,4 mm		125 × 20,8 mm	
Q l/s	R kPa/m	v m/s	R kPa/m	v m/s	R kPa/m	v m/s	R kPa/m	v m/s	R kPa/m	v m/s	R kPa/m	v m/s	R kPa/m	v m/s	R kPa/m	v m/s	R kPa/m	v m/s	R kPa/m	v m/s	R kPa/m	v m/s
0,02	0,118	0,2	0,041	0,1	0,014	0,1	0,004	0,1														
0,04	0,399	0,5	0,140	0,3	0,047	0,2	0,015	0,1	0,005	0,1												
0,06	0,816	0,7	0,286	0,4	0,096	0,3	0,030	0,2	0,010	0,1	0,004	0,1										
0,08	1,357	0,9	0,475	0,6	0,159	0,4	0,050	0,2	0,017	0,1	0,006	0,1	0,002	0,1								
0,10	2,017	1,1	0,704	0,7	0,236	0,5	0,073	0,3	0,025	0,2	0,009	0,1	0,003	0,1	0,001	0,1						
0,12	2,791	1,4	0,973	0,9	0,325	0,6	0,101	0,3	0,034	0,2	0,012	0,1	0,004	0,1	0,002	0,1						
0,14	3,676	1,6	1,279	1,0	0,427	0,6	0,133	0,4	0,045	0,3	0,016	0,2	0,005	0,1	0,002	0,1	0,001	0,0				
0,16	4,669	1,8	1,622	1,2	0,540	0,7	0,168	0,5	0,057	0,3	0,020	0,2	0,006	0,1	0,003	0,1	0,001	0,1				
0,18	5,768	2,0	2,000	1,3	0,665	0,8	0,206	0,5	0,070	0,3	0,024	0,2	0,008	0,1	0,003	0,1	0,001	0,1				
0,20	6,971	2,3	2,414	1,5	0,802	0,9	0,249	0,6	0,084	0,4	0,029	0,2	0,010	0,1	0,004	0,1	0,002	0,1				
0,30	14,522	3,4	4,994	2,2	1,650	1,4	0,510	0,8	0,172	0,5	0,060	0,3	0,019	0,2	0,008	0,2	0,004	0,1	0,001	0,1		
0,40			8,397	2,9	2,761	1,8	0,849	1,1	0,286	0,7	0,099	0,5	0,032	0,3	0,014	0,2	0,006	0,1	0,002	0,1		
0,50					4,125	2,3	1,264	1,4	0,425	0,9	0,147	0,6	0,048	0,4	0,021	0,3	0,009	0,2	0,003	0,1		
0,60					5,735	2,8	1,752	1,7	0,587	1,1	0,203	0,7	0,066	0,4	0,029	0,3	0,012	0,2	0,005	0,1		
0,70					7,585	3,2	2,311	2,0	0,773	1,3	0,267	0,8	0,087	0,5	0,038	0,4	0,016	0,2	0,006	0,2		
0,80							2,939	2,3	0,981	1,4	0,338	0,9	0,110	0,6	0,048	0,4	0,020	0,3	0,008	0,2	0,004	0,2
0,90							3,635	2,5	1,211	1,6	0,417	1,0	0,135	0,6	0,059	0,5	0,025	0,3	0,010	0,2	0,005	0,2
1,00							4,399	2,8	1,463	1,8	0,503	1,2	0,163	0,7	0,071	0,5	0,030	0,4	0,011	0,2	0,006	0,2
1,20							6,127	3,4	2,031	2,2	0,696	1,4	0,225	0,9	0,097	0,6	0,041	0,4	0,016	0,3	0,008	0,2
1,40									2,683	2,5	0,917	1,6	0,296	1,0	0,128	0,7	0,054	0,5	0,021	0,3	0,011	0,3
1,60									3,417	2,9	1,165	1,8	0,375	1,2	0,162	0,8	0,068	0,6	0,026	0,4	0,013	0,3
1,80									4,233	3,2	1,441	2,1	0,463	1,3	0,200	0,9	0,083	0,6	0,032	0,4	0,017	0,3
2,00											1,742	2,3	0,559	1,4	0,241	1,0	0,101	0,7	0,039	0,5	0,021	0,4
2,20											2,070	2,5	0,663	1,6	0,286	1,1	0,119	0,8	0,046	0,5	0,024	0,4
2,40											2,423	2,8	0,775	1,7	0,334	1,2	0,139	0,8	0,054	0,6	0,028	0,4
2,60											2,803	3,0	0,894	1,9	0,385	1,3	0,160	0,9	0,062	0,6	0,033	0,5
2,80											3,208	3,2	1,022	2,0	0,440	1,4	0,183	1,0	0,070	0,7	0,037	0,5
3,00											3,638	3,5	1,158	2,2	0,498	1,5	0,207	1,1	0,080	0,7	0,042	0,6
3,20													1,301	2,3	0,559	1,6	0,232	1,1	0,089	0,8	0,047	0,6
3,40													1,452	2,5	0,623	1,7	0,259	1,2	0,099	0,8	0,052	0,6
3,60													1,610	2,6	0,691	1,8	0,286	1,3	0,110	0,9	0,058	0,7
3,80													1,776	2,7	0,761	1,9	0,316	1,3	0,121	0,9	0,064	0,7
4,00													1,949	2,9	0,835	2,0	0,346	1,4	0,133	1,0	0,069	0,7
4,20													2,131	3,0	0,912	2,1	0,377	1,5	0,145	1,0	0,076	0,8
4,40													2,319	3,2	0,992	2,2	0,410	1,6	0,157	1,0	0,083	0,8
4,60													2,515	3,3	1,075	2,3	0,444	1,6	0,170	1,1	0,089	0,8
4,80													2,718	3,5	1,161	2,4	0,480	1,7	0,184	1,1	0,097	0,9
5,00															1,251	2,5	0,516	1,8	0,198	1,2	0,105	0,9
5,20															1,332	2,7	0,548	1,8	0,207	1,2	0,111	1,0
5,40															1,426	2,8	0,587	1,9	0,222	1,3	0,120	1,0
5,60															1,522	2,9	0,626	2,0	0,235	1,3	0,128	1,0
5,80															1,622	3,0	0,667	2,1	0,251	1,4	0,135	1,1
6,00															1,735	3,1	0,710	2,1	0,268	1,4	0,145	1,1
6,20																	0,753	2,2	0,285	1,5	0,152	1,1
6,40																	0,797	2,3	0,300	1,5	0,162	1,2
6,60																	0,843	2,3	0,318	1,6	0,172	1,2
6,80																	0,897	2,4	0,336	1,6	0,179	1,2
7,00																	0,945	2,5	0,352	1,7	0,190	1,3

S 2,5 (PN20) water temperature = 50° C																						
k=0,01	16 × 2,7 mm		20 × 3,4 mm		25 × 4,2 mm		32 × 5,4 mm		40 × 6,7 mm		50 × 8,4 mm		63 × 10,5 mm		75 × 12,5 mm		90 × 15,0 mm		110 × 18,4 mm		125 × 20,8 mm	
Q l/s	R kPa/m	v m/s	R kPa/m	v m/s	R kPa/m	v m/s	R kPa/m	v m/s	R kPa/m	v m/s	R kPa/m	v m/s	R kPa/m	v m/s	R kPa/m	v m/s	R kPa/m	v m/s	R kPa/m	v m/s	R kPa/m	v m/s
0,02	0,096	0,2	0,034	0,1	0,011	0,1	0,004	0,1														
0,04	0,326	0,5	0,114	0,3	0,038	0,2	0,012	0,1	0,004	0,1												
0,06	0,672	0,7	0,234	0,4	0,078	0,3	0,024	0,2	0,008	0,1	0,003	0,1										
0,08	1,126	0,9	0,390	0,6	0,130	0,4	0,040	0,2	0,014	0,1	0,005	0,1	0,002	0,1								
0,10	1,684	1,1	0,582	0,7	0,193	0,5	0,060	0,3	0,020	0,2	0,007	0,1	0,002	0,1	0,001	0,1						
0,12	2,344	1,4	0,807	0,9	0,267	0,6	0,082	0,3	0,028	0,2	0,010	0,1	0,003	0,1	0,001	0,1						
0,14	3,104	1,6	1,065	1,0	0,351	0,6	0,108	0,4	0,037	0,3	0,013	0,2	0,004	0,1	0,002	0,1	0,001	0,0				
0,16	3,962	1,8	1,356	1,2	0,446	0,7	0,137	0,5	0,046	0,3	0,016	0,2	0,005	0,1	0,002	0,1	0,001	0,1				
0,18	4,918	2,0	1,679	1,3	0,551	0,8	0,169	0,5	0,057	0,3	0,020	0,2	0,006	0,1	0,003	0,1	0,001	0,1				
0,20	5,972	2,3	2,033	1,5	0,666	0,9	0,204	0,6	0,069	0,4	0,024	0,2	0,008	0,1	0,003	0,1	0,001	0,1				
0,30	12,680	3,4	4,273	2,2	1,388	1,4	0,423	0,8	0,141	0,5	0,049	0,3	0,016	0,2	0,007	0,2	0,003	0,1	0,001	0,1		
0,40			7,281	2,9	2,348	1,8	0,710	1,1	0,236	0,7	0,081	0,5	0,026	0,3	0,011	0,2	0,005	0,1	0,002	0,1		
0,50					3,541	2,3	1,065	1,4	0,353	0,9	0,121	0,6	0,039	0,4	0,017	0,3	0,007	0,2	0,003	0,1		
0,60					4,964	2,8	1,486	1,7	0,491	1,1	0,168	0,7	0,054	0,4	0,023	0,3	0,010	0,2	0,004	0,1		
0,70					6,616	3,2	1,972	2,0	0,649	1,3	0,221	0,8	0,071	0,5	0,031	0,4	0,013	0,2	0,005	0,2		
0,80							2,523	2,3	0,828	1,4	0,281	0,9	0,090	0,6	0,039	0,4	0,016	0,3	0,006	0,2	0,003	0,2
0,90							3,138	2,5	1,027	1,6	0,348	1,0	0,111	0,6	0,048	0,5	0,020	0,3	0,008	0,2	0,004	0,2
1,00							3,816	2,8	1,245	1,8	0,421	1,2	0,135	0,7	0,058	0,5	0,024	0,4	0,009	0,2	0,005	0,2
1,20							5,364	3,4	1,742	2,2	0,587	1,4	0,187	0,9	0,080	0,6	0,033	0,4	0,013	0,3	0,007	0,2
1,40									2,317	2,5	0,778	1,6	0,247	1,0	0,106	0,7	0,044	0,5	0,017	0,3	0,009	0,3
1,60									2,971	2,9	0,994	1,8	0,315	1,2	0,135	0,8	0,056	0,6	0,021	0,4	0,011	0,3
1,80									3,702	3,2	1,235	2,1	0,390	1,3	0,167	0,9	0,069	0,6	0,026	0,4	0,014	0,3
2,00											1,501	2,3	0,473	1,4	0,202	1,0	0,083	0,7	0,032	0,5	0,017	0,4
2,20											1,791	2,5	0,563	1,6	0,240	1,1	0,099	0,8	0,038	0,5	0,019	0,4
2,40											2,106	2,8	0,660	1,7	0,281	1,2	0,116	0,8	0,044	0,6	0,023	0,4
2,60											2,445	3,0	0,765	1,9	0,325	1,3	0,134	0,9	0,051	0,6	0,027	0,5
2,80											2,809	3,2	0,877	2,0	0,373	1,4	0,153	1,0	0,058	0,7	0,030	0,5
3,00											3,197	3,5	0,996	2,2	0,423	1,5	0,174	1,1	0,066	0,7	0,035	0,6
3,20													1,123	2,3	0,476	1,6	0,195	1,1	0,074	0,8	0,039	0,6
3,40													1,256	2,5	0,532	1,7	0,218	1,2	0,083	0,8	0,043	0,6
3,60													1,397	2,6	0,591	1,8	0,242	1,3	0,092	0,9	0,048	0,7
3,80													1,545	2,7	0,653	1,9	0,267	1,3	0,101	0,9	0,054	0,7
4,00													1,701	2,9	0,718	2,0	0,293	1,4	0,111	1,0	0,058	0,7
4,20													1,863	3,0	0,786	2,1	0,321	1,5	0,121	1,0	0,064	0,8
4,40													2,033	3,2	0,856	2,2	0,349	1,6	0,132	1,0	0,070	0,8
4,60													2,210	3,3	0,930	2,3	0,379	1,6	0,143	1,1	0,075	0,8
4,80													2,394	3,5	1,006	2,4	0,410	1,7	0,155	1,1	0,081	0,9
5,00															1,086	2,5	0,442	1,8	0,167	1,2	0,088	0,9
5,20															1,158	2,7	0,470	1,8	0,175	1,2	0,093	1,0
5,40															1,242	2,8	0,504	1,9	0,188	1,3	0,101	1,0
5,60															1,327	2,8	0,539	2,0	0,199	1,3	0,108	1,0
5,80															1,416	2,9	0,575	2,1	0,214	1,4	0,114	1,1
6,00															1,517	3,1	0,612	2,1	0,228	1,4	0,122	1,1
6,20																	0,651	2,2	0,243	1,5	0,128	1,1
6,40																	0,690	2,3	0,256	1,5	0,137	1,2
6,60																	0,730	2,3	0,272	1,6	0,146	1,2
6,80																	0,778	2,4	0,288	1,6	0,152	1,2
7,00																	0,821	2,5	0,301	1,7	0,162	1,3

S 2,5 (PN20) water temperature = 80° C																						
k=0,01	16 × 2,7 mm		20 × 3,4 mm		25 × 4,2 mm		32 × 5,4 mm		40 × 6,7 mm		50 × 8,4 mm		63 × 10,5 mm		75 × 12,5 mm		90 × 15,0 mm		110 × 18,4 mm		125 × 20,8 mm	
Q l/s	R kPa/m	v m/s	R kPa/m	v m/s	R kPa/m	v m/s	R kPa/m	v m/s	R kPa/m	v m/s	R kPa/m	v m/s	R kPa/m	v m/s	R kPa/m	v m/s	R kPa/m	v m/s	R kPa/m	v m/s	R kPa/m	v m/s
0,02	0,087	0,2	0,030	1,1	0,010	0,1	0,003	0,1														
0,04	0,299	0,5	0,104	0,3	0,035	0,2	0,011	0,1	0,004	0,1												
0,06	0,619	0,7	0,214	0,4	0,071	0,3	0,022	0,2	0,007	0,1	0,003	0,1										
0,08	1,042	0,9	0,359	0,6	0,119	0,4	0,037	0,2	0,012	0,1	0,004	0,1	0,001	0,1								
0,10	1,565	1,1	0,536	0,7	0,177	0,5	0,054	0,3	0,018	0,2	0,006	0,1	0,002	0,1	0,001	0,1						
0,12	2,186	1,4	0,746	0,9	0,245	0,6	0,075	0,3	0,025	0,2	0,009	0,1	0,003	0,1	0,001	0,1						
0,14	2,905	1,6	0,988	1,0	0,323	0,6	0,099	0,4	0,033	0,3	0,012	0,2	0,004	0,1	0,002	0,1	0,001	0,0				
0,16	3,719	1,8	1,261	1,2	0,412	0,7	0,126	0,5	0,042	0,3	0,015	0,2	0,005	0,1	0,002	0,1	0,001	0,1				
0,18	4,630	2,0	1,565	1,3	0,510	0,8	0,155	0,5	0,052	0,3	0,018	0,2	0,006	0,1	0,003	0,1	0,001	0,1				
0,20	5,636	2,3	1,900	1,5	0,617	0,9	0,188	0,6	0,063	0,4	0,022	0,2	0,007	0,1	0,003	0,1	0,001	0,1				
0,30	12,090	3,4	4,031	2,2	1,296	1,4	0,391	0,8	0,130	0,5	0,045	0,3	0,014	0,2	0,006	0,2	0,003	0,1	0,001	0,1		
0,40			6,918	2,9	2,206	1,8	0,661	1,1	0,218	0,7	0,075	0,5	0,024	0,3	0,010	0,2	0,004	0,1	0,002	0,1		
0,50					3,346	2,3	0,995	1,4	0,327	0,9	0,111	0,6	0,036	0,4	0,015	0,3	0,006	0,2	0,002	0,1		
0,60					4,712	2,8	1,395	1,7	0,456	1,1	0,155	0,7	0,050	0,4	0,021	0,3	0,009	0,2	0,003	0,1		
0,70					6,304	3,2	1,858	2,0	0,605	1,3	0,205	0,8	0,065	0,5	0,028	0,4	0,012	0,2	0,005	0,2		
0,80							2,384	2,3	0,774	1,4	0,261	0,9	0,083	0,6	0,036	0,4	0,015	0,3	0,006	0,2	0,003	0,2
0,90							2,974	2,5	0,963	1,6	0,324	1,0	0,103	0,6	0,044	0,5	0,018	0,3	0,007	0,2	0,003	0,2
1,00							3,626	2,8	1,171	1,8	0,392	1,2	0,124	0,7	0,053	0,5	0,022	0,4	0,009	0,2	0,004	0,2
1,20							5,121	3,4	1,645	2,2	0,549	1,4	0,173	0,9	0,074	0,6	0,031	0,4	0,012	0,3	0,006	0,2
1,40									2,197	2,5	0,730	1,6	0,230	1,0	0,098	0,7	0,040	0,5	0,016	0,3	0,008	0,3
1,60									2,826	2,9	0,936	1,8	0,293	1,2	0,125	0,8	0,051	0,6	0,020	0,4	0,010	0,3
1,80									3,532	3,2	1,166	2,1	0,364	1,3	0,155	0,9	0,064	0,6	0,024	0,4	0,012	0,3
2,00											1,421	2,3	0,443	1,4	0,188	1,0	0,077	0,7	0,029	0,5	0,015	0,4
2,20											1,700	2,5	0,528	1,6	0,224	1,1	0,092	0,8	0,035	0,5	0,018	0,4
2,40											2,003	2,8	0,621	1,7	0,263	1,2	0,107	0,8	0,041	0,6	0,021	0,4
2,60											2,331	3,0	0,721	1,9	0,304	1,3	0,124	0,9	0,047	0,6	0,024	0,5
2,80											2,682	3,2	0,828	2,0	0,349	1,4	0,142	1,0	0,054	0,7	0,027	0,5
3,00											3,058	3,5	0,942	2,2	0,397	1,5	0,162	1,1	0,061	0,7	0,031	0,6
3,20													1,064	2,3	0,447	1,6	0,182	1,1	0,069	0,8	0,036	0,6
3,40													1,192	2,5	0,501	1,7	0,204	1,2	0,077	0,8	0,039	0,6
3,60													1,328	2,6	0,557	1,8	0,226	1,3	0,085	0,9	0,044	0,7
3,80													1,471	2,7	0,616	1,9	0,250	1,3	0,094	0,9	0,049	0,7
4,00													1,621	2,9	0,679	2,0	0,275	1,4	0,103	1,0	0,053	0,7
4,20													1,778	3,0	0,744	2,1	0,301	1,5	0,113	1,0	0,058	0,8
4,40													1,942	3,2	0,812	2,2	0,328	1,6	0,123	1,0	0,064	0,8
4,60													2,113	3,3	0,882	2,3	0,356	1,6	0,134	1,1	0,068	0,8
4,80													2,292	3,5	0,956	2,4	0,386	1,7	0,145	1,1	0,074	0,9
5,00															1,033	2,5	0,416	1,8	0,156	1,2	0,081	0,9
5,20															1,081	2,7	0,436	1,8	0,161	1,2	0,085	1,0
5,40															1,160	2,8	0,467	1,9	0,173	1,3	0,092	1,0
5,60															1,242	2,9	0,500	2,0	0,184	1,3	0,099	1,0
5,80															1,326	3,0	0,534	2,1	0,199	1,4	0,105	1,1
6,00															1,422	3,1	0,569	2,1	0,210	1,4	0,112	1,1
6,20																	0,605	2,2	0,224	1,5	0,118	1,1
6,40																	0,642	2,3	0,236	1,5	0,126	1,2
6,60																	0,680	2,3	0,251	1,6	0,134	1,2
6,80																	0,725	2,4	0,266	1,6	0,140	1,2
7,00																	0,765	2,5	0,279	1,7	0,149	1,3



S 2,5 (PN20) water temperature = 80° C																						
k=0,01	16 × 2,7 mm		20 × 3,4 mm		25 × 4,2 mm		32 × 5,4 mm		40 × 6,7 mm		50 × 8,4 mm		63 × 10,5 mm		75 × 12,5 mm		90 × 15,0 mm		110 × 18,4 mm		125 × 20,8 mm	
Q l/s	R kPa/m	v m/s	R kPa/m	v m/s	R kPa/m	v m/s	R kPa/m	v m/s	R kPa/m	v m/s	R kPa/m	v m/s	R kPa/m	v m/s	R kPa/m	v m/s	R kPa/m	v m/s	R kPa/m	v m/s	R kPa/m	v m/s
0,02	0,087	0,2	0,030	1,1	0,010	0,1	0,003	0,1														
0,04	0,299	0,5	0,104	0,3	0,035	0,2	0,011	0,1	0,004	0,1												
0,06	0,619	0,7	0,214	0,4	0,071	0,3	0,022	0,2	0,007	0,1	0,003	0,1										
0,08	1,042	0,9	0,359	0,6	0,119	0,4	0,037	0,2	0,012	0,1	0,004	0,1	0,001	0,1								
0,10	1,565	1,1	0,536	0,7	0,177	0,5	0,054	0,3	0,018	0,2	0,006	0,1	0,002	0,1	0,001	0,1						
0,12	2,186	1,4	0,746	0,9	0,245	0,6	0,075	0,3	0,025	0,2	0,009	0,1	0,003	0,1	0,001	0,1						
0,14	2,905	1,6	0,988	1,0	0,323	0,6	0,099	0,4	0,033	0,3	0,012	0,2	0,004	0,1	0,002	0,1	0,001	0,0				
0,16	3,719	1,8	1,261	1,2	0,412	0,7	0,126	0,5	0,042	0,3	0,015	0,2	0,005	0,1	0,002	0,1	0,001	0,1				
0,18	4,630	2,0	1,565	1,3	0,510	0,8	0,155	0,5	0,052	0,3	0,018	0,2	0,006	0,1	0,003	0,1	0,001	0,1				
0,20	5,636	2,3	1,900	1,5	0,617	0,9	0,188	0,6	0,063	0,4	0,022	0,2	0,007	0,1	0,003	0,1	0,001	0,1				
0,30	12,090	3,4	4,031	2,2	1,296	1,4	0,391	0,8	0,130	0,5	0,045	0,3	0,014	0,2	0,006	0,2	0,003	0,1	0,001	0,1		
0,40			6,918	2,9	2,206	1,8	0,661	1,1	0,218	0,7	0,075	0,5	0,024	0,3	0,010	0,2	0,004	0,1	0,002	0,1		
0,50					3,346	2,3	0,995	1,4	0,327	0,9	0,111	0,6	0,036	0,4	0,015	0,3	0,006	0,2	0,002	0,1		
0,60					4,712	2,8	1,395	1,7	0,456	1,1	0,155	0,7	0,050	0,4	0,021	0,3	0,009	0,2	0,003	0,1		
0,70					6,304	3,2	1,858	2,0	0,605	1,3	0,205	0,8	0,065	0,5	0,028	0,4	0,012	0,2	0,005	0,2		
0,80							2,384	2,3	0,774	1,4	0,261	0,9	0,083	0,6	0,036	0,4	0,015	0,3	0,006	0,2	0,003	0,2
0,90							2,974	2,5	0,963	1,6	0,324	1,0	0,103	0,6	0,044	0,5	0,018	0,3	0,007	0,2	0,003	0,2
1,00							3,626	2,8	1,171	1,8	0,392	1,2	0,124	0,7	0,053	0,5	0,022	0,4	0,009	0,2	0,004	0,2
1,20							5,121	3,4	1,645	2,2	0,549	1,4	0,173	0,9	0,074	0,6	0,031	0,4	0,012	0,3	0,006	0,2
1,40									2,197	2,5	0,730	1,6	0,230	1,0	0,098	0,7	0,040	0,5	0,016	0,3	0,008	0,3
1,60									2,826	2,9	0,936	1,8	0,293	1,2	0,125	0,8	0,051	0,6	0,020	0,4	0,010	0,3
1,80									3,532	3,2	1,166	2,1	0,364	1,3	0,155	0,9	0,064	0,6	0,024	0,4	0,012	0,3
2,00											1,421	2,3	0,443	1,4	0,188	1,0	0,077	0,7	0,029	0,5	0,015	0,4
2,20											1,700	2,5	0,528	1,6	0,224	1,1	0,092	0,8	0,035	0,5	0,018	0,4
2,40											2,003	2,8	0,621	1,7	0,263	1,2	0,107	0,8	0,041	0,6	0,021	0,4
2,60											2,331	3,0	0,721	1,9	0,304	1,3	0,124	0,9	0,047	0,6	0,024	0,5
2,80											2,682	3,2	0,828	2,0	0,349	1,4	0,142	1,0	0,054	0,7	0,027	0,5
3,00											3,058	3,5	0,942	2,2	0,397	1,5	0,162	1,1	0,061	0,7	0,031	0,6
3,20													1,064	2,3	0,447	1,6	0,182	1,1	0,069	0,8	0,036	0,6
3,40													1,192	2,5	0,501	1,7	0,204	1,2	0,077	0,8	0,039	0,6
3,60													1,328	2,6	0,557	1,8	0,226	1,3	0,085	0,9	0,044	0,7
3,80													1,471	2,7	0,616	1,9	0,250	1,3	0,094	0,9	0,049	0,7
4,00													1,621	2,9	0,679	2,0	0,275	1,4	0,103	1,0	0,053	0,7
4,20													1,778	3,0	0,744	2,1	0,301	1,5	0,113	1,0	0,058	0,8
4,40													1,942	3,2	0,812	2,2	0,328	1,6	0,123	1,0	0,064	0,8
4,60													2,113	3,3	0,882	2,3	0,356	1,6	0,134	1,1	0,068	0,8
4,80													2,292	3,5	0,956	2,4	0,386	1,7	0,145	1,1	0,074	0,9
5,00															1,033	2,5	0,416	1,8	0,156	1,2	0,081	0,9
5,20															1,081	2,7	0,436	1,8	0,161	1,2	0,085	1,0
5,40															1,160	2,8	0,467	1,9	0,173	1,3	0,092	1,0
5,60															1,242	2,9	0,500	2,0	0,184	1,3	0,099	1,0
5,80															1,326	3,0	0,534	2,1	0,199	1,4	0,105	1,1
6,00															1,422	3,1	0,569	2,1	0,210	1,4	0,112	1,1
6,20																	0,605	2,2	0,224	1,5	0,118	1,1
6,40																	0,642	2,3	0,236	1,5	0,126	1,2
6,60																	0,680	2,3	0,251	1,6	0,134	1,2
6,80																	0,725	2,4	0,266	1,6	0,140	1,2
7,00																	0,765	2,5	0,279	1,7	0,149	1,3







Pilsa

CONNECT TO BETTER

S4, S3,2 water temperature = 80° C BASALTTHERM , ALUMINIUM FOILED, COMPOSITE PIPE

Table with columns for pipe diameter (16x2.3mm to 125x14.0mm) and flow rate (Q l/s). Each diameter column contains pairs of resistance (R kPa/m) and velocity (v m/s) values for flow rates from 0.02 to 22.0 l/s.









S3,2, S4 water temperature = 10°C Pilsa Plus																								
k=0,01	16 x 2,2 mm		20 x 2,3 mm		25 x 2,8 mm		32 x 3,6 mm		40 x 4,5 mm		50 x 5,6 mm		63 x 7,1 mm		75 x 8,4 mm		90 x 10,1 mm		110 x 12,3 mm		125 x 14 mm			
Q l/s	R kPa/m	v m/s	R kPa/m	v m/s	R kPa/m	v m/s	R kPa/m	v m/s	R kPa/m	v m/s	R kPa/m	v m/s	R kPa/m	v m/s	R kPa/m	v m/s	R kPa/m	v m/s	R kPa/m	v m/s	R kPa/m	v m/s		
0,02	0,068	0,2	0,020	0,1																				
0,04	0,230	0,4	0,067	0,2	0,016	0,1	0,006	0,1																
0,06	0,473	0,6	0,137	0,3	0,033	0,2	0,008	0,1	0,004	0,1														
0,08	0,792	0,8	0,227	0,4	0,076	0,3	0,019	0,2	0,006	0,1														
0,10	1,306	1,0	0,337	0,5	0,113	0,3	0,036	0,2	0,009	0,1	0,002	0,1												
0,20	4,420	1,9	1,150	1,1	0,377	0,7	0,114	0,4	0,039	0,3	0,014	0,2	0,005	0,1	0,002	0,1								
0,30	9,208	2,8	2,370	1,6	0,757	1,0	0,235	0,6	0,082	0,4	0,027	0,3	0,009	0,2	0,004	0,1								
0,40			3,971	2,1	1,268	1,4	0,393	0,8	0,134	0,5	0,047	0,3	0,015	0,2	0,010	0,2	0,003	0,1						
0,50			5,939	2,7	1,895	1,7	0,586	1,0	0,198	0,7	0,067	0,4	0,023	0,3	0,014	0,2	0,004	0,1						
0,60			8,266	3,2	2,636	2,0	0,801	1,2	0,272	0,8	0,095	0,5	0,031	0,3	0,017	0,3	0,006	0,2						
0,70					3,487	2,4	1,060	1,5	0,363	0,9	0,122	0,6	0,040	0,4	0,022	0,3	0,007	0,2	0,003	0,1				
0,80					4,448	2,7	1,351	1,7	0,458	1,1	0,157	0,7	0,053	0,4	0,028	0,3	0,010	0,2	0,004	0,1				
0,90					5,484	3,0	1,658	1,9	0,564	1,2	0,192	0,8	0,064	0,5	0,034	0,4	0,012	0,2	0,005	0,2				
1,00					6,657	3,4	2,012	2,1	0,678	1,3	0,234	0,9	0,076	0,5	0,046	0,5	0,014	0,3	0,005	0,2	0,003	0,1		
1,20							2,792	2,5	0,948	1,6	0,318	1,0	0,106	0,6	0,061	0,5	0,019	0,3	0,007	0,2	0,004	0,2		
1,40							3,713	2,9	1,246	1,9	0,420	1,2	0,141	0,8	0,076	0,6	0,026	0,4	0,009	0,2	0,005	0,2		
1,60									1,594	2,1	0,535	1,4	0,180	0,9	0,095	0,7	0,032	0,4	0,012	0,3	0,007	0,2		
1,80									1,967	2,4	0,662	1,5	0,219	1,0	0,113	0,8	0,039	0,5	0,015	0,3	0,008	0,2		
2,00									2,392	2,7	0,802	1,7	0,266	1,1	0,136	0,8	0,047	0,5	0,018	0,4	0,010	0,3		
2,20									2,838	2,9	0,954	1,9	0,316	1,2	0,157	0,9	0,055	0,6	0,021	0,4	0,012	0,3		
2,40									3,339	3,2	0,118	2,0	0,366	1,3	0,183	1,0	0,066	0,6	0,025	0,4	0,013	0,3		
2,60											1,294	2,2	0,425	1,4	0,207	1,1	0,076	0,7	0,028	0,5	0,016	0,4		
2,80											1,481	2,4	0,488	1,5	0,236	1,1	0,086	0,7	0,033	0,5	0,018	0,4		
3,00											1,681	2,5	0,549	1,6	0,263	1,2	0,097	0,8	0,037	0,5	0,021	0,4		
3,20											1,892	2,7	0,618	1,7	0,295	1,3	0,111	0,8	0,042	0,6	0,022	0,4		
3,40											2,115	2,9	0,692	1,8	0,325	1,4	0,123	0,9	0,046	0,6	0,025	0,5		
3,60													0,763	1,9	0,360	1,4	0,135	0,9	0,052	0,6	0,028	0,5		
3,80													0,844	2,0	0,393	1,5	0,149	1,0	0,056	0,7	0,030	0,5		
4,00													0,929	2,1	0,432	1,6	0,165	1,1	0,062	0,7	0,034	0,5		
4,20													1,018	2,3	0,467	1,7	0,180	1,1	0,067	0,7	0,037	0,6		
4,40													1,102	2,4	0,509	1,7	0,195	1,2	0,074	0,8	0,041	0,6		
4,60													1,198	2,5	0,547	1,8	0,210	1,2	0,079	0,8	0,043	0,6		
4,80													1,297	2,6	0,592	1,9	0,226	1,3	0,086	0,8	0,047	0,7		
5,00													1,391	2,7	0,632	2,0	0,246	1,3	0,092	0,9	0,051	0,7		
5,20													1,498	2,8	0,680	2,0	0,264	1,4	0,100	0,9	0,053	0,7		
5,40													1,609	2,9	0,730	2,1	0,281	1,4	0,106	0,9	0,058	0,7		
5,60													1,712	3,0	0,775	2,2	0,300	1,5	0,114	1,0	0,062	0,8		
5,80															0,828	2,3	0,322	1,5	0,120	1,0	0,065	0,8		
6,00															0,875	2,3	0,342	1,6	0,129	1,1	0,069	0,8		
6,20															0,952	2,4	0,395	1,7	0,147	1,1	0,080	0,9		
6,40															1,154	2,7	0,451	1,8	0,169	1,2	0,092	1,0		
6,60															1,241	2,8	0,512	2,0	0,193	1,3	0,103	1,0		
6,80															1,399	3,0	0,575	2,1	0,217	1,4	0,116	1,1		
7,00															0,642	2,2	0,240	1,5	0,130	1,5	0,130	1,2		
7,50																	0,713	2,4	0,267	1,6	0,145	1,2		
8,00																	0,786	2,5	0,296	1,7	0,160	1,3		
8,50																	0,864	2,6	0,326	1,8	0,174	1,4		
9,00																	0,944	2,7	0,353	1,8	0,191	1,4		
9,50																	1,028	2,9	0,386	1,9	0,208	1,5		
10,0																	1,122	3,0	0,419	2,0	0,226	1,6		
10,5																		0,450	2,1	0,243	1,6			
11,0																		0,486	2,2	0,262	1,7			
11,5																		0,524	2,3	0,282	1,8			
12,0																		0,563	2,4	0,303	1,8			
12,5																		0,598	2,4	0,321	1,9			
13,0																		0,639	2,5	0,342	2,0			
13,5																		0,681	2,6	0,366	2,0			
14,0																		0,725	2,7	0,389	2,1			
15,5																		0,765	2,8	0,414	2,2			
15,0																		0,811	2,9	0,435	2,2			
15,5																		0,858	3,0	0,460	2,3			
16,0																					0,486	2,4		
16,5																					0,513	2,4		
17,0																					0,536	2,5		
17,5																					0,564	2,6		
18,0																					0,593	2,6		
18,5																					0,622	2,7		
19,0																					0,647	2,8		
19,5																					0,678	2,8		
20,0																					0,709	2,9		
20,5																					0,741	3,0		











S4, S5 water temperature = 50°C Pilsa Plus																						
k=0,01	16 x 2,2 mm		20 x 2,3 mm		25 x 2,8 mm		32 x 3,6 mm		40 x 4,5 mm		50 x 5,6 mm		63 x 7,1 mm		75 x 8,4 mm		90 x 10,1 mm		110 x 12,3 mm		125 x 14 mm	
Q l/s	R kPa/m	v m/s	R kPa/m	v m/s	R kPa/m	v m/s	R kPa/m	v m/s	R kPa/m	v m/s	R kPa/m	v m/s	R kPa/m	v m/s	R kPa/m	v m/s	R kPa/m	v m/s	R kPa/m	v m/s	R kPa/m	v m/s
0,02	0,068	0,2	0,013	0,1																		
0,04	0,230	0,4	0,052	0,2	0,019	0,1	0,003	0,1														
0,06	0,473	0,6	0,108	0,3	0,035	0,2	0,009	0,1	0,003	0,1												
0,08	0,792	0,8	0,181	0,4	0,060	0,3	0,015	0,2	0,006	0,1	0,002	0,1										
0,10	1,064	1,0	0,271	0,5	0,089	0,3	0,028	0,2	0,009	0,1	0,003	0,1										
0,20	3,723	1,9	0,925	1,1	0,306	0,7	0,091	0,4	0,031	0,3	0,017	0,2	0,004	0,1	0,002	0,1						
0,30		2,8	1,947	1,6	0,624	1,0	0,191	0,6	0,066	0,4	0,022	0,3	0,007	0,2	0,003	0,1	0,001	0,1				
0,40			3,319	2,2	1,059	1,4	0,323	0,8	0,109	0,5	0,037	0,3	0,012	0,2	0,005	0,2	0,002	0,1				
0,50			4,999	2,7	1,599	1,7	0,486	1,0	0,162	0,7	0,055	0,4	0,019	0,3	0,008	0,2	0,003	0,1				
0,60			7,046	3,2	2,242	2,0	0,669	1,2	0,224	0,8	0,077	0,5	0,025	0,3	0,011	0,2	0,005	0,2				
0,70					2,289	2,4	0,891	1,5	0,301	0,9	0,100	0,6	0,033	0,4	0,014	0,3	0,006	0,2	0,002	0,1		
0,80					3,837	2,7	1,143	1,7	0,382	1,1	0,129	0,7	0,043	0,4	0,018	0,3	0,008	0,2	0,003	0,1		
0,90					4,757	3,0	1,409	1,9	0,471	1,2	0,158	0,8	0,052	0,5	0,023	0,3	0,010	0,2	0,004	0,2		
1,00					5,805	3,4	1,718	2,1	0,570	1,3	0,194	0,9	0,062	0,5	0,028	0,4	0,011	0,3	0,004	0,2	0,002	0,1
1,20							2,404	2,5	0,802	1,6	0,265	1,0	0,088	0,6	0,037	0,5	0,015	0,3	0,006	0,2	0,003	0,2
1,40							3,221	2,9	1,061	1,9	0,352	1,2	0,117	0,8	0,050	0,5	0,021	0,4	0,008	0,2	0,004	0,2
1,60									1,366	2,1	0,451	1,4	0,150	0,9	0,063	0,6	0,026	0,4	0,010	0,3	0,006	0,2
1,80									1,694	2,4	0,561	1,5	0,183	1,0	0,079	0,7	0,032	0,5	0,012	0,3	0,007	0,2
2,00									2,071	2,7	0,682	1,7	0,223	1,1	0,094	0,8	0,039	0,5	0,015	0,4	0,008	0,3
2,20									2,467	2,9	0,815	1,9	0,266	1,2	0,113	0,8	0,046	0,6	0,017	0,4	0,010	0,3
2,40									2,915	3,2	0,958	2,0	0,309	1,3	0,131	0,9	0,055	0,6	0,021	0,4	0,011	0,3
2,60											1,113	2,2	0,360	1,4	0,153	1,0	0,063	0,7	0,023	0,5	0,013	0,4
2,80											0,279	2,4	0,414	1,5	0,174	1,1	0,072	0,7	0,027	0,5	0,015	0,4
3,00											1,455	2,5	0,467	1,6	0,199	1,1	0,081	0,8	0,030	0,5	0,017	0,4
3,20											1,643	2,7	0,528	1,7	0,222	1,2	0,093	0,8	0,035	0,6	0,017	0,4
3,40											1,841	2,9	0,592	1,8	0,250	1,3	0,103	0,9	0,038	0,6	0,021	0,5
3,60													0,654	1,9	0,275	1,4	0,114	0,9	0,043	0,6	0,023	0,5
3,80													0,725	2,0	0,306	1,4	0,125	1,0	0,047	0,7	0,025	0,5
4,00													0,800	2,1	0,334	1,5	0,139	1,1	0,047	0,7	0,027	0,6
4,20													0,878	2,3	0,368	1,6	0,152	1,1	0,056	0,7	0,031	0,6
4,40													0,953	2,4	0,399	1,7	0,164	1,2	0,062	0,8	0,034	0,6
4,60													1,038	2,5	0,435	1,7	0,178	1,2	0,066	0,8	0,036	0,6
4,80													1,126	2,6	0,469	1,8	0,192	1,3	0,073	0,8	0,039	0,7
5,00													1,210	2,7	0,508	1,9	0,209	1,3	0,077	0,9	0,042	0,7
5,20													1,305	2,8	0,544	2,0	0,224	1,4	0,084	0,9	0,045	0,7
5,40													1,403	2,9	0,586	2,0	0,239	1,4	0,089	0,9	0,048	0,7
5,60													1,496	3,0	0,623	2,1	0,255	1,5	0,096	1,0	0,052	0,8
5,80															0,669	2,2	0,275	1,5	0,102	1,0	0,054	0,8
6,00															0,716	2,3	0,292	1,6	0,109	1,1	0,058	0,8
6,20															0,826	2,4	0,338	1,7	0,125	1,1	0,067	0,9
6,40															0,950	2,6	0,388	1,8	0,144	1,2	0,078	1,0
6,60															1,083	2,8	0,441	2,0	0,164	1,3	0,087	1,0
6,80															1,225	3,0	0,497	2,1	0,185	1,4	0,098	1,1
7,00																0,556	2,2	0,205	1,5	0,111	1,2	
7,50																	0,618	2,4	0,229	1,6	0,123	1,2
8,00																	0,684	2,5	0,254	1,7	0,137	1,3
8,50																	0,753	2,6	0,280	1,8	0,149	1,4
9,00																	0,824	2,7	0,304	1,8	0,163	1,4
9,50																	0,900	2,9	0,333	1,9	0,178	1,5
10,0																	0,984	3,0	0,362	2,0	0,194	1,6
10,5																			0,390	2,1	0,208	1,6
11,0																			0,422	2,2	0,225	1,7
11,5																			0,455	2,3	0,243	1,8
12,0																			0,489	2,4	0,261	1,8
12,5																			0,521	2,4	0,277	1,9
13,0																			0,557	2,5	0,297	2,0
13,5																			0,595	2,6	0,317	2,0
14,0																			0,634	2,7	0,337	2,1
15,5																			0,669	2,8	0,359	2,2
15,0																			0,711	2,9	0,378	2,2
15,5																			0,753	3,0	0,400	2,3
16,0																					0,423	2,4
16,5																					0,447	2,4
17,0																					0,468	2,5
17,5																					0,493	2,6
18,0																					0,518	2,6
18,5																					0,544	2,7
19,0																					0,567	2,8
19,5																					0,594	2,8
20,0																					0,622	2,9
20,5																					0,651	3,0

S4, S5 water temperature = 80°C Pilsa Plus																							
k=0,01	16 x 2,2 mm		20 x 2,3 mm		25 x 2,8 mm		32 x 3,6 mm		40 x 4,5 mm		50 x 5,6 mm		63 x7,1 mm		75 x 8,4 mm		90 x 10,1 mm		110 x 12,3 mm		125 x 14 mm		
Q l/s	R kPa/m	v m/s	R kPa/m	v m/s	R kPa/m	v m/s	R kPa/m	v m/s	R kPa/m	v m/s	R kPa/m	v m/s	R kPa/m	v m/s	R kPa/m	v m/s	R kPa/m	v m/s	R kPa/m	v m/s	R kPa/m	v m/s	
0,02	0,055	0,2																					
0,04	0,185	0,4																					
0,06	0,381	0,6					0,003	0,1															
0,08	0,641	0,8					0,006	0,1															
0,10	0,962	1,0	0,242	0,5	0,079	0,3	0,025	0,2	0,008	0,1	0,003	0,1											
0,20	3,428	1,9	0,840	1,1	0,275	0,7	0,081	0,4	0,027	0,3	0,010	0,2	0,003	0,1	0,002	0,1							
0,30	7,376	2,8	1,788	1,6	0,567	1,0	0,172	0,6	0,059	0,4	0,019	0,3	0,007	0,2	0,003	0,1	0,001	0,1					
0,40			3,070	2,2	0,969	1,4	0,292	0,8	0,098	0,5	0,033	0,3	0,011	0,2	0,005	0,2	0,002	0,1					
0,50			4,652	2,7	1,471	1,7	0,442	1,0	0,146	0,7	0,049	0,4	0,017	0,3	0,007	0,2	0,003	0,1					
0,60			6,590	3,2	2,073	2,0	0,612	1,2	0,203	0,8	0,069	0,5	0,023	0,3	0,010	0,2	0,004	0,2					
0,70					2,774	2,4	0,818	1,5	0,274	0,9	0,090	0,6	0,029	0,4	0,013	0,3	0,005	0,2	0,002	0,1			
0,80					3,574	2,7	1,052	1,7	0,348	1,1	0,117	0,7	0,038	0,4	0,016	0,3	0,007	0,2	0,003	0,1			
0,90					4,445	3,0	1,301	1,9	0,431	1,2	0,143	0,8	0,047	0,5	0,020	0,3	0,009	0,2	0,003	0,2			
1,00							1,591	2,1	0,522	1,3	0,176	0,9	0,056	0,5	0,025	0,4	0,010	0,3	0,004	0,2	0,002	0,1	
1,20							2,236	2,5	0,739	1,6	0,242	1,0	0,079	0,6	0,034	0,5	0,014	0,3	0,005	0,2	0,003	0,2	
1,40							3,008	2,9	0,981	1,9	0,323	1,2	0,106	0,8	0,045	0,5	0,019	0,4	0,007	0,2	0,004	0,2	
1,60									1,267	2,1	0,414	1,4	0,136	0,9	0,057	0,6	0,024	0,4	0,009	0,3	0,005	0,2	
1,80									1,576	2,4	0,517	1,5	0,167	1,0	0,071	0,7	0,029	0,5	0,011	0,3	0,006	0,2	
2,00									1,931	2,7	0,630	1,7	0,204	1,1	0,085	0,8	0,035	0,5	0,013	0,4	0,007	0,3	
2,20									2,306	2,9	0,754	1,9	0,244	1,2	0,103	0,8	0,041	0,6	0,016	0,4	0,009	0,3	
2,40									2,73	3,2	0,888	2,0	0,284	1,3	0,119	0,9	0,050	0,6	0,019	0,4	0,010	0,3	
2,60											1,034	2,2	0,331	1,4	0,140	1,0	0,057	0,7	0,021	0,5	0,011	0,4	
2,80											1,190	2,4	0,381	1,5	0,159	1,1	0,065	0,7	0,025	0,5	0,013	0,4	
3,00											1,356	2,5	0,430	1,6	0,182	1,1	0,074	0,8	0,027	0,5	0,015	0,4	
3,20											1,534	2,7	0,487	1,7	0,203	1,2	0,084	0,8	0,031	0,6	0,017	0,4	
3,40											1,721	2,9	0,548	1,8	0,229	1,3	0,094	0,9	0,035	0,6	0,019	0,5	
3,60													0,606	1,9	0,253	1,4	0,104	0,9	0,039	0,6	0,021	0,5	
3,80													0,673	2,0	0,282	1,4	0,114	1,0	0,042	0,7	0,023	0,5	
4,00													0,743	2,1	0,308	1,5	0,127	1,1	0,047	0,7	0,025	0,5	
4,20													0,817	2,3	0,340	1,6	0,139	1,1	0,051	0,7	0,028	0,6	
4,40													0,887	2,4	0,368	1,7	0,151	1,2	0,056	0,8	0,031	0,6	
4,60													0,967	2,5	0,403	1,7	0,163	1,2	0,060	0,8	0,032	0,6	
4,80													1,051	2,6	0,434	1,8	0,176	1,3	0,066	0,8	0,035	0,7	
5,00													1,130	2,7	0,471	1,9	0,192	1,3	0,071	0,9	0,038	0,7	
5,20													1,220	2,8	0,504	2,0	0,206	1,4	0,077	0,9	0,041	0,7	
5,40													1,313	2,9	0,544	2,0	0,221	1,4	0,081	0,9	0,044	0,7	
5,60													1,401	3,0	0,585	2,1	0,235	1,5	0,088	1,0	0,047	0,8	
5,80															0,622	2,2	0,254	1,5	0,093	1,0	0,050	0,8	
6,00															0,666	2,3	0,270	1,6	0,100	1,1	0,053	0,8	
6,50															0,770	2,4	0,313	1,7	0,115	1,1	0,062	0,9	
7,00															0,888	2,6	0,360	1,8	0,132	1,2	0,071	1,0	
7,50															1,013	2,8	0,409	2,0	0,151	1,3	0,080	1,0	
8,00															1,147	3,0	0,462	2,1	0,171	1,4	0,090	1,1	
8,50																0,517	2,2	0,189	1,5	0,102	1,2	1,2	
9,00																0,576	2,4	0,212	1,6	0,113	1,2	1,2	
9,50																0,638	2,5	0,235	1,7	0,126	1,3	1,3	
10,0																0,703	2,6	0,259	1,8	0,137	1,4	1,4	
10,5																0,771	2,7	0,282	1,8	0,151	1,4	1,4	
11,0																0,842	2,9	0,309	1,9	0,165	1,5	1,5	
11,5																0,922	3,0	0,337	2,0	0,180	1,6	1,6	
12,0																	0,362	2,1	0,192	1,6	1,6	1,6	
12,5																	0,393	2,2	0,209	1,7	1,7	1,7	
13,0																	0,424	2,3	0,225	1,8	1,8	1,8	
13,5																	0,456	2,4	0,242	1,8	1,8	1,8	
14,0																	0,486	2,4	0,257	1,9	1,9	1,9	
14,5																	0,520	2,5	0,266	2,0	2,0	2,0	
15,0																	0,556	2,6	0,295	2,0	2,0	2,0	
15,5																	0,593	2,7	0,314	2,1	2,1	2,1	
16,0																	0,627	2,8	0,334	2,2	2,2	2,2	
16,5																	0,666	2,9	0,352	2,2	2,2	2,2	
17,0																	0,706	3,0	0,373	2,3	2,3	2,3	
17,5																				0,395	2,4	2,4	2,4
18,0																					0,417	2,4	2,4
18,5																					0,437	2,5	2,5
19,0																					0,460	2,6	2,6
19,5																					0,484	2,6	2,6
20,0																					0,509	2,7	2,7
20,5																					0,531	2,8	2,8
21,0																					0,557	2,8	2,8
21,5																					0,583	2,9	2,9
22,0																					0,610	3,0	3,0

# Coefficient of Loss \* for System Pilsa PPR Fittings

## 18. Coefficient of Loss \* for System Pilsa PPR Fittings

FITTING			*
		Socket	0,2
		Reducer (by two sizes)	0,55
		Elbow 90 °	1,5
		T-piece – straight flow	1,1

FITTING			*
		T-piece – branching flow	1,5
		T-piece – reduced straight flow	1,1
		T-piece - reduced branching flow	4,3
		Reducing sleeve with metal thread	0,4
		Metal reducer with cap nut	8,3

# References

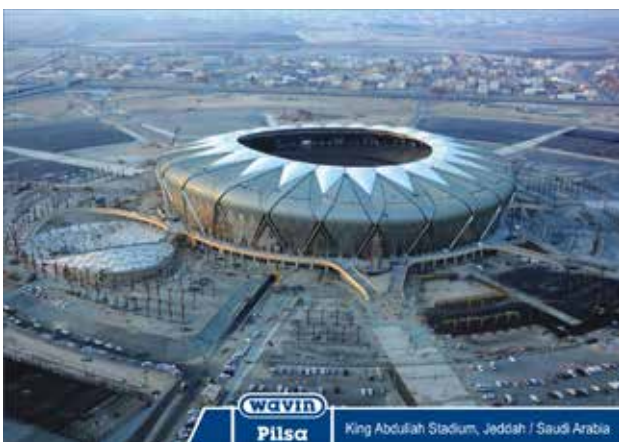



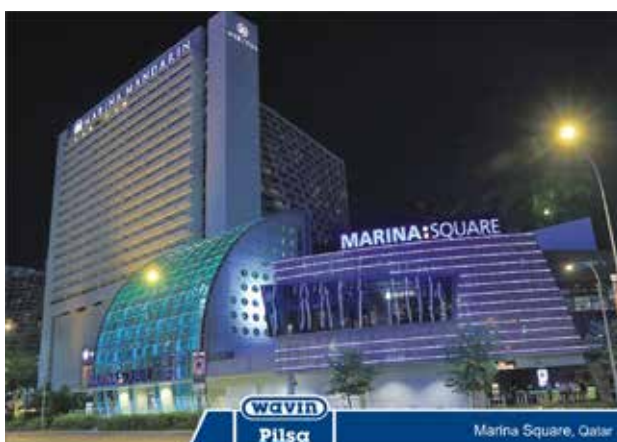

# wavin

## Pilsa

CONNECT TO BETTER



Water management | Heating and cooling | Water and gas distribution  
Waste water drainage | Cable ducting

Wavin operates a programme of continuous product development, and therefore reserves the right to modify or amend the specification of their products without notice. All information in this publication is given in good faith, and believed to be correct at the time of going to press. However, no responsibility can be accepted for any errors, omissions or incorrect assumptions. Users should satisfy themselves that products are suitable for the purpose and application intended.



Wavin TR Plastik Sanayi A.Ş.

info@wavin.com.tr

www.wavin.com.tr • www.wavinacademy.com.tr



# wavin

## Pilsa

CONNECT TO BETTER