

Product, Design & Installation Guide

March 2025

Hepworth
Fired to Perfection

CLAY

Hepworth

Fired to Perfection

CLAY

Contents

Introduction 4

Overview	4
The benefits of Hepworth Clay	6
The lifecycle of Hepworth Clay	8

Products 10

Range Overview	11
Product details – Introduction	16
SuperSleve	
Pipes	17
Couplings	18
Bends	19
Junctions	21
Saddles	23
Taper Pipe	24
Socket Adaptor	24
Traps	24
Gullies	25
Hoppers	29
Stoppers	30
Rodding Points	30
Drain Connectors	31
Adaptors	32
Access Fittings	33
SuperSleve Gratings & Cover Plates	34
Channels	37
Yard Gullies/Road Gullies	46
Unjointed	49
HepLine	51
Accessories	52
Inspection Chambers	53
MAC	54
PPIC	56
Range 450	62
Range 600	68

Design 73

Introduction	74
Design guidance	75
Layout	77
Hydraulic	80
Introduction	80
Design equations	81
Worked examples	82
Pipe flow capacity tables	83
Structural	86
Chemical resistance	91
Product specification	92

Installation 93

Planning, delivery, handling and storage	94
Dismantling a Hepworth Clay pipe pack	95
Pipe laying	96
Trench excavation and formation	96
Bedding requirements	97
Laying pipes in soft ground (TN1)	99
Laying pipes in water-logged ground (TN2)	100
Passing pipes through structures (TN3)	101
Concrete bedding to pipes (TN4)	102
Pipelines under buildings (TN5)	104
Laying pipes at shallow depths (TN6)	105
Laying vitrified clay pipes on recycled material (TN7)	107
HepLine	110
Vertical connections	111
Telescopic Rest Bend	113
Rainwater and waste connections – Gullies	114
Yard Gully	116
Square Top Rodding Point	117

Mini Access Chamber (MAC)	118
Polypropylene Inspection Chambers (PPIC)	120
Range 450 Inspection Chamber	123
Range 600 Inspection Chamber	125
Conventional manhole construction	127
Backdrop connections	128
Pipe connections	129
SuperSleve cutting	130
SuperSleve jointing	132
SuperSleve testing	134
Health and safety, maintenance	136
General information	137

BS 9295:2020 Guide to the structural design of buried pipelines. **New revision** now contains guidance for the use of **recycled aggregates** for pipe bedding.

See pages 107-109 for details.



The finest pipe on Earth, born of the earth.

If you set out today to create the perfect material for drainage, clay would be the product you'd invent.

At Hepworth we have always believed that for future-proof drainage 'clay is the way' – the ultimate sustainable, durable, cost-efficient and high performance sewerage solution.

Clay is a 100% natural and plentiful raw material. Sourced from our local quarries which minimises transportation, the clays are carefully blended to take advantage of their distinct mineralogy prior to heat treatment in a calciner, a globally unique process for clay pipe production.

Filtered moorland rainwater is used to hydrate the clays during pipe extrusion. They are then guided through driers utilizing recovered heat from energy efficient fast firing roller kilns, supporting our environmental policy, leading to BS EN ISO 14001 certification.

Up to 15% of any off-cuts, trimmings or product used in testing are ground down and re-introduced into the manufacturing process with no loss of quality. With total end-of-life recyclability, vitrified clay is the ultimate birth

to rebirth manufacturing process. Even our quarries are expertly returned to flourishing natural habitats, alongside a tree planting programme to continually offset the carbon impact of quarrying activities.

For most construction materials, sustainability is a pipe dream; for Hepworth Clay it's a natural and actual reality.

Clay pipes are inert, making them impervious to almost any chemical or physical attack.

Vitrified Clay's strength not only means it's highly resistant to static and dynamic loadings, it also doesn't need as much granular bedding, cutting installation costs as well as the carbon footprint of aggregate transportation.

It's a genuine fit and forget solution too, that will be trouble-free for future generations. And with no renovation or repairs needed, service costs are as low as its installed risk profile.

To which can be added the Hepworth hallmark of precision manufacturing to guarantee consistent quality, standards compliance, a complementary jointing performance and total service support.

Clay has been used in drainage for more than 6,000 years. For every consulting engineer making a choice today, it is the natural choice for the future.

Hepworth

Fired to Perfection

CLAY

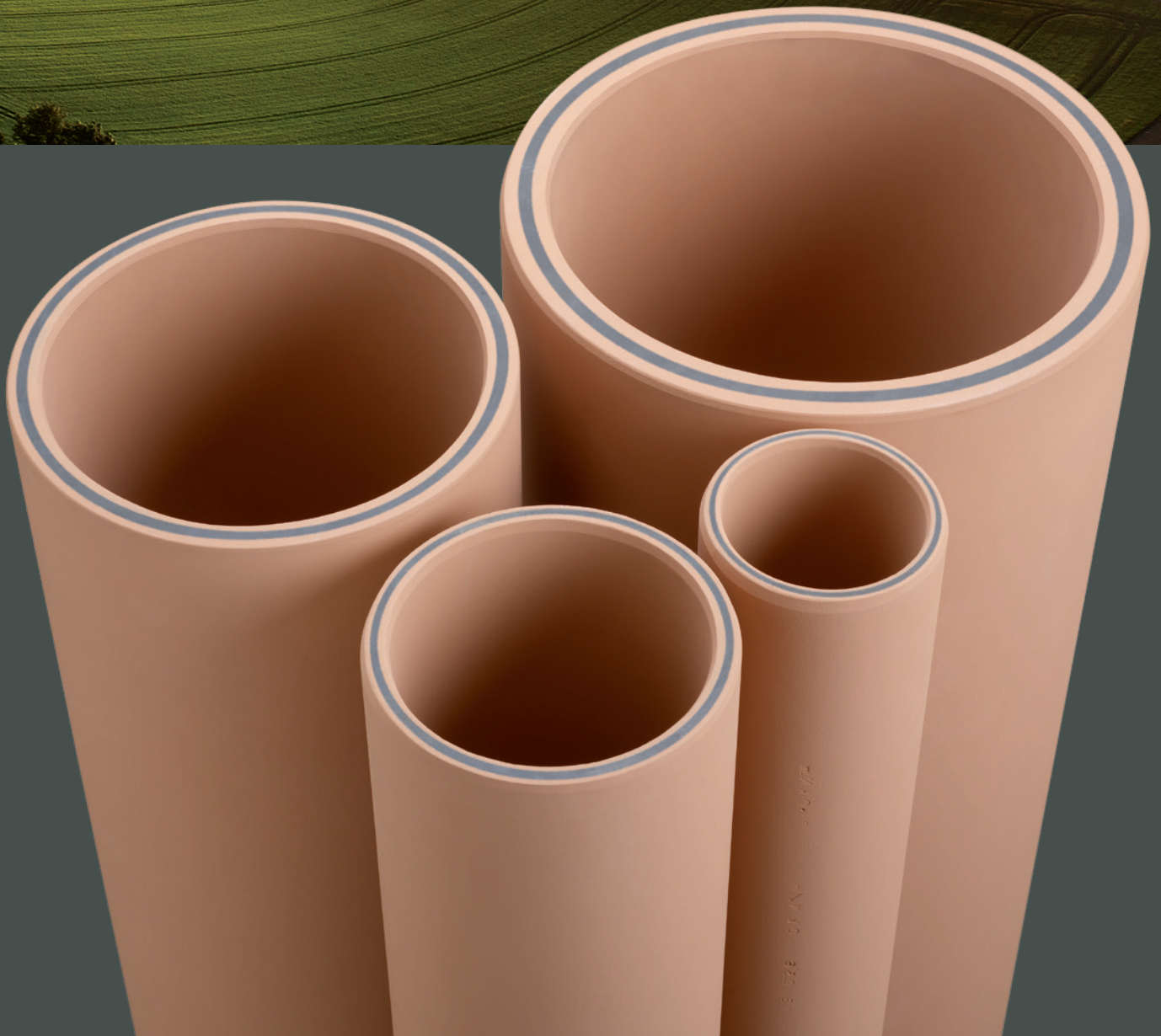

The benefits of Hepworth Clay



Superior strength and durability

High pipe strength is an inherent quality of vitrified clay and is enhanced by our manufacturing expertise. A Hepworth 300mm SuperSleeve pipe has a crushing strength of 72 kN/m.



Superior sustainability

Clay is 100% natural and plentiful raw material, which is also 100% recyclable at the end of its operating life, giving it a true birth to rebirth capability.

We add only moorland rainwater and heat in a production process that uses recovered heat for drying prior to firing to keep environmental impact to a minimum. Choosing Hepworth Clay is the optimum environmental choice.

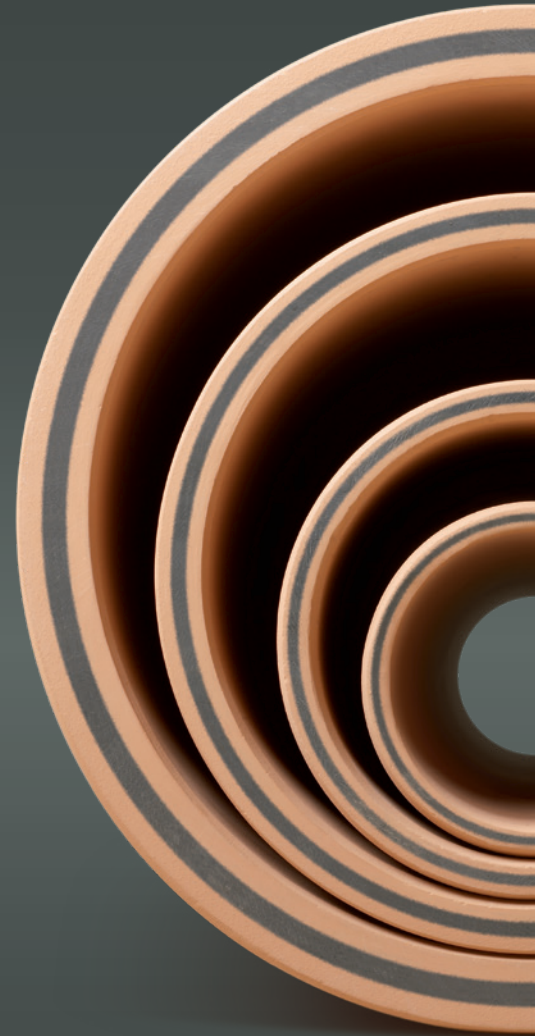

Superior quality

Hepworth Clay products are kitemarked to EN 295-1, have a declaration of performance and CE mark, and are manufactured under a quality system approved to BS EN ISO 9001.

Regular quality checks are made at key stages to guarantee factory process control, with regular ongoing quality audits made by external European and worldwide quality inspectors.

Random sample pipes are crushed to ensure that the strength that is imprinted onto the pipe is delivered to site.

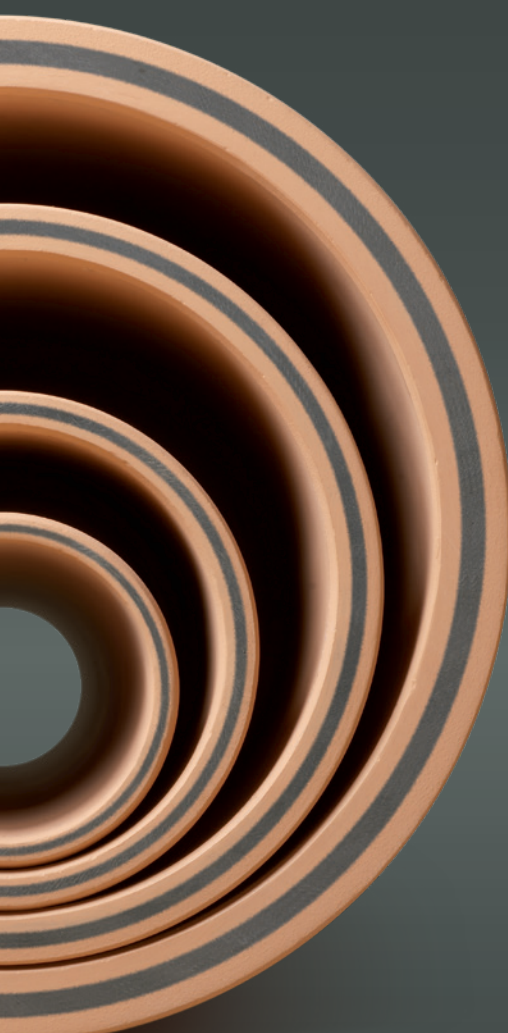

Superior jetting performance

Clay drainage's resistance to high water pressure jetting means more blockages will be cleared first time with reduced risk.

SuperSleve pipe has a Lifetime Jetting Guarantee* 7,500 psi at a flow rate not exceeding 20 gals/min held static for 5 minutes, providing a 50% higher operating pressure than the WRc requirement for clay pipes.

**LIFETIME
GUARANTEE**

**JETPROOF
TO 7,500**

PSI

Superior bedding performance

The natural strength of clay drainage enables recycled aggregate to be used as a bedding material as referenced in BS 9295, reducing costs and environmental impact during the construction process.

The savings can be significant when a full trench depth of granular material can actually be more expensive than the pipe.

Hepworth Clay can advise on the optimum soil and ground conditions from geotechnical reports to establish when this sustainable and cost efficient solution can be deployed.



Superior chemical resistance

Once vitrified, clay is one of the most inert materials on earth, rendering it resistant to almost all chemical attack.

Hepworth Clay is completely unaffected by any effluent allowed in an adoptable sewer system virtually eliminating the risk of exfiltration.

With a resistance to practically all chemicals and compounds that might be found in the ground, clay is the perfect choice when specifying drainage for contaminated brownfield sites.



Lifecycle of Hepworth Clay

Start ▷

Clay mineralogy

The quality of the shale clay deposits we quarry, laid down more than 280 million years ago, are key to the creation of a thin wall product with a high crushing strength, unique to the SuperSieve process.

1

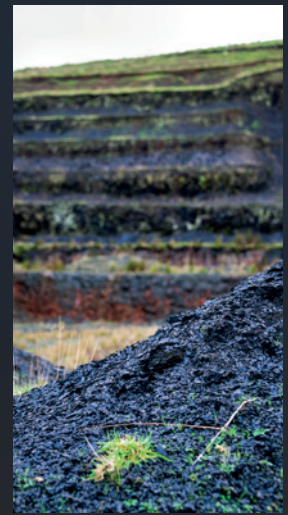

Extrusion and trimming

The powdered clays are mixed with moorland rainwater to exactly 18% moisture content, continuously extruded and are then cut and chamfered to precise lengths. All 'green clay' trimmings return to the raw materials area for re-use.

7



Moorland rainwater use

Moorland rainwater is collected and stored in our on-site reservoir to supply the 50 million litres of water required per year to hydrate the clays in the four roller kilns, minimising embodied CO₂ and raising sustainability.

6

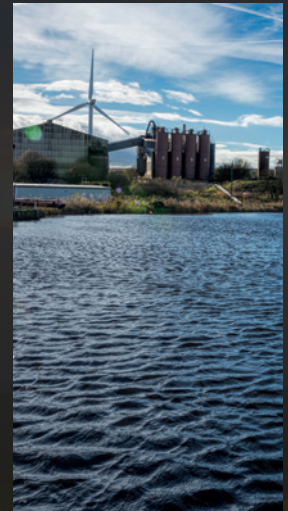

Drying and firing

Heat recovered from the firing kilns is redirected to the drier to help take the water content from 18% to <0.5% and optimise energy use. The entire kiln is angled by 1° so that pipes are rolled and pushed uphill, to maintain dimensional accuracy.

8



Quality inspection

Each pipe is then individually inspected internally and externally for straightness, end imperfections and structural integrity using a ring test.

9



Raw clay to site

Clay with selected properties is sourced from different quarries within a 5 mile radius to minimise embodied CO₂ impact and is then pre-blended.

Process trimmings are reintroduced into the process to further reduce Hepworth's carbon footprint.



2

Blending

A consistent blend is key to consistent product quality, with each blend containing 40 layers to create the required material properties. 15% of fired scrap in each blend acts like the aggregate in concrete and also saves energy during firing.

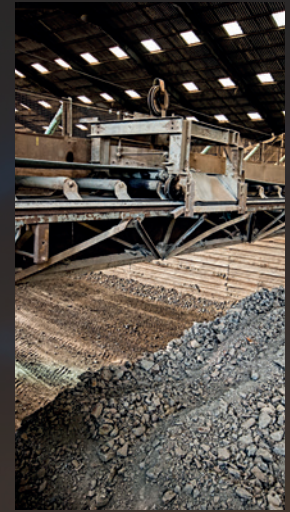

3

Calcination

In a process unique to SuperSieve the clays are then fed into a precipitation calcination plant at high temperatures to reduce impurities. Ball milling then reduces particle size still further; to less than 20 microns.



5

Grinding

The blended clay is then transported to the grinding plant where it is dried and pan ground to a particle size of less than 1.6mm.



4

Manufacturing standards

Clay drainage systems are manufactured and rigorously tested to the highest standards, meeting the requirements of BS EN 295-1 for vitrified clay pipe systems.



10

Quarry aftercare programmes

At our quarries, we work with experts to return previously agricultural land back to natural habitats, create new woodlands and wetlands, re-establish bio-diversity and put aftercare programmes in place for the long term.

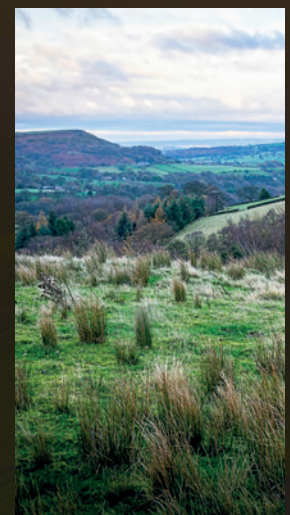

11

Products



Range overview



Foul and surface water systems

SuperSleve 100 to 300mm

The Hepworth SuperSleve clay drainage system is available in 100mm, 150mm, 225mm and 300mm diameters for use in adoptable sewers, commercial or industrial construction, highways and general building drainage.

Comprises a range of vitrified clay pipes both standard and short length, bends, junctions, gullies and adaptors (see below).

- SuperSleve 100mm – plain ended pipes and fittings jointed with push-fit flexible couplings.
- SuperSleve 150mm – plain ended system of pipes, bends and junctions; jointed with push-fit flexible couplings
- SuperSleve 225 and 300mm – pipes, bends and junctions incorporating factory fitted couplings. Plain ended pipes and fittings are also available

Polypropylene push-fit flexible couplings with EPDM rubber sealing rings (supplied as standard) and special purpose Nitrile rubber sealing rings for sites with hydrocarbon contamination, are available for all pipe sizes.



SuperSleve accessories

SuperSleve Gratings & Cover Plates

A range of cover plates, grids and gratings to complement SuperSleve gullies and hoppers (not yard/road gullies).

Clay Channels 100 to 300mm

A range of plain ended or socketed channel fittings for use in foul and surface water manholes and can be used to create a dry weather channel in combined sewers.

Yard/Road Gullies

A range of larger capacity vitrified clay gullies in a variety of sizes suitable for roads, paved areas and car parks, to provide an effective means of collection of surface water into the main drainage system. Vitrified clay and plastic gully options.

Unjointed 100 to 300mm

Traditional spigot and socket pipes, bends, junctions and terminal fittings for use in repair and maintenance work.

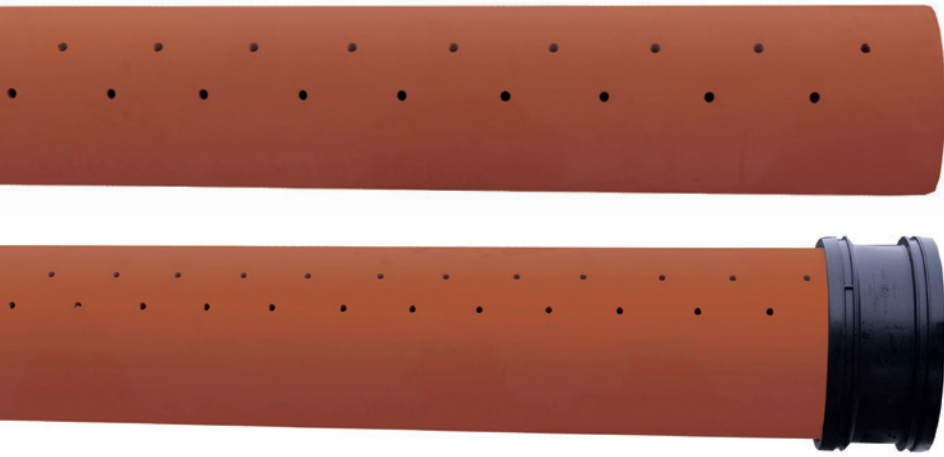

Land Drainage

HepLine 100 to 300mm

A range of plain ended and socketed perforated pipe jointed with standard couplings from the SuperSleve range. Suitable for surface water collection from highways, playing fields, sports grounds, forestry and waste tips and for general land drainage. Can also be used for septic tank effluent dispersal.

System applications

System	Nominal Diameter (mm)	Applications	Specification
SuperSleve	100, 150, 225, 300	Foul and surface water in adoptable sewers, commercial or industrial construction, highways and general building drainage	BS EN 295-1
Clay Channels	100, 150, 225, 300	For use in constructed manholes and as a dry weather channel in combined sewers.	BS 65:1991
Unjointed	100, 150, 225, 300	A traditional system of spigot and sockets for cement mortar jointing, suitable for refurbishment and replacement of traditional drains.	BS 65:1991
HepLine	100, 150, 225, 300	Surface water collection – highways, playing fields, sports grounds, forestry, waste tips and general land drainage. Can also be used for septic tank effluent dispersal.	BS EN 295-5

Inspection Chambers

Shallow Chambers

The Mini Access Chamber (MAC) and Polypropylene Inspection Chamber (PPIC) are designed to be used with SuperSleve clay pipes in private drainage applications subject to Building Regulations Approved Document H. The Mini Access Chamber is suitable for use up to a maximum invert depth of 0.6 metres. The PPIC is suitable for use up to a maximum invert depth of 1.2 metres.

Deep Chambers

The Range 450 inspection chamber bases are designed to be used with 100 and 150mm SuperSleve clay pipes. The Range 600 bases can be used with 150, 225 and 300mm SuperSleve pipes via the appropriate adaptor. Both inspection chambers are suitable for use in adoptable drainage applications subject to Ofwats Code for Adoptable Sewers, Appendix C – Design Construction Guidance up to 1 metre deep, or 3 metres deep with a restriction access cap fitted. They can also be used in private drainage applications up to 1.2 metres deep, or 3 metres deep with a restriction access cap fitted.



Range comparison information

	MAC	PPIC	Range 450	Range 600
Max Invert Depth (m)	0.6	1.2	3.0	3.0
Base/Shaft Dia. (mm)	300	475	450	600
Suitable for:	Building Regulations	Building Regulations	Adoption Type D Building Regulations	Adoption Type D Building Regulations
Inlet Sizes (mm)	100	100/150	100/150	150/225/300
Standards	–	–	BS EN 13598-2	BS EN 13598-2
Product Details (page ref.)	p54-55	p56-61	p62-67	p68-72

Exceptional performance

General

The following performance information relates to Hepworth SuperSleve Clay Drainage systems including the relevant European and British Standards which the products and systems must comply with.

The products meet all the relevant performance levels necessary to comply with the BS EN 295-1. Hepworth Clay products have a design performance far in excess of the specified requirements.

Joint flexibility

Joint assemblies are required to satisfy angular deflection and shear resistance tests to safeguard against both infiltration into and exfiltration from the drainage system.

Joint flexibility is tested in two ways in order to demonstrate resistance to leakage.

These are:

- (a) Angular deflection (BS EN 295-1)
- (b) Shear resistance (BS EN 295-1)

An effective seal must be maintained under internal and external pressures of 5 kPa (0.05 bar) and 50 kPa (0.5 bar) for the specified length of time without visible leakage to meet BS EN 295-1 requirements.

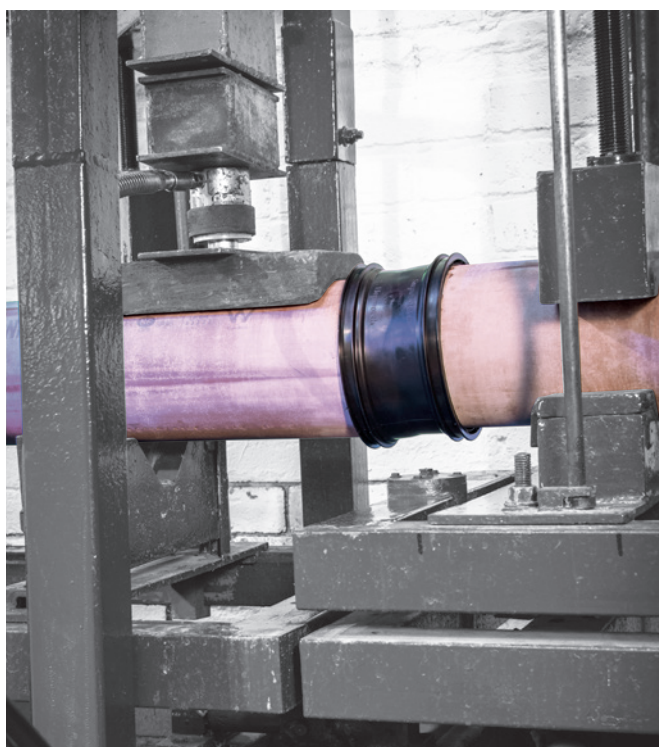

(a) Angular deflection

BS EN 295-1 states deflection limits for the jointing of clay pipes regardless of the type of joint. These are given in Table 1. The assembly is required to stand the relevant test pressures for 5 minutes with no visible leakage. This test simulates the effect of subsidence or subsequent ground movement.

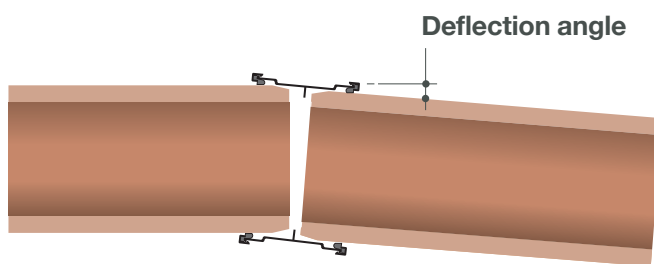

SuperSleve joint

Table 1 – Angular deflection

Nominal Size (mm)	BS EN 295-1
100-200	80mm/m (4.75°)
225-300	30mm/m (1.75°)

Deflection is measured in mm per metre deflected pipe length.

(b) Shear resistance

BS EN 295-1 requires that a vertical load of 25 N per mm of nominal pipe size (e.g. 250 kg for DN100, 750 kg for DN300) is applied to the joint assembly with no visible leakage. The assembly is required to stand the relevant test pressure for 15 minutes with no visible leakage.

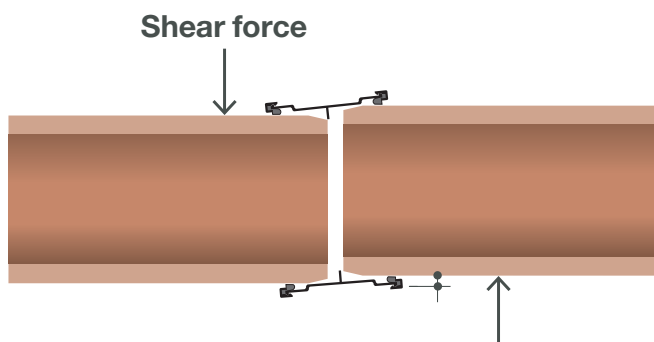

SuperSleve joint

Shear force

Note that differential movement can occur when pipes enter buildings or connect with an inspection chamber, manhole, wall or other structure.

This movement must be allowed for. For further details see Pipes Passing through Structures: Technical Note 3 page 101.

Strength

Performance parameters are laid down in Table 2. All Hepworth Clay pipes meet the criteria specified in BS EN 295-1, and in many cases are well in excess of the stated level of performance.

Abrasion resistance

Erosion of vitrified clay pipes in use is minimal and seldom needs to be considered during design. For special circumstances of application the values of average abrasion resistance can be determined from the test methods in BS EN 295-3.

Flow characteristics

The flow properties of all clay pipes have been assessed using the Colebrook-White formula shown in BS EN 16933-2.

Recommended roughness values (ks) are:

Foul and combined sewers:

- ks = 1.5mm at velocity less than 1m/s
- ks = 0.6mm at velocity greater than 1m/s

Surface water sewers:

- ks = 0.6mm

All pipes and fittings have a low hydraulic roughness. Further information on hydraulic design can be found on page 80 in the Design section.

Watertightness of pipe, bends and junctions

Hepworth clay pipes are tested for impermeability using an air and water test.

BS EN 295-1 Air Test: The pipes, bends and junctions are subjected to an initial air pressure of 100mm water gauge, which may not drop below 75mm water gauge in 5 minutes.

Water Test: The pipes, bends and junctions are required to withstand an internal water pressure of 50 kPa (0.5 bar) for 15 minutes without leakage.

Bond strength

Where fittings are made up by assembling fired clay parts together, BS EN 295-1 requires the bending tensile strength of both the adhesive and the adhesive/clay interface to be tested. Neither the adhesive nor the adhesive/clay interface should fracture under a bending tensile stress of 5 N/mm².

Loading

Pipes specified in BS EN 295-1 are resistant to fatigue from pulsating loads found under highways and railways.

Durability

Properly designed, constructed, operated and maintained systems incorporating Hepworth Clay products have a design life expectancy well in excess of 100 years as supported by BS EN 295-1 / annex B.6 economy.

This longevity is due to the material characteristics and strength of vitrified clay pipe and fittings which does not change after manufacture and installation.

The range offers the designer products that are capable of withstanding most structural situations combined with trouble-free performance in the most arduous of conditions.

Table 2 – Crushing strength and bending moment resistance

Range	Nominal Diameter (mm)	Crushing Strength (kN/m)	BS EN 295 Class No.	Bending Moment Resistance (kNm)
SuperSleve	100	40	–	2.00
	150	40	–	5.00
	225	45	200	9.00
	300	72	240	–
HepLine	100	28	–	–
	150	28	–	–
	225	36	–	–
	300	48	–	–

Product details – Introduction

Descriptions

Descriptions and illustrations in this publication are for guidance only.

- The fittings illustrated are indicated by a **bold Cat No.**

No responsibility can be accepted for any errors or omissions. Refer to the product itself if more detailed information is required. Due to the continuing programme of product improvement the Company reserves the right to amend any published information or to modify any product without prior notice.

Dimensions

Unless otherwise stated all dimensions are in millimetres (mm).

Symbols of certification

a) British Standard Kitemark

Identifies pipes and fittings which are manufactured under the BSI Certification Scheme.

b) CE Mark

Identifies products covered by a CE mark.

c) Lifetime Jetting Guarantee

Identifies products that are guaranteed* for the system lifetime against penetration of the pipe wall caused by the following jetting criteria:

- High pressure water jet used at a pressure of up to 7500 psi (517 bar)
- At a flow rate not exceeding 20 gallons per minute (1.5 litres per second)
- Held immobile for a constant period of not more than 5 minutes

* When laid in accordance with our instructions and the requirements of the codes of practice and guides relevant to their use.



Standards

Hepworth Clay drainage systems comply, where applicable, with the requirements of the following British Standards:

SuperSleve pipe and polypropylene couplings

BS EN 295-1:2013

Vitrified clay pipe systems for drains and sewers. Part 1: Requirements for pipes, fittings and joints.

Rubber sealing rings

BS EN 681-1:1996

Elastomeric seals. Material requirements for pipe joint seals used in water and drainage applications. Part 1: Vulcanized rubber.

HepLine

BS EN 295-5:2013

Vitrified clay pipe systems for drains and sewers. Part 5: Requirements for perforated pipes and fittings.

Clay Channel, Unjointed

BS 65:1991

Specification for vitrified clay pipes, fittings and ducts, also flexible mechanical joints for use solely with surface water pipes and fittings.

Quality assurance

Hepworth Clay pipes are manufactured on a site whose carbon emissions have been independently verified to UK ETS, earning it the CICS Carbon Verified Assurance Mark.

All products are manufactured under a quality management system which is approved to **BS EN ISO 9001** Quality Management Systems – Requirements. Certificate No. FM00217.

All Wavin manufacturing sites operate Environmental Management Systems which comply with the requirements of and are certified to **BS EN ISO 14001**, Certificate No. 42231.

SuperSleeve

Product Details

Pipes

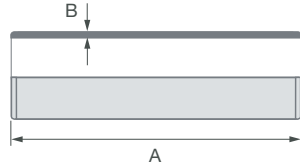
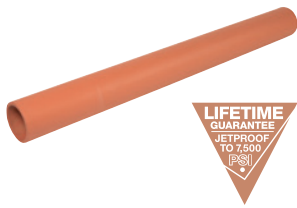

Plain Ended Pipe

Material: Vitrified clay

Nominal Dia (mm)	Cat No.	Certs.	Dimensions (mm)	
			A	B
100	SP1	CE	1600	11
150	SP2	CE	1750	14
225	SP4	CE	2000	19
300	SP7	CE	2000	29

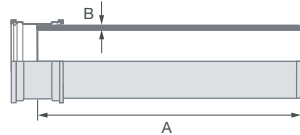

Socketed Pipe

Material: Vitrified clay

Nominal Dia (mm)	Cat No.	Certs.	Dimensions (mm)	
			A	B
225	SP4S	CE	2000	19
300	SP7S	CE	2000	29

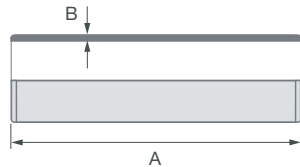

Plain Ended Rocker Pipes

Material: Vitrified clay

Nominal Dia (mm)	Cat No.	Certs.	Dimensions (mm)	
			A	B
100	SP060/1	CE	600	11
150	SP060/2	CE	600	14
225	SP060/5	CE	600	19
300	SP060/7	CE	600	29



Socketed Rocker Pipes

Material: Vitrified clay

Nominal Dia (mm)	Cat No.	Certs.	Dimensions (mm)	
			A	B
225	SP060/5S	CE	600	19
300	SP060/7S	CE	600	29

Couplings

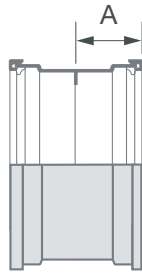

EPDM Sealing Rings

Material: Polypropylene

Nominal Dia (mm)	Cat No.	Certs.		Dimensions (mm)	
				A	
100	SC1/1	✓	CE	45	
150	SC1/2	✓	CE	55	
225	SC1/5	✓	CE	75	
300	SC1/7	✓	CE	100	

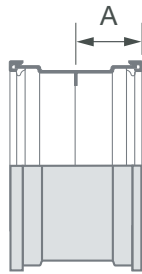

Nitrile Sealing Rings

- For applications involving petrol, diesel and oil type contamination either in the ground or the effluent
- See page 91 for guidance
- SL1C high performance lubricant should be used for installation

Material: Polypropylene

Nominal Dia (mm)	Cat No.	Certs.		Dimensions (mm)	
				A	
100	SC3/1	✓	CE	45	
150	SC3/2	✓	CE	55	
225	SC3/5	✓	CE	75	
300	SC3/7	✓	CE	100	

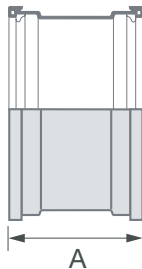

Sliding Couplings

- For new branch entries and repairs

Material: Polypropylene

Nominal Dia (mm)	Cat No.	Certs.		Dimensions (mm)	
				A	
100	SC4/1	✓	CE	90	
150	SC4/2	✓	CE	110	

Bends

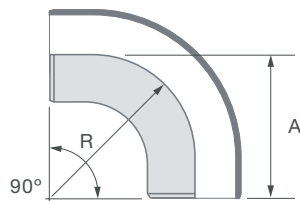

90° Plain Ended Bend

Material: Vitrified clay

Nominal Dia (mm)	Cat No.	Certs.		Dimensions (mm)	
				A	R
100	SB1/1	✓	CE	195	150
150	SB1/2	✓	CE	285	230
225	SB1/5	✓	CE	335	235
300	SB1/7	✓	CE	470	320

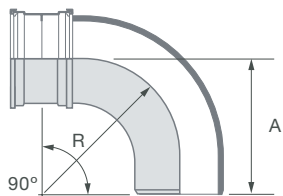

90° Socketed Bend

Material: Vitrified clay

Nominal Dia (mm)	Cat No.	Certs.		Dimensions (mm)	
				A	R
225	SB1/5S	✓	CE	335	235
300	SB1/7S	✓	CE	470	320

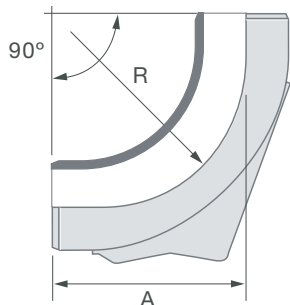

90° Plain Ended Rest Bend

Material: Vitrified clay

Nominal Dia (mm)	Cat No.	Certs.		Dimensions (mm)	
				A	R
100	SBR1	✓	CE	225	215
150	SBR2	✓	CE	270	230

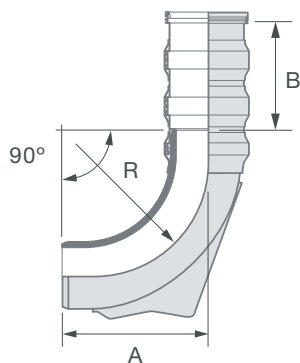

90° Telescopic Rest Bend

- For use where either ground settlement or clay heave is anticipated
- See page 113 for installation guidance

Material: Vitrified clay

Nominal Dia (mm)	Cat No.	Certs.		Dimensions (mm)		
				A	B	R
100	SBRT1	✓	CE	255	180	215
150	SBRT2	✓	CE	270	230	230

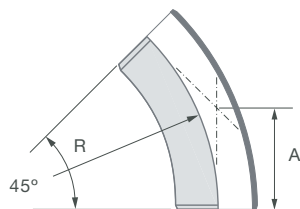

45° Plain Ended Bend

Material: Vitrified clay

Nominal Dia (mm)	Cat No.	Certs.		Dimensions (mm)	
				A	R
100	SB2/1	✓	CE	107	150
150	SB2/2	✓	CE	150	230
225	SB2/5	✓	CE	200	235
300	SB2/7	✓	CE	286	320

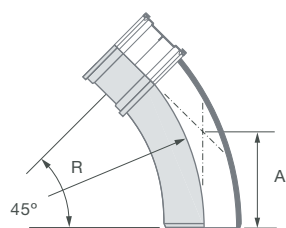

45° Socketed Bend

Material: Vitrified clay

Nominal Dia (mm)	Cat No.	Certs.		Dimensions (mm)	
				A	R
225	SB2/5S	✓	CE	200	235
300	SB2/7S	✓	CE	286	320

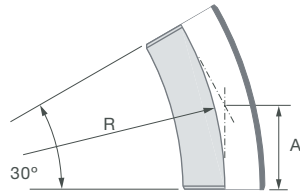

30° Plain Ended Bend

Material: Vitrified clay

Nominal Dia (mm)	Cat No.	Certs.		Dimensions (mm)	
				A	R
100	SB3/1	✓	CE	95	150
150	SB3/2	✓	CE	117	230
225	SB3/5	✓	CE	160	235
300	SB3/7	✓	CE	230	320

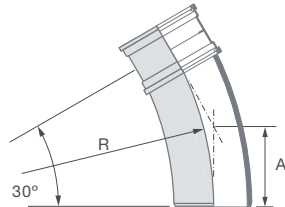

30° Socketed Bend

Material: Vitrified clay

Nominal Dia (mm)	Cat No.	Certs.		Dimensions (mm)	
				A	R
225	SB3/5S	✓	CE	160	235
300	SB3/7S	✓	CE	230	320

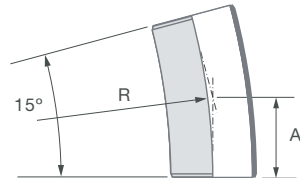

15° Plain Ended Bend

Material: Vitrified clay

Nominal Dia (mm)	Cat No.	Certs.		Dimensions (mm)	
				A	R
100	SB4/1	✓	CE	90	150
150	SB4/2	✓	CE	100	230
225	SB4/5	✓	CE	130	235
300	SB4/7	✓	CE	195	320

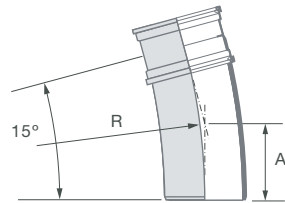

15° Socketed Bend

Material: Vitrified clay

Nominal Dia (mm)	Cat No.	Certs.		Dimensions (mm)	
				A	R
225	SB4/5S	✓	CE	130	235
300	SB4/7S	✓	CE	195	320

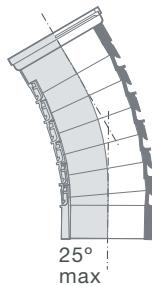

Flexible Bend (0-25°)

Material: Polypropylene

Nominal Dia (mm)	Cat No.	Certs.		Dimensions (mm)	
				A	R
100	SFB1/1			300*	

*A = Effective length when straight

Junctions

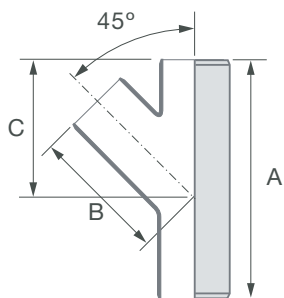

Equal 45° Oblique Junctions – Plain Ended

Material: Vitrified clay

Nominal Dia (mm)	Cat No.	Certs.	Dimensions (mm)		
			A	B	C
100 x 100	SJ1/1	CE	350	250	250
150 x 150	SJ1/3	CE	450	340	340
225 x 225	SJ1/9	CE	650	475	450
300 x 300	SJ1/19	CE	800	600	600

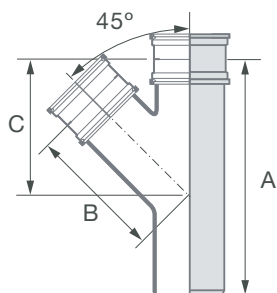

Equal 45° Oblique Junctions – Socketed

Material: Vitrified clay

Nominal Dia (mm)	Cat No.	Certs.	Dimensions (mm)		
			A	B	C
225 x 225	SJ1/9D	CE	650	475	450
300 x 300	SJ1/19D	CE	800	600	600

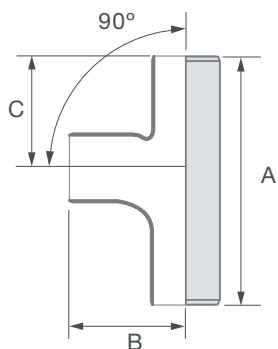

Equal 90° Square Junctions – Plain Ended

Material: Vitrified clay

Nominal Dia (mm)	Cat No.	Certs.	Dimensions (mm)		
			A	B	C
100 x 100	SJ2/1	CE	350	175	175
150 x 150	SJ2/3	CE	450	225	210
225 x 225	SJ2/9	CE	650	475	360
300 x 300	SJ3/19	CE	800	400	400

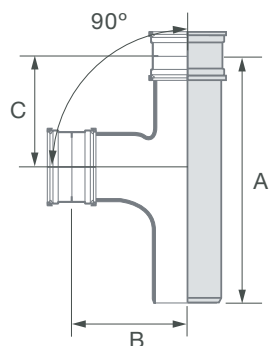

Equal 90° Square Junctions – Socketed

Material: Vitrified clay

Nominal Dia (mm)	Cat No.	Certs.	Dimensions (mm)		
			A	B	C
225 x 225	SJ2/9D	CE	650	475	360
300 x 300	SJ3/19D	CE	800	400	400

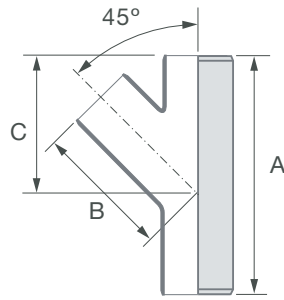

Unequal 45° Oblique Junctions – Plain Ended

Material: Vitrified clay

Nominal Dia (mm)	Cat No.	Certs.		Dimensions (mm)		
				A	B	C
150 x 100	SJ1/2	✓	CE	450	300	300
225 x 100	SJ1/7	✓	CE	450	360	320
225 x 150	SJ1/8	✓	CE	450	375	375
300 x 100	SJ1/14	✓	CE	600	485	450
300 x 150	SJ1/15	✓	CE	600	485	500
300 x 225	SJ1/17	✓	CE	800	600	500

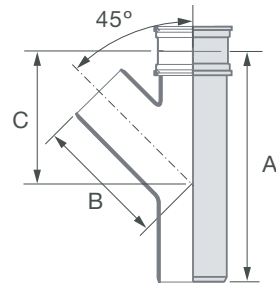

Unequal 45° Oblique Junctions – Socketed

- SJ1/17D is supplied with a coupling on the barrel and arm

Material: Vitrified clay

Nominal Dia (mm)	Cat No.	Certs.		Dimensions (mm)		
				A	B	C
225 x 100	SJ1/7S	✓	CE	450	360	320
225 x 150	SJ1/8S	✓	CE	450	375	375
300 x 100	SJ1/14S	✓	CE	600	485	450
300 x 150	SJ1/15S	✓	CE	600	485	500
300 x 225	SJ1/17D	✓	CE	800	600	500

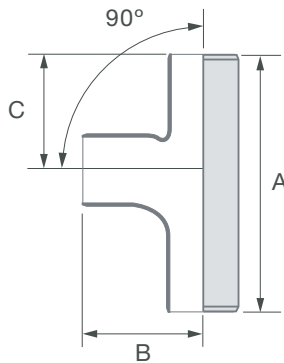

Unequal 90° Square Junctions – Plain Ended

Material: Vitrified clay

Nominal Dia (mm)	Cat No.	Certs.		Dimensions (mm)		
				A	B	C
150 x 100	SJ2/2	✓	CE	450	225	185
225 x 100	SJ3/7	✓	CE	450	225	215
225 x 150	SJ3/8	✓	CE	450	225	220
300 x 100	SJ3/14	✓	CE	600	300	310
300 x 150	SJ3/15	✓	CE	600	275	320
300 x 225	SJ3/17	✓	CE	600	300	290

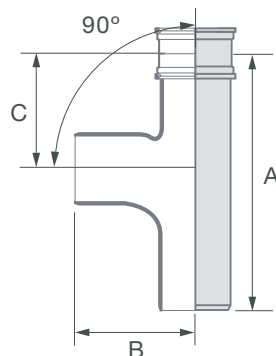

Unequal 90° Square Junctions – Socketed

- SJ3/17D is supplied with a coupling on the barrel and arm

Material: Vitrified clay

Nominal Dia (mm)	Cat No.	Certs.		Dimensions (mm)		
				A	B	C
225 x 100	SJ3/7S	✓	CE	450	225	215
225 x 150	SJ3/8S	✓	CE	450	225	220
300 x 100	SJ3/14S	✓	CE	600	300	310
300 x 150	SJ3/15S	✓	CE	600	275	320
300 x 225	SJ3/17D	✓	CE	600	300	290

Saddles

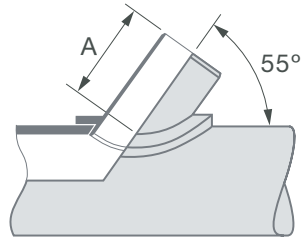

Oblique Saddles – Small

• For pipes up to and including 300mm diameter

Material: Vitrified clay

Nominal Dia (mm)	Cat No.	Certs.		Dimensions (mm)
				A
100	SJS1/1	✔	CE	150
150	SJS1/2	✔	CE	190

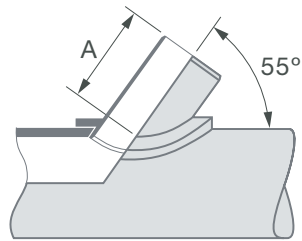

Oblique Saddles – Large

• For pipes larger than 300mm diameter

Material: Vitrified clay

Nominal Dia (mm)	Cat No.	Certs.		Dimensions (mm)
				A
100	SJS2/1	✔	CE	150
150	SJS2/2	✔	CE	190

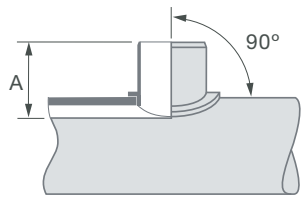

Square Saddles – Small

• For pipes up to and including 300mm diameter

Material: Vitrified clay

Nominal Dia (mm)	Cat No.	Certs.		Dimensions (mm)
				A
100	SJS4/1	✔	CE	100
150	SJS4/2	✔	CE	120

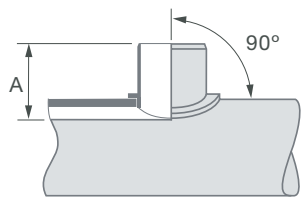

Square Saddles – Large

• For pipes larger than 300mm diameter

Material: Vitrified clay

Nominal Dia (mm)	Cat No.	Certs.		Dimensions (mm)
				A
100	SJS5/1	✔	CE	100
150	SJS5/2	✔	CE	120
225	SJS5/5	✔	CE	210
300	SJS5/7	✔	CE	230

Taper Pipe

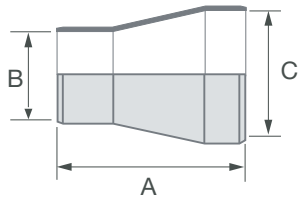

Taper Pipe – Plain Ended

Material: Vitrified clay

Nominal Dia (mm)	Cat No.	Certs.		Dimensions (mm)		
				A	B	C
100-150	ST2/1	♥	CE	250	100	150
150-225	ST3/2	♥	CE	450	150	225
225-300	ST4/3	♥	CE	550	225	300

Socket Adaptor

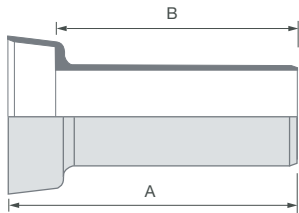

Socket Adaptor

Material: Vitrified clay

Nominal Dia (mm)	Cat No.	Certs.		Dimensions (mm)	
				A	B
100	SA1/1	♥	CE	370	310
150	SA1/2	♥	CE	365	305
225	SA1/5	♥	CE	670	600
300	SA1/7	♥	CE	680	600

Traps

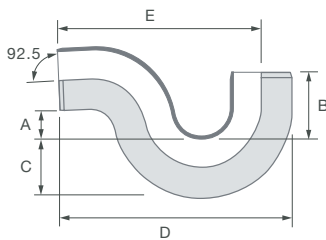

Low Back P-Trap – Plain Ended

Material: Vitrified clay

Nominal Dia (mm)	Cat No.	Certs.		Dimensions (mm)		
				A	B	C
100	SG1/1	♥	CE	50 min	120 min	100
150	SG1/2	♥	CE	50 min	120 min	150
				D	E	
				460	400	
				555	470	

Gullies

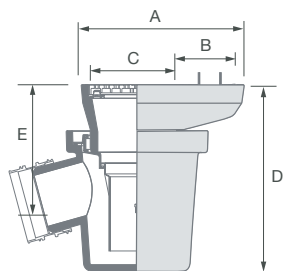

Inlet Gully

- Trapped roddable gully
- Rotating top supplied complete with secure polypropylene grating

Material: Vitrified clay

Nominal Dia (mm)	Cat No.	Certs.		Dimensions (mm)		
				A	B	C
100	SDG3/1			300	150	150
				x195	x90	x150
				D	E	
				345	245	

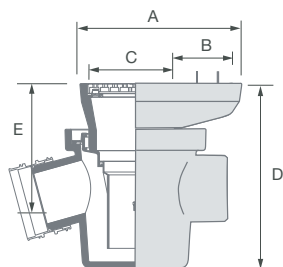

Inlet Gully with Horizontal Back Inlet

Material: Vitrified clay

Nominal Dia (mm)	Cat No.	Certs.		Dimensions (mm)		
				A	B	C
100	SDG3/2			300	150	150
				x195	x90	x150
				D	E	
				345	245	

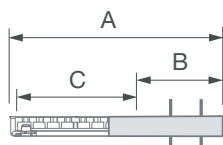

Grid and Vertical Back Inlet Insert Only

- Spare for use with the SDG3/1 and SDG3/2 gullies

Material: Polypropylene

Nominal Dia (mm)	Cat No.	Certs.		Dimensions (mm)		
				A	B	C
-	SDG10			270	150	150
				x170	x90	x150

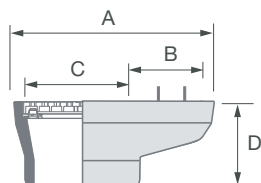

Hopper Complete with Grid and Vertical Back Inlet Insert

- Spare for use with the SDG3/1 and SDG3/2 gullies

Material: Vitrified clay

Nominal Dia (mm)	Cat No.	Certs.		Dimensions (mm)		
				A	B	C
-	SDG2/6			300	150	150
				x195	x90	x150
				D		
				125		



Cover Plate

- For use with the inlet and paved area gullies

Material: Polypropylene

Nominal Dia (mm)	Cat No.	Certs.		Dimensions (mm)
				A
-	SDG2/4			150x150

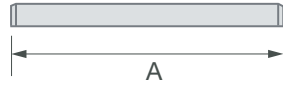

Metal Grid

- For use with the inlet and paved area gullies

Material: Metal

Nominal Dia (mm)	Cat No.	Certs.	Dimensions (mm)	
			A	
-	SDG2/5		150x150	

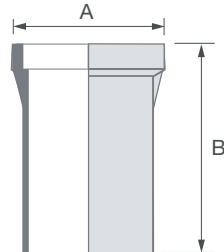

Dip Tube Trap

- Spare for use with the inlet and paved area gullies

Material: Polypropylene

Nominal Dia (mm)	Cat No.	Certs.	Dimensions (mm)	
			A	B
135	SDC6		135	170

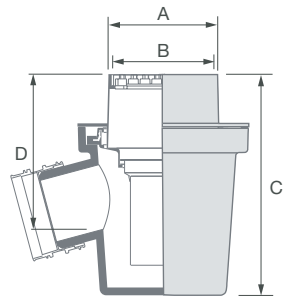

Paved Area Gully

- Trapped roddable gully used to collect surface water from hardstanding areas up 50m²
- Square top enables neat finish with block paving

Material: Vitrified clay

Nominal Dia (mm)	Cat No.	Certs.	Dimensions (mm)		
			A	B	C
100	SDG2/1	✓ CE	168	150 x150	345
			D		
			245		

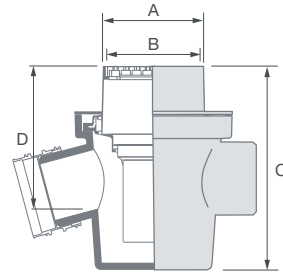

Paved Area Gully with Horizontal Back Inlet

Material: Vitrified clay

Nominal Dia (mm)	Cat No.	Certs.	Dimensions (mm)		
			A	B	C
100	SDG2/3	✓ CE	168	150 x150	345
			D		
			245		

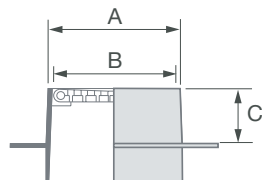

Top Assembly Complete with Grid and Frame

- Spare for use with the SDG2/1 and SDG2/3 gullies

Material: Polypropylene

Nominal Dia (mm)	Cat No.	Certs.	Dimensions (mm)		
			A	B	C
-	SDG2/2		168	150 x150	70

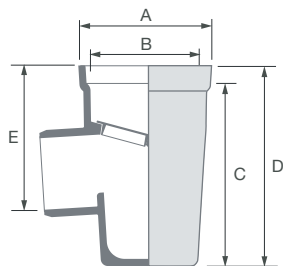

Square Gully

- Trapped roddable gully
- Secure friction fit polypropylene grating
- Grating has cut out options to take either waste water or rainwater pipes up to 68mm
- See page 34 for additional metal cover and grid options

Material: Vitrified clay

Nominal Dia (mm)	Cat No.	Certs.	Dimensions (mm)		
			A	B	C
100	SG2/1		188	159	255
			D	E	
			280	200	

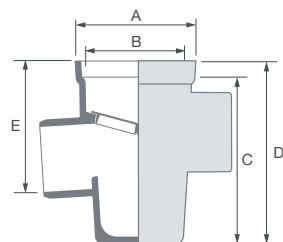

Square Gully with Horizontal Back Inlet

- See page 34 for additional metal cover and grid options

Material: Vitrified clay

Nominal Dia (mm)	Cat No.	Certs.	Dimensions (mm)		
			A	B	C
100	SG2/2		188	159	255
			D	E	
			280	200	



Spare Polypropylene Grid

- Spare for use with the SG2/1 and SG2/2 gullies
- See page 34 for metal grid options

Material: Polypropylene

Nominal Dia (mm)	Cat No.	Certs.	Dimensions (mm)
			A
-	SG2/5		159 x 159

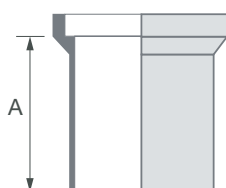

Square Raising Piece

- For use with the SG2/1 and SG2/2 gullies and SH1 and SH2 hoppers

Material: Vitrified clay

Nominal Dia (mm)	Cat No.	Certs.	Dimensions (mm)
			A
150 x 150	RRS2/1		75
150 x 150	RRS2/2		150
150 x 150	RRS2/3		225
150 x 150	RRS2/4		300

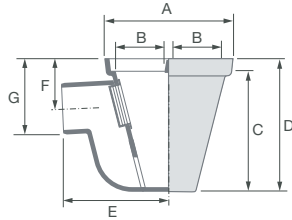

Access Gully

- Trapped roddable gully
- Can accept rainwater pipes up to 100mm square
- See page 34 for additional metal cover and grid options

Material: Vitrified clay

Nominal Dia (mm)	Cat No.	Certs.	Dimensions (mm)			
			A	B	C	
100	SG3/1		CE	305 x160	105 x105	290
				D	E	F
				315	270	125
				G		
				175		

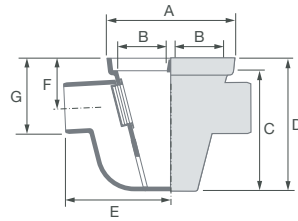

Access Gully with Horizontal Back Inlet

- See page 34 for additional metal cover and grid options

Material: Vitrified clay

Nominal Dia (mm)	Cat No.	Certs.	Dimensions (mm)			
			A	B	C	
100	SG4/1		CE	305 x160	105 x105	290
				D	E	F
				315	270	125
				G		
				175		

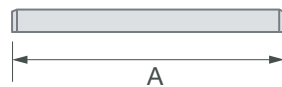

Spare Polypropylene Grid

- Spare for use with the SG3/1 and SG4/1 gullies and SH3/1 and SH3/2 hoppers

Material: Polypropylene

Nominal Dia (mm)	Cat No.	Certs.	Dimensions (mm)
			A
-	IG1P		120 x 120



Spare Polypropylene Bridge

- Spare for use with the SG3/1 and SG4/1 gullies and SH3/1 hopper

Material: Polypropylene

Nominal Dia (mm)	Cat No.	Certs.	Dimensions (mm)
			A
-	QB1		270 x 120

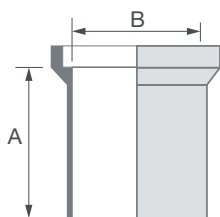

Hoppers

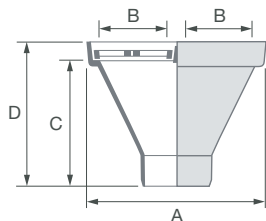

Access Raising Piece

- For use with the SG3/1 and SG4/1 gullies and the SH3/1 hopper

Material: Vitrified clay

Nominal Dia (mm)	Cat No.	Certs.	Dimensions (mm)	
			A	B
-	SRP5	✓	75	265x120
-	SRP6	✓	150	265x120
-	SRP7	✓	225	265x120
-	SRP8	✓	300	265x120

Rectangular Hopper

- See page 34 for additional metal cover and grid options

Material: Vitrified clay

Nominal Dia (mm)	Cat No.	Certs.	Dimensions (mm)		
			A	B	C
100	SH3/1	✓ CE	305 x160	105 x105	215
150	SH3/2	✓ CE	410 x210	155 x155	205
			D		
			215		
			230		

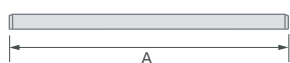

Spare Polypropylene Bridge

- Spare for SH3/2 hopper

Material: Polypropylene

Nominal Dia (mm)	Cat No.	Certs.	Dimensions (mm)
			A
-	QB2		375x175

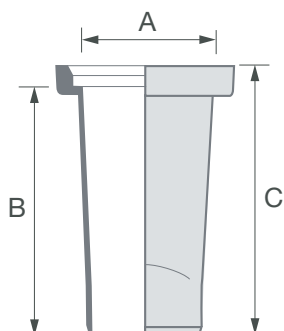

Square Hopper

- See page 34 for additional metal cover and grid options

Material: Vitrified clay

Nominal Dia (mm)	Cat No.	Certs.	Dimensions (mm)		
			A	B	C
100	SH1	✓ CE	135 x135	245	270

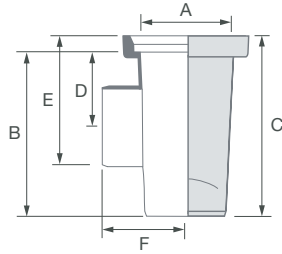

Square Hopper with Horizontal Inlet

- See page 34 for additional metal cover and grid options

Material: Vitrified clay

Nominal Dia (mm)	Cat No.	Certs.		Dimensions (mm)		
				A	B	C
100	SH2			135 x135	245	270
				D	E	F
				110	185	140

Stoppers



100 and 150mm stopper



225 and 300mm stopper



Stopper

- 100 and 150mm stoppers fit over the end of the pipe
- 225 and 300mm stoppers push into a SuperSleve socket

Material: Polypropylene* / Vitrified clay†

Nominal Dia (mm)	Cat No.	Certs.		Dimensions (mm)
				A
100	SS1/1*			45
150	SS1/2*			55
225	SS3/4†			75
300	SS3/7†			100



Testing Stopper

- The testing stopper has an integral nipple suitable for a push fit connection to a hose
- Stoppers fit over the end of the pipe

Material: Polypropylene

Nominal Dia (mm)	Cat No.	Certs.		Dimensions (mm)
				A
100	SS2/1			45
150	SS2/2			55

Rodding Points

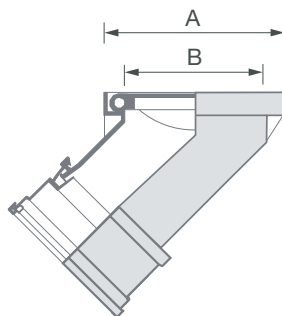

Rodding Point

- Air tight secure square top, fits neatly into block paving
- Complete with fitted coupling to connect directly to SuperSleve

Material: Polypropylene

Nominal Dia (mm)	Cat No.	Certs.		Dimensions (mm)	
				A	B
100	SRPS1/1			164x164	120x90

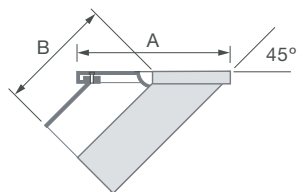

Oval Rodding Point

- The SRP2/1 incorporates a rubber seal making it airtight

Material: Aluminium

Nominal Dia (mm)	Cat No.	Certs.	Dimensions (mm)	
			A	B
100	SRP1/1		190x140	130
100	SRP2/1		190x140	130
150	SRP1/2		270x200	180

Drain Connectors

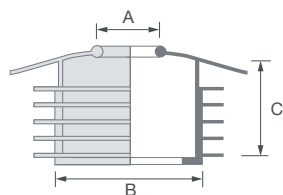

Internal Drain Connector to Waste Pipes

- For connecting 32mm up to 50mm waste pipe to a 100mm plain ended SuperSleve pipe

Material: Polypropylene / rubber

Nominal Dia (mm)	Cat No.	Certs.	Dimensions (mm)		
			A	B	C
100	S/S460		32-40	90	60
100	S/S462		50	90	60

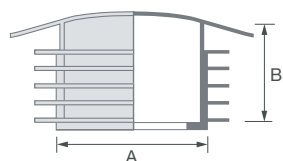

Internal Blanking Plug

- Pushes into a 100mm plain ended SuperSleve pipe

Material: Polypropylene / rubber

Nominal Dia (mm)	Cat No.	Certs.	Dimensions (mm)	
			A	B
100	S/S89		90	65

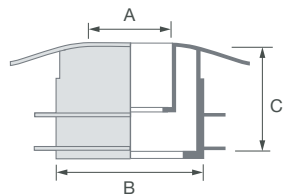

Internal Drain Connector to Rainwater Pipes

- For connecting 68mm round or 65mm square rainwater pipes to a 100mm plain ended SuperSleve pipe

Material: Polypropylene

Nominal Dia (mm)	Cat No.	Certs.	Dimensions (mm)		
			A	B	C
100	S/4A06B		68 Rd	92	53
100	S/4A06C		65 Sq	92	53

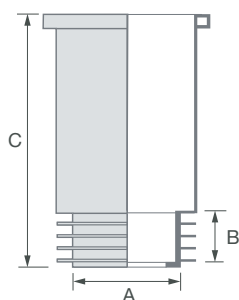

Internal Drain Connector to Soil Stack

- For connecting 110mm PVC-U soil stack to 100mm SuperSleve pipe

Material: Polypropylene / rubber

Nominal Dia (mm)	Cat No.	Certs.	Dimensions (mm)		
			A	B	C
100	S/S464		92	55	175

Adaptors

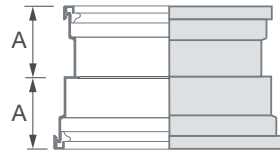

SuperSleve Adaptor to HepSleve

- 100mm SuperSleve OD is 122mm and HepSleve is 132mm
- 150mm SuperSleve OD is 178mm and HepSleve is 188mm

Material: Polypropylene

Nominal Dia (mm)	Cat No.	Certs.	Dimensions (mm)	
			A	
100	SA3/1		45	
150	SA3/2		55	

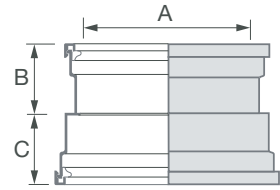

SuperSleve Adaptor to Soil/Drain Pipes

Material: Polypropylene

Nominal Dia (mm)	Cat No.	Certs.	Dimensions (mm)		
			A	B	C
100	SA9		106	55	45
150	SA10		157	55	55

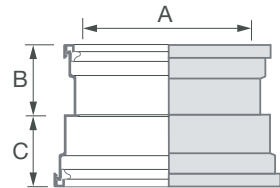

HepSleve Adaptor to Soil/Drain Pipes

- HepSleve is 132mm / 110mm soil/drain pipe
- HepSleve is 188mm / 160mm soil/drain pipe

Material: Polypropylene

Nominal Dia (mm)	Cat No.	Certs.	Dimensions (mm)		
			A	B	C
100	VA9		106	55	45
150	VA10		157	55	55

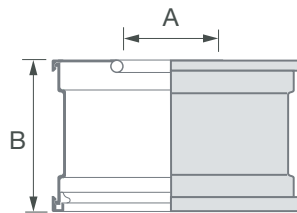

Rainwater Adaptor

- SA11 will accept round or square rainwater pipes up to 76mm
- SA11 fits over a 100mm SuperSleve pipe
- SA21 accepts pipes up to 100mm square
- SA21 pushes inside a 150mm SuperSleve pipe

Material: Polypropylene

Nominal Dia (mm)	Cat No.	Certs.	Dimensions (mm)	
			A	B
100	SA11		45	80
150	SA21		75	100

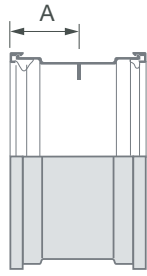

Adaptor to Cast Iron

- Adaptor to cast iron pipes manufactured to BS 437

Material: Polypropylene

Nominal Dia (mm)	Cat No.	Certs.	Dimensions (mm)	
			A	
100	SA14/1		45	
150	SA14/2		55	

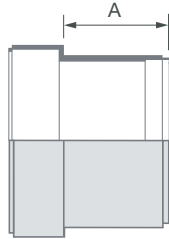

Double Ended Spigot Adaptor

- For connecting SuperSleve pipes to OsmaDrain pipes

Material: Polypropylene

Nominal Dia (mm)	Cat No.	Certs.	Dimensions (mm)	
			A	
100	SA15/1		65	
150	SA15/2		80	

Access Fittings

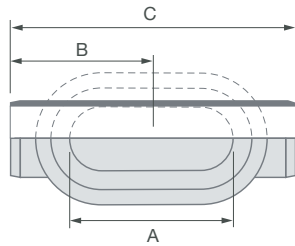

Access Pipe

Material: Vitrified clay

Nominal Dia (mm)	Cat No.	Certs.	Dimensions (mm)		
			A	B	C
100	SPA1	CE	260 x100	225	450
150	SPA2	CE	260 x100	253	505

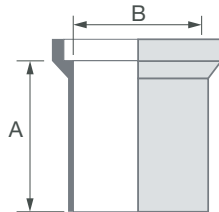

Access Raising Piece

- For use with access pipe, bends and junctions to adjust the height

Material: Vitrified clay

Nominal Dia (mm)	Cat No.	Certs.	Dimensions (mm)	
			A	B
-	SRP1		75	260x100
-	SRP2		150	260x100
-	SRP3		225	260x100



Alloy Lid and Frame

- For use with access pipe, bends and junctions

Material: Aluminium



Nominal Dia (mm)	Cat No.	Certs.	Dimensions (mm)	
			A	
-	ISO		300x150	

SuperSleve Gratings and Cover Plates

Product Details

Gratings and Cover Plates

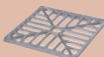
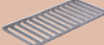
Grids, Gratings and Cover Plates for use with SuperSleve Gullies and Hoppers

Grating	Gully Size (mm)	Grid/Frame Size (mm)	Cat No		Suitable for Gully Types						
			Alloy	Cast Iron	SH1	SH2	SH3/1	SG2/1	SG2/2	SG3/1	SG4/1
Square Grid 	100	120	IG1	IG1C	-	-	✓	-	-	✓	✓
	150	150	IG2	IG2C	✓	✓	-	✓	✓	-	-
Rectangular Grid 	-	265 x 120	IG5	-	-	-	✓	-	-	✓	✓
Hinged Grating and Frame – square 	100	120	IH1	-	-	-	✓	-	-	✓	✓
	150	150	IH2	IH2C	✓	✓	-	✓	✓	-	-
Cover Plate and Frame – square 	-	120	IS1	-	-	-	✓	-	-	✓	✓
	-	150	IS2	-	✓	✓	-	✓	✓	-	-



Gully Grid – Square

- For use in pedestrian areas only

Material: Aluminium

Cat No.	Dimensions (mm)	
	A	B
IG1	120 x 120	8
IG2	150 x 150	8
IG3	229 x 229	10



Gully Grid – Square

- For use in pedestrian areas only

Material: Cast Iron

Cat No.	Dimensions (mm)	
	A	B
IG1C	120 x 120	13
IG2C	150 x 150	15
IG3C	229 x 229	15
IG4C	323 x 323	15



Gully Grid – Square

- For use in pedestrian areas only

Material: Galvanised

Cat No.	Dimensions (mm)	
	A	B
IG2G	150 x 150	13

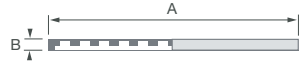

Gully Grid – Rectangular

- For use in pedestrian areas only

Material: Aluminium

Cat No.	Dimensions (mm)	
	A	B
IG5	265 x 120	8

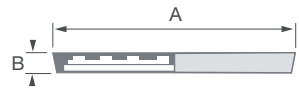

Gully Grid – Round

- For use in pedestrian areas only

Material: Aluminium

Cat No.	Dimensions (mm)	
	A	B
IG6	140	8
IG7	202	12
IG8	284	12



Gully Grid – Round

- For use in pedestrian areas only

Material: Cast Iron

Cat No.	Dimensions (mm)	
	A	B
IG6C	138	10
IG7C	202	10
IG8C	284	10

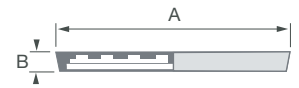

Dish Grid – Round

- For use in pedestrian areas only

Material: Cast Iron

Cat No.	Dimensions (mm)	
	A	B
IG11C	175	10



Hinged Grating and Frames – Square

- For use in pedestrian areas only

Material: Aluminium

Cat No.	Dimensions (mm)	
	A	B
IH1	120 x 120	25
IH2	150 x 150	25



Hinged Grating and Frames – Square

- For use in pedestrian areas only

Material: Cast Iron

Cat No.	Dimensions (mm)	
	A	B
IH2C	146 x 146	25
IH3C	229 x 229	25
IH4C	308 x 308	38



Hinged Grating and Frames – Round

- For use in pedestrian areas only

Material: Aluminium

Cat No.	Dimensions (mm)	
	A	B
IH6	193	23



Hinged Grating and Frames – Round

- For use in pedestrian areas only

Material: Cast Iron

Cat No.	Dimensions (mm)	
	A	B
IH7C	265	35

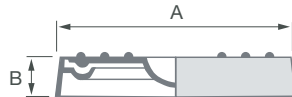

Cover Plate and Frame – Square

- For use in pedestrian areas only

Material: Aluminium

Cat No.	Dimensions (mm)	
	A	B
IS1	120 x 120	23
IS2	150 x 150	23
IS3	227 x 227	23



Cover Plate and Frame – Round

- For use in pedestrian areas only

Material: Aluminium

Cat No.	Dimensions (mm)	
	A	B
IS5	147	23
IS6	192	23
IS7	290	28

Channels

Product Details

Direction of Flow

- Direction of flow is from the socket towards the spigot
- **Important note:** Handing of socketed channel bends and junctions is viewed against the direction of flow

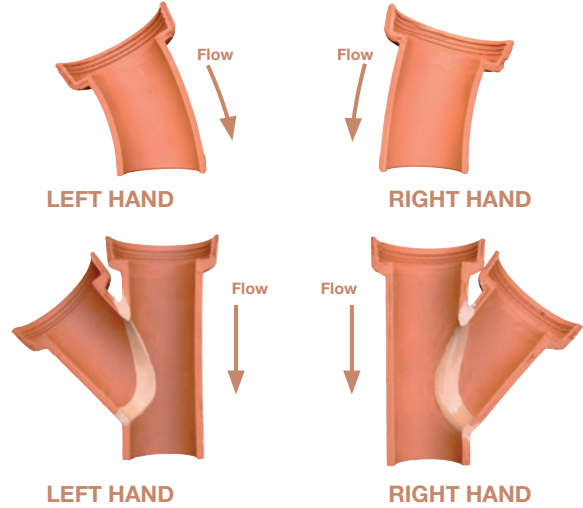

Pipe Plain Ended

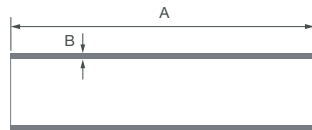
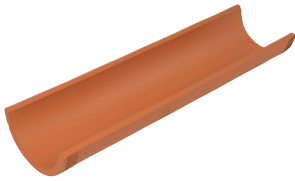

Channel Pipe

Material: Vitrified clay

Nominal Dia (mm)	Cat No.	Dimensions (mm)	
		A	B
100	CPP3/1	1000	11
150	CPP3/2	1000	14
225	CPP3/3	1000	23
300	CPP3/4	1000	36

Bends Plain Ended

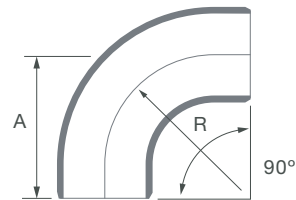

90° Bend

Material: Vitrified clay

Nominal Dia (mm)	Cat No.	Dimensions (mm)	
		A	R
100	CBP1/1	195	150
150	CBP1/2	285	230
225	VCB1/3	335	235
300	VCB1/4	470	320

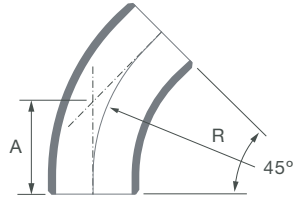

45° Bend

Material: Vitrified clay

Nominal Dia (mm)	Cat No.	Dimensions (mm)	
		A	R
100	CBP2/1	107	150
150	CBP2/2	150	230
225	VCB2/3	195	477
300	VCB2/4	286	682

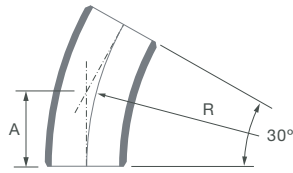

30° Bend

Material: Vitrified clay

Nominal Dia (mm)	Cat No.	Dimensions (mm)	
		A	R
100	CBP3/1	95	150
150	CBP3/2	117	230
225	VCB3/3	160	608
300	VCB3/4	230	880

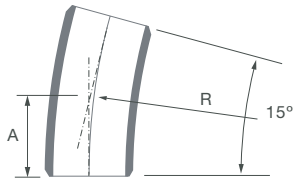

15° Bend

Material: Vitrified clay

Nominal Dia (mm)	Cat No.	Dimensions (mm)	
		A	R
100	CBP4/1	90	150
150	CBP4/2	100	230
225	VCB4/3	130	995
300	VCB4/4	195	1459

Junctions Plain Ended

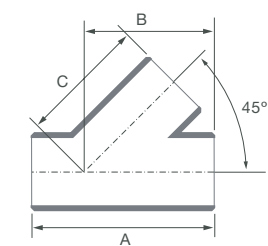

45° Oblique Junction – Left Hand

Material: Vitrified clay

Nominal Dia (mm)	Cat No.	Dimensions (mm)		
		A	B	C
100x100	CJP1/1L	405	235	225
150x100	CJP1/2L	405	300	300
150x150	CJP1/3L	485	330	340

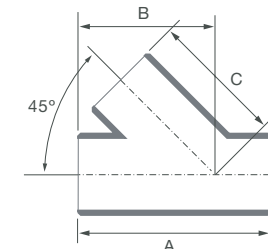
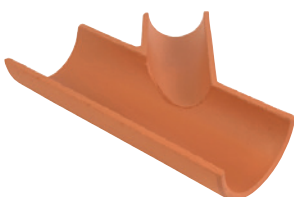

45° Oblique Junction – Right Hand

Material: Vitrified clay

Nominal Dia (mm)	Cat No.	Dimensions (mm)		
		A	B	C
100x100	CJP1/1R	405	235	225
150x100	CJP1/2R	405	300	300
150x150	CJP1/3R	485	330	340

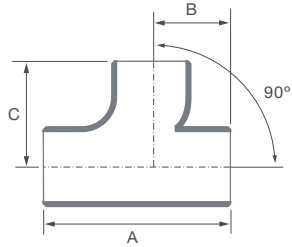
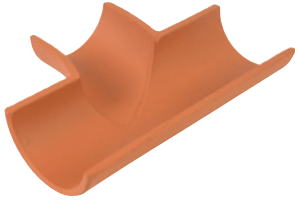

90° Curved Square Junction – Left Hand

Material: Vitrified clay

Nominal Dia (mm)	Cat No.	Dimensions (mm)		
		A	B	C
100x100	CJP2/1L	400	180	185
150x100	CJP2/2L	400	180	205
150x150	CJP2/3L	450	180	205

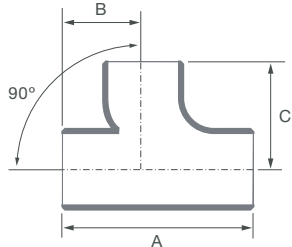
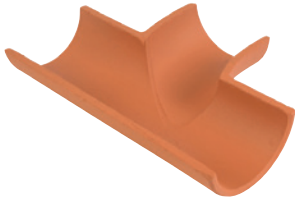

90° Curved Square Junction – Right Hand

Material: Vitrified clay

Nominal Dia (mm)	Cat No.	Dimensions (mm)		
		A	B	C
100x100	CJP2/1R	400	180	185
150x100	CJP2/2R	400	180	205
150x150	CJP2/3R	450	180	205

Fittings Plain Ended

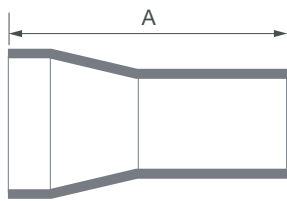

Enlarger

- Concentric enlarger

Material: Vitrified clay

Nominal Dia (mm)	Cat No.	Dimensions (mm)
		A
100x150	CTP1/1	260
225x300	VCTP4/3	550
300x400	CTP1/4	600

Pipe Socketed

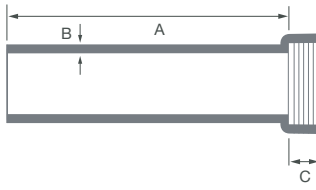
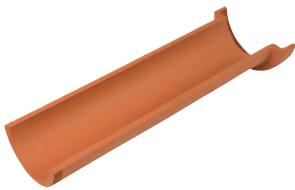

Channel Pipe

Material: Vitrified clay

Nominal Dia (mm)	Cat No.	Dimensions (mm)		
		A	B	C
100	CP4/1	900	16	60
150	CP4/2	900	21	60
225	CP4/3	900	23	70
300	CP3/4	1000	36	78

Fittings Socketed

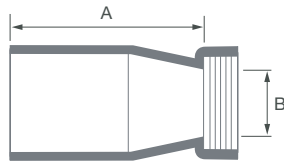

Enlarger

- Concentric enlarger

Material: Vitrified clay

Nominal Dia (mm)	Cat No.	Dimensions (mm)	
		A	B
100x150	CT2/1	300	100
150x225	CT2/2	450	150
225x300	CT2/3	600	225

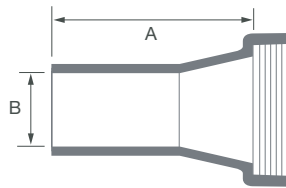

Reducer

- Concentric reducer

Material: Vitrified clay

Nominal Dia (mm)	Cat No.	Dimensions (mm)	
		A	B
150x100	CT1/1	300	100
225x150	CT1/2	450	150
300x225	CT1/3	600	225

Bends Socketed

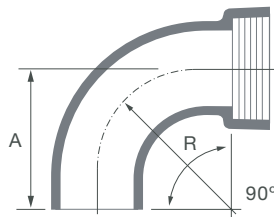

90° Bend

- To specify left or right hand, add L or R to the end of the Cat No.

Material: Vitrified clay

Nominal Dia (mm)	Cat No.	Dimensions (mm)	
		A	R
100	CB1/1	195	150
150	CB1/2	285	230
225	CB1/3	335	235
300	CB1/4	470	320

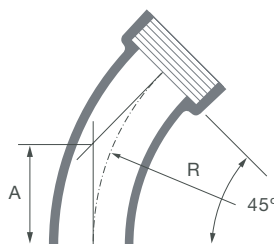

45° Bend

- To specify left or right hand, add L or R to the end of the Cat No.

Material: Vitrified clay

Nominal Dia (mm)	Cat No.	Dimensions (mm)	
		A	R
100	CB2/1	140	340
150	CB2/2	160	380
225	CB2/3	220	535
300	CB2/4	250	600

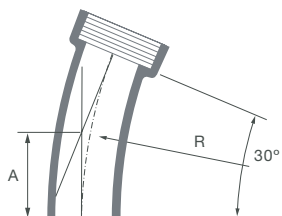

30° Bend

- To specify left or right hand, add L or R to the end of the Cat No.

Material: Vitrified clay

Nominal Dia (mm)	Cat No.	Dimensions (mm)	
		A	R
100	CB3/1	135	500
150	CB3/2	135	500
225	CB3/3	210	785
300	CB3/4	240	900

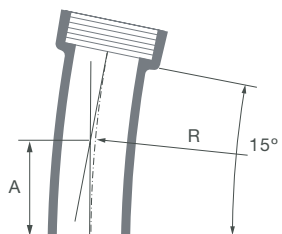

15° Bend

- To specify left or right hand, add L or R to the end of the Cat No.

Material: Vitrified clay

Nominal Dia (mm)	Cat No.	Dimensions (mm)	
		A	R
100	CB4/1	120	900
150	CB4/2	130	1000
225	CB4/3	210	1600
300	CB4/4	300	1730

Junctions Socketed

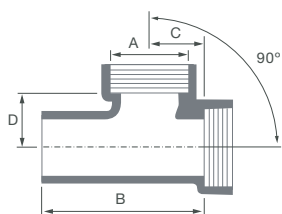

90° Square Junction

- To specify left or right hand, add L or R to the end of the Cat No.

Material: Vitrified clay

Nominal Dia (mm)	Cat No.	Dimensions (mm)			
		A	B	C	D
100x100	CJ2/1	100	300	100	100
150x100	CJ2/2	100	300	90	125
150x150	CJ2/3	150	455	180	195
225x100	CJ2/4	100	455	150	165
225x150	CJ2/5	150	455	180	260
225x225	CJ2/6	225	495	230	230

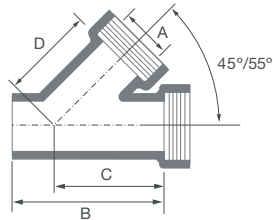

45°/55° Oblique Junction

- To specify left or right hand, add L or R to the end of the Cat No.

Material: Vitrified clay

Nominal Dia (mm)	Cat No.	Deg (°)	Dimensions (mm)			
			A	B	C	D
100x100	CJ1/1	45	100	300	100	100
150x100	CJ1/2	45	100	300	250	190
150x150	CJ1/3	45	150	455	290	280
225x100	CJ1/4	55	100	455	285	290
225x150	CJ1/5	55	150	455	310	320
225x225	CJ1/6	55	225	530	365	335
300x150	CJ1/8	55	150	455	370	370
300x225	CJ1/9	55	225	610	420	400
300x300	CJ1/10	55	300	710	480	450

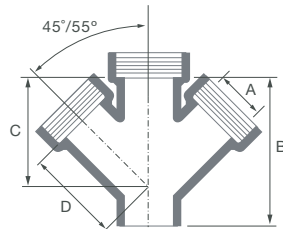

45°/55° Double Oblique Junction

Material: Vitrified clay

Nominal Dia (mm)	Cat No.	Deg (°)	Dimensions (mm)			
			A	B	C	D
100x100	CJ3/1	45	100	300	230	190
150x100	CJ3/2	45	100	300	250	240
150x150	CJ3/3	45	150	455	345	325
225x150	CJ3/5	55	150	455	295	320
225x225	CJ3/6	55	225	525	370	340
300x150	CJ3/8	55	150	450	370	380
300x225	CJ3/9	55	225	600	420	420

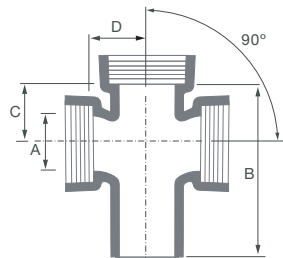

90° Double Square Junction

Material: Vitrified clay

Nominal Dia (mm)	Cat No.	Dimensions (mm)			
		A	B	C	D
100x100	CJ4/1	100	300	100	100
150x150	CJ4/3	150	455	260	200
225x225	CJ4/6	225	530	210	230

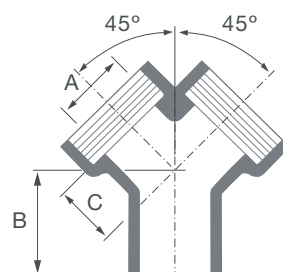

45° Breeches Oblique Junction

Material: Vitrified clay

Nominal Dia (mm)	Cat No.	Dimensions (mm)		
		A	B	C
100x100	CJ5/1	100	150	90
150x100	CJ5/2	100	240	115
150x150	CJ5/3	150	250	180
225x150	CJ5/5	150	440	180
225x225	CJ5/6	225	355	210
300x225	CJ5/9	225	335	260
300x300	CJ5/10	300	320	280

See page 127 for branch channel selector

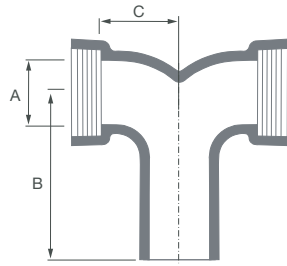

90° Breeches Curved Square Junction

- CJ6/6 and CJ6/10 are square junctions

Material: Vitrified clay

Nominal Dia (mm)	Cat No.	Dimensions (mm)		
		A	B	C
150x150	CJ6/3	150	385	205
225x150	CJ6/5	150	585	230
225x225	CJ6/6	225	420	260

Branch 1/2 Section

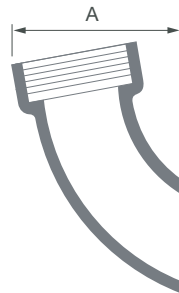

10° Bend

- To specify left or right hand, add L or R to the end of the Cat No.

Material: Vitrified clay

Nominal Dia (mm)	Cat No.	Dimensions (mm)
		A
100	CX1/1	250
150	CX2/1	280

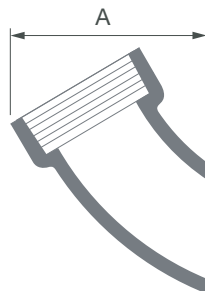

30° Bend

- To specify left or right hand, add L or R to the end of the Cat No.

Material: Vitrified clay

Nominal Dia (mm)	Cat No.	Dimensions (mm)
		A
100	CX1/2	250
150	CX2/2	280

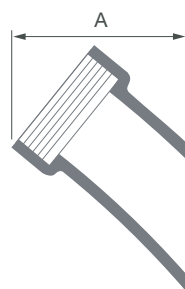

50° Bend

- To specify left or right hand, add L or R to the end of the Cat No.

Material: Vitrified clay

Nominal Dia (mm)	Cat No.	Dimensions (mm)
		A
100	CX1/3	250
150	CX2/3	280

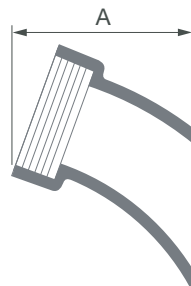

70° Bend

- To specify left or right hand, add L or R to the end of the Cat No.

Material: Vitrified clay

Nominal Dia (mm)	Cat No.	Dimensions (mm)
		A
100	CX1/4	250
150	CX2/4	280

See page 127 for branch channel selector

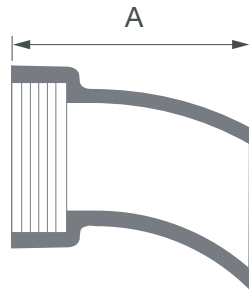

90° Bend

- To specify left or right hand, add L or R to the end of the Cat No.

Material: Vitrified clay

Nominal Dia (mm)	Cat No.	Dimensions (mm)	
		A	
100	CX1/5	250	
150	CX2/5	280	

Branch 3/4 Section

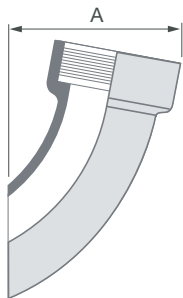

10° Bend

- To specify left or right hand, add L or R to the end of the Cat No.

Material: Vitrified clay

Nominal Dia (mm)	Cat No.	Dimensions (mm)	
		A	
100	CX1A	225	
150	CX2A	280	

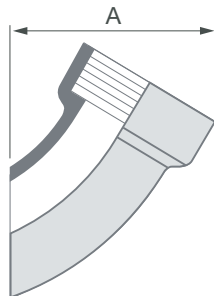

30° Bend

- To specify left or right hand, add L or R to the end of the Cat No.

Material: Vitrified clay

Nominal Dia (mm)	Cat No.	Dimensions (mm)	
		A	
100	CX1B	250	
150	CX2B	280	

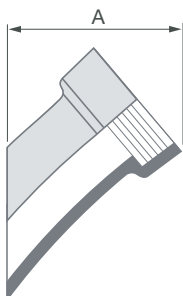

50° Bend

- To specify left or right hand, add L or R to the end of the Cat No.

Material: Vitrified clay

Nominal Dia (mm)	Cat No.	Dimensions (mm)	
		A	
100	CX1C	225	
150	CX2C	280	

See page 127 for branch channel selector

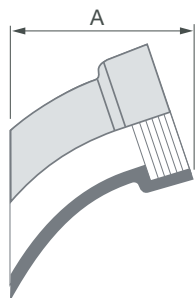

70° Bend

- To specify left or right hand, add L or R to the end of the Cat No.

Material: Vitrified clay

Nominal Dia (mm)	Cat No.	Dimensions (mm)
		A
100	CX1D	225
150	CX2D	280

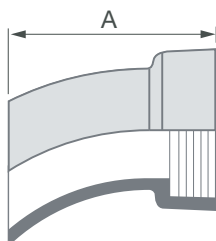

90° Bend

- To specify left or right hand, add L or R to the end of the Cat No.

Material: Vitrified clay

Nominal Dia (mm)	Cat No.	Dimensions (mm)
		A
100	CX1E	225
150	CX2E	280

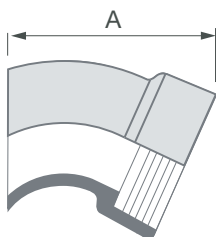

115° Bend

- To specify left or right hand, add L or R to the end of the Cat No.

Material: Vitrified clay

Nominal Dia (mm)	Cat No.	Dimensions (mm)
		A
100	CX1F	225
150	CX2F	280

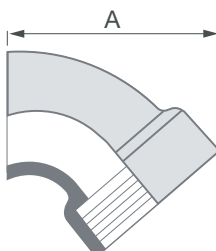

140° Bend

- To specify left or right hand, add L or R to the end of the Cat No.

Material: Vitrified clay

Nominal Dia (mm)	Cat No.	Dimensions (mm)
		A
100	CX1G	225
150	CX2G	280

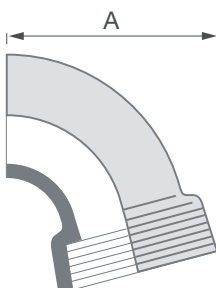
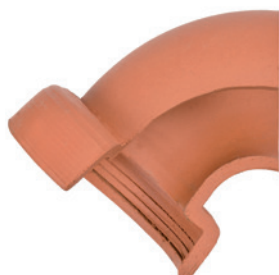

165° Bend

- To specify left or right hand, add L or R to the end of the Cat No.

Material: Vitrified clay

Nominal Dia (mm)	Cat No.	Dimensions (mm)
		A
100	CX1H	225
150	CX2H	280

Yard / Road Gullies

Product Details

Yard Gullies

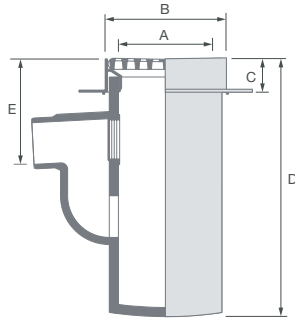

Yard Gully Complete with A15 Grating and Frame

- All yard gullies are trapped and roddable
- Grating is hinged and secured with two screws
- A15 grating and frame suitable for pedestrian and domestic areas

Material: Vitrified clay

Nominal Dia (mm)	Cat No.	Certs.	Dimensions (mm)		
			A	B	C
100	RGP5	☐ CE	225	290	75
150	RGP7	☐ CE	225	290	75
			D	E	
			620	250	
			620	300	

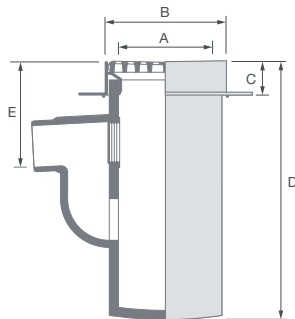

Yard Gully Complete with B125 Grating and Frame

- Grating is hinged and secured with two screws
- B125 grating and frame suitable for pedestrian areas and car parks restricted to private cars

Material: Vitrified clay

Nominal Dia (mm)	Cat No.	Certs.	Dimensions (mm)		
			A	B	C
100	RGP6	☐ CE	225	290	75
150	RGP8	☐ CE	225	290	75
			D	E	
			620	250	
			620	300	

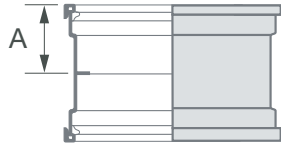

Yard Gully Extras



Coupling

- Used to connect the raising piece to the gully

Material: Polypropylene

Nominal Dia (mm)	Cat No.	Certs.	Dimensions (mm)	
			A	
225	SC1/5	 	75	

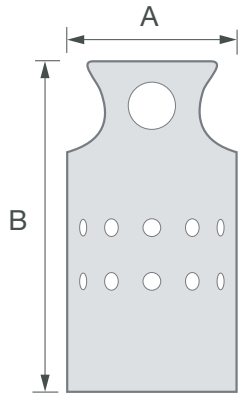

Combined Filter and Silt Bucket

- For use with all yard gullies



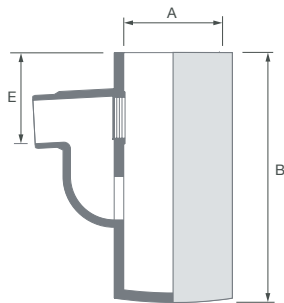

Material: Plastic

Nominal Dia (mm)	Cat No.	Certs.	Dimensions (mm)	
			A	B
–	IBP3		205	400



Yard Gully

Material: Vitrified clay

Nominal Dia (mm)	Cat No.	Certs.	Dimensions (mm)		
			A	B	C
100	RGP1	 	225	575	210
150	RGP2	 	225	575	270



Grating and Frame

- RGP3 – Loading Class A15 Grating and Frame
- RGP4 – Loading Class B125 Grating and Frame

Material: Ductile iron / Polypropylene

Nominal Dia (mm)	Cat No.
–	RGP3
–	RGP4



Spare Stopper

Material: EPDM

Nominal Dia (mm)	Cat No.
100	RSG2

Road Gullies

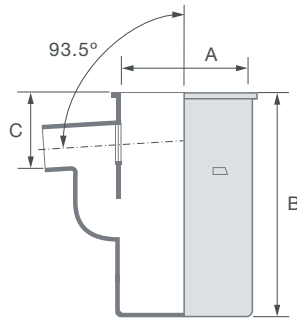

Clay Road Gully

- All road gullies are trapped and roddable

Material: Vitrified clay

Nominal Dia (mm)	Cat No.	Certs.	Dimensions (mm)		
			A	B	C
100	RGR1	CE	300	600	200
150	RGR2	CE	300	600	250
150	RGR3	CE	400	750	250
150	RGR4	CE	450	900	250



Spare Stopper

Material: Polypropylene

Nominal Dia (mm)	Cat No.
100	RSG1

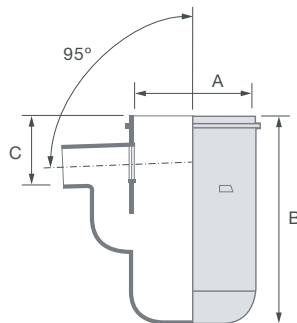

Plastic Road Gully

- Trapped and roddable gully
- Outlet gives direct connection to a 150mm SuperSleve coupling

Material: Vitrified clay

Nominal Dia (mm)	Cat No.	Certs.	Dimensions (mm)		
			A	B	C
150	MGP2/2		375	750	250

Unjointed

Product Details

Pipes

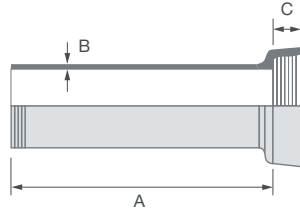
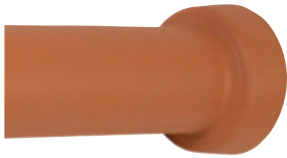

Socketed Pipe

- Traditional system of spigot and socket pipe for cement mortar jointing

Material: Vitrified clay

Nominal Dia (mm)	Cat No.	Certs.	Dimensions (mm)		
			A	B	C
100	RP1		1000	15	50
150	RP100/2		1000	21	55
225	RP100/3		1000	23	65

Fittings

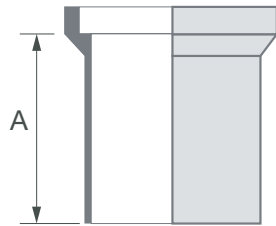

Square Raising Piece

- 150mm raising pieces are for use with SG2/1 SG2/2 gullies and SH1 and SH2 hoppers

Material: Vitrified clay

Nominal Dia (mm)	Cat No.	Certs.	Dimensions (mm)
			A
150x150	RRS2/1		75
150x150	RRS2/2		150
150x150	RRS2/3		225
150x150	RRS2/4		300
225x225	RRS3/1		75
225x225	RRS3/2		150

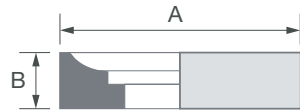

Dish Top

Material: Vitrified clay

Nominal Dia (mm)	Cat No.	Certs.	Dimensions (mm)	
			A	B
100	RDR2		250x250	145
150	RDR3		300x300	145

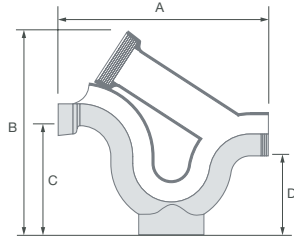

Interceptor – Winsor

- Due to manufacturing processes, all dimensions on interceptors have wide tolerances
- 225mm interceptors are manufactured segmentally from straight pipe
- Complete with stopper
- For use on the downstream side of a manhole

Material: Vitrified clay

Nominal Dia (mm)	Cat No.	Certs.	Dimensions (mm)	
			A	B
100	RI1/1		620	525
150	RI1/2		760	540
225	RI1/3		1060	750
			C	D
			255	200
			255	200
			300	285

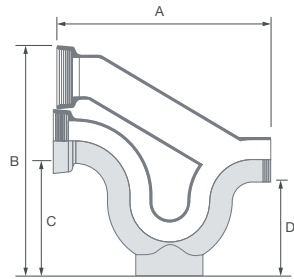

Interceptor – Kenon

- Due to manufacturing processes, all dimensions on interceptors have wide tolerances
- Complete with stopper
- For use on the downstream side of a manhole

Material: Vitrified clay

Nominal Dia (mm)	Cat No.	Certs.	Dimensions (mm)	
			A	B
100	RI2/1		650	575
150	RI2/2		760	756
			C	D
			250	215
			347	288

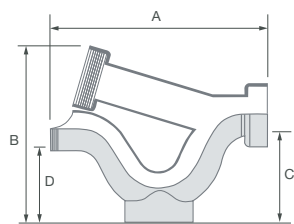

Interceptor – Reverse Action

- Due to manufacturing processes, all dimensions on interceptors have wide tolerances
- Complete with stopper
- For use on the upstream side of a manhole

Material: Vitrified clay

Nominal Dia (mm)	Cat No.	Certs.	Dimensions (mm)	
			A	B
100	RI3/1		645	490
150	RI3/2		840	630
			C	D
			245	210
			335	270

HepLine

Product Details

Pipes



Perforated – Plain Ended

- 100 and 150mm HepLine pipes are jointed with standard couplings from the SuperSleve range
- Stoppers and fittings for all HepLine pipe sizes are available from the SuperSleve range

Material: Vitrified clay

Nominal Dia (mm)	Cat No.	Certs.		Dimensions (mm)	
				A	B
100	LP1		CE	1600	11
150	LP2		CE	1750	14



Perforated – Socketed

- Stoppers and fittings for all HepLine pipe sizes are available from the SuperSleve range

Material: Vitrified clay

Nominal Dia (mm)	Cat No.	Certs.		Dimensions (mm)	
				A	B
225	LP3		CE	2000	19
300	LP200/4		CE	2000	29

HepLine Data

Cat No.	Nominal Dia. (mm)	Length of Pipe (mm)	Rows of Holes	Holes per Row	Nominal Hole Dia. (mm)	Area of Perforations (mm ² /pipe)	Area of Perforations (mm ² /m)
LP1	100	1600	2	15	8	1508	943
LP2	150	1750	4	15	8	3016	1724
LP3	225	2000	4	16	8	4022	2011
LP200/4	300	2000	6	23	8	6938	3469

Accessories

Product Details

Clayware Accessories

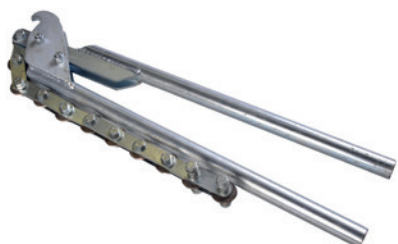

Pipe Cutter – Lever

- MPC1 cuts 100mm SuperSleve
- MPC2 cuts 100 and 150mm SuperSleve

Material: Metal

Nominal Dia (mm)	Cat No.
100	MPC1
100 & 150	MPC2



Pipe Trimmer

- For use with 100 and 150mm SuperSleve pipe

Material: Metal

Nominal Dia (mm)	Cat No.
100 & 150	MPT1

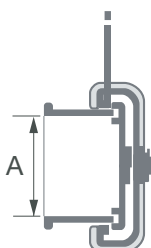

Lever Locking Stopper

- Cement mortar jointed into a socket adaptor. SA1/1 for 100mm, SA1/2 for 150mm

Material: Metal

Nominal Dia (mm)	Cat No.	Dimensions (mm)
		A
100	IL1	140
150	IL2	190



Lubricant

- Lubricant is specified as non-hazardous and should be handled according to good industrial hygiene practice
- SL1C is a high performance lubricant recommended for nitrile seals, cold and/or wet weather

Nominal Dia (mm)	Cat No.
1 kilo	SL1
2.5 kilo	SL2
1 kilo	SL1C

Inspection Chambers

Product Summary

Introduction – Mini Access Chamber (MAC)

Description

300mm diameter polypropylene inspection chamber for private drainage applications.

- Complete unit including base unit, 2 raising pieces and cover and frame
- Raising piece may be cut to length to achieve required invert depth

Applications

- For above ground access and maintenance inspection of buried pipework up to 0.6 metres deep
- Loading class A15 (15kN). Suitable for use in pedestrian areas

Key Dimensions

- Internal diameter: 300mm
- Inlets/outlets: 100mm

Key Features & Benefits

- Fast, easy installation: no wet trades
- Lightweight: no lifting equipment required
- Raising piece can be cut to required length
- The main channel invert level is 50mm below the side branch invert level

Compliance

Building Regulations – Section H1:
Shallow only, to maximum depth 0.6m.



Mini Access Chamber (MAC)

Product Details

Access Chamber

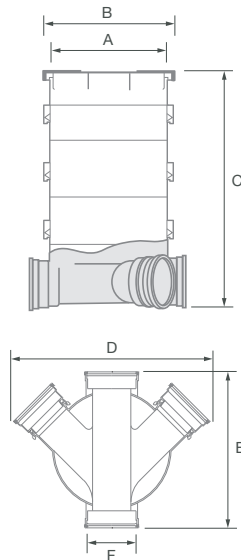

Mini Access Chamber – MAC

- 300mm diameter chamber, supplied with 2 inlet stoppers
- 600mm deep, with 100mm straight through main channel and 2 x 45° branch inlets
- Complete unit including base unit, two raising pieces with cover and frame
- The main channel invert level is 50mm below the side branch invert level
- Conversion adaptors to 110mm plastic pipe supplied

Material: Polypropylene

Nominal Dia (mm)	Cat No.	Dimensions (mm)		
		A	B	C
100	SDAC1/1	300	346	600
		D	E	F
		510	405	100

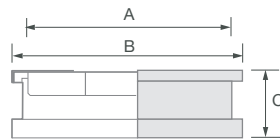

Cover and Frame – Airtight

- Cover is secured with four screws and incorporates an airtight seal making it suitable for use indoors
- Loading class A15 (15kN). Suitable for use in pedestrian areas

Material: Polypropylene

Nominal Dia (mm)	Cat No.	Dimensions (mm)		
		A	B	C
–	SDC3	300	346	85

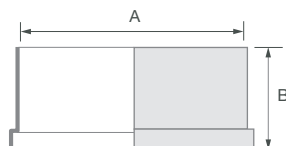

Raising Piece

- Raising piece with rubber sealing ring
- Effective height 150mm
- Final shaft section can be cut to length

Material: Polypropylene

Nominal Dia (mm)	Cat No.	Dimensions (mm)	
		A	B
300	SDC4	300	150

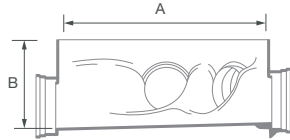

Base Unit

- 215mm deep, with 100mm straight through main channel and 2 x 45° branch inlets
- The main channel invert level is 50mm below the side branch invert level
- Conversion adaptors to 110mm plastic pipe and 2no. inlet stoppers supplied

Material: Polypropylene

Nominal Dia (mm)	Cat No.	Dimensions (mm)	
		A	B
300	SDC5	300	215



Spare Screws for Cover and Frame

- For use with SDC3 cover and frame

Material: Aluminium

Nominal Dia (mm)	Cat No.
–	SKW1

Inspection Chambers

Product Summary

Introduction – Polypropylene Inspection Chamber (PPIC)

Description

475mm diameter polypropylene inspection chamber for private drainage applications.

Available in three depths:

- 595mm and 940mm deep chambers with 100mm straight through main channel with 2 x 100mm branches at 90° and 2 x 100mm branches at 45°
- 1030mm deep chamber with 150mm straight through main channel with 2 x 150mm branches at 90° and 2 x 100mm branches at 45°

Raising piece may be cut to length to achieve the required invert depth.

Applications

- For above ground access and maintenance inspection of buried pipework up to 1.2 metres deep
- Loading class A15 (15kN). Suitable for use in pedestrian areas. (Tested at 35kN test load)
- Loading class B125 (125kN). Suitable for use in car parks restricted to private cars

Key Dimensions

- Height of chamber:
 - 595mm and 940mm (for 100mm system)
 - 1030mm (for 150mm system)
- Internal diameter: 475mm
- Additional raising piece height: 175mm
- Maximum installation depth 1.2 metres

Key Features & Benefits

- Fast, easy installation: no wet trades
- Lightweight: no lifting equipment required
- Chamber depth can be increased (up to a maximum depth of 1.2m) using additional raising piece and sealing ring
- Raising piece can be cut to required length
- For the 100mm base the main channel invert level is 50mm below the side branch invert level
- For the 150mm base the main channel invert level is 75mm below the side branch invert level

Compliance

Building Regulations – Section H1: Shallow only, to maximum depth 1.2m.



Polypropylene Inspection Chamber (PPIC)

Product Details

Inspection Chambers

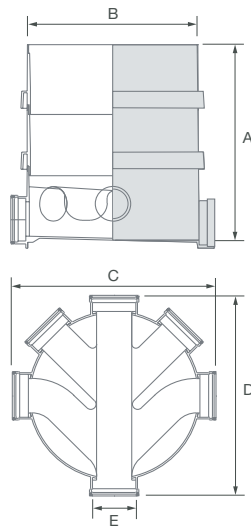

100/110 Polypropylene Inspection Chamber – PPIC

- 475mm diameter chamber, supplied with 4 inlet stoppers
- 595mm deep, with 100mm straight through main channel with 2 x 90° and 2 x 45° branch inlets
- The main channel invert level is 50mm below the side branch invert level
- Conversion adaptors to 110mm plastic pipe supplied

Material: Polypropylene

Nominal Dia (mm)	Cat No.	Dimensions (mm)		
		A	B	C
100	SPIC2/1	595	475	582
		D	E	
		582	100	

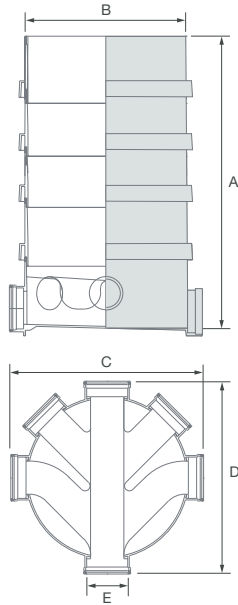

100/110 Polypropylene Inspection Chamber – PPIC

- 475mm diameter chamber, supplied with 4 inlet stoppers
- 940mm deep, with 100mm straight through main channel with 2 x 90° and 2 x 45° branch inlets
- The main channel invert level is 50mm below the side branch invert level
- Conversion adaptors to 110mm plastic pipe supplied

Material: Polypropylene

Nominal Dia (mm)	Cat No.	Dimensions (mm)		
		A	B	C
100	SPIC1/1	940	475	582
		D	E	
		582	100	

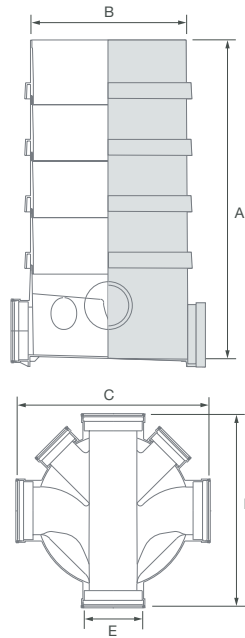

Mixed Base Polypropylene Inspection Chamber – PPIC

- 475mm diameter chamber, supplied with 4 inlet stoppers
- 1030mm deep, with 150mm straight through main channel with 2 x 150mm 90° branches and 2 x 100mm 45° branches
- The main channel invert level is 75mm below the side branch invert level
- Conversion adaptors to 110mm and 160mm plastic pipe supplied

Material: Polypropylene

Nominal Dia (mm)	Cat No.	Dimensions (mm)		
		A	B	C
100/150	SPIC1/2	1030	475	610
		D	E	
		610	150	

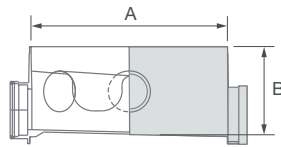

PPIC Base

- 475mm diameter chamber, supplied with 4 inlet stoppers
- 210mm deep, with 100mm straight through main channel with 2 x 90° and 2 x 45° branch inlets
- The main channel invert level is 50mm below the side branch invert level
- Conversion adaptors to 110mm plastic pipe supplied

Material: Polypropylene

Nominal Dia (mm)	Cat No.	Dimensions (mm)	
		A	B
100	SPIC6/1	475	210

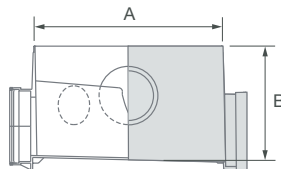

Mixed PPIC Base

- 475mm diameter chamber, supplied with 4 inlet stoppers
- 300mm deep, with 150mm straight through main channel with 2 x 150mm 90° branches and 2 x 100mm 45° branches
- The main channel invert level is 75mm below the side branch invert level
- Conversion adaptors to 110mm and 160mm plastic pipe supplied

Material: Polypropylene

Nominal Dia (mm)	Cat No.	Dimensions (mm)	
		A	B
100/150	SPIC6/2	475	300



Raising Piece

- For use with all polypropylene inspection chambers and PPIC bases
- Effective height 175mm
- Final shaft section can be cut to length

Material: Polypropylene

Nominal Dia (mm)	Cat No.	Dimensions (mm)	
		A	B
475	SPIC4	475	175



Sealing Ring for Raising Piece

- For use with SPIC4 raising piece

Material: Rubber

Nominal Dia (mm)	Cat No.	Dimensions (mm)
		A
475	SPIC5	475

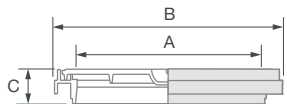

Round Ductile Iron Cover and Plastic Frame

- Includes security clips to secure the frame to the chamber
- Loading class A15 (15kN). Tested at 35kN test load

Material: Ductile Iron

Nominal Dia (mm)	Cat No.	Dimensions (mm)		
		A	B	C
–	SPK8	440	535	35

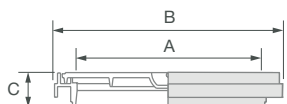

Round Ductile Iron Cover and Plastic Frame

- Includes security clips to secure the frame to the chamber
- Loading class B125 (125kN)

Material: Ductile Iron

Nominal Dia (mm)	Cat No.	Dimensions (mm)		
		A	B	C
–	SPK9	440	535	35

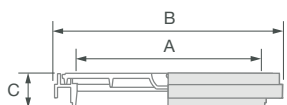

Round Composite Cover and Plastic Frame

- Includes security clips to secure the frame to the chamber
- Loading class A15 (15kN). Tested at 35kN test load

Material: Composite

Nominal Dia (mm)	Cat No.	Dimensions (mm)		
		A	B	C
–	SPK10	440	535	35

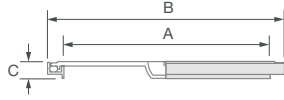
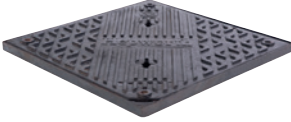

Square Ductile Iron Cover and Frame – Airtight

- Includes security clips to secure the frame to the chamber
- Loading class A15 (15kN). Tested at 35kN test load
- Cover is secured with four screws and incorporates an airtight seal making it suitable for use indoors

Material: Ductile Iron

Nominal Dia (mm)	Cat No.	Dimensions (mm)		
		A	B	C
–	SPKS8	440	525x525	25



Inlet Adaptor

- 150mm to 100mm SuperSleeve reducer

Material: Polypropylene

Nominal Dia (mm)	Cat No.	Dimensions (mm)
		A
150/100	SPIC7	55



Extra Stopper

- For use with all 100mm base inlets

Material: Polypropylene

Nominal Dia (mm)	Cat No.
100	UGS



Extra Stopper

- For use with all 150mm base inlets

Material: Polypropylene

Nominal Dia (mm)	Cat No.
150	UYS



Extra Conversion Adaptor

- Used to convert 100mm SuperSleeve inlet to 110mm plastic

Material: Polypropylene

Nominal Dia (mm)	Cat No.
100	M09H BL



Extra Conversion Adaptor

- Used to convert 150mm SuperSleve inlet to 160mm plastic

Material: Polypropylene

Nominal Dia (mm)	Cat No.
150	M09J BL



Spare Security Clips for SPK8 & SPK9

- Used to secure the frame to the chamber

Material: Steel

Nominal Dia (mm)	Cat No.
–	SPK8+9CLIP



Spare Frame for SPK8, SPK9 & SPK10

Material: Polypropylene

Nominal Dia (mm)	Cat No.
–	UCIF



Spare Screws for SPK8

Material: Aluminium

Nominal Dia (mm)	Cat No.
–	SKW3

Inspection Chambers

Product Summary

Introduction – Range 450

Description

450mm diameter polypropylene inspection chamber for adoptable and private drainage applications. Compliant with Ofwat's Code for Adoptable Sewers – Appendix C, Design Construction Guidance.

- Choice of eight bases for equal and unequal pipe connections
- Dedicated bases for use directly with 100/150mm clay pipework
- 450mm diameter shaft may be cut to length to achieve required invert up to maximum 3 metres
- Restriction access cap to be used when installing deeper than 1m in adoptable or 1.2m in private drainage

Applications

- For above ground access and maintenance inspection of buried pipework up to 3 metres deep
- Loading class A15 (15kN). Suitable for use in pedestrian areas
- Loading class B125 (125kN). Suitable for use in car parks restricted to private cars*
- Loading class D400 (400kN). Suitable for use in areas where cars and lorries have access*

*With cover & frame supported by concrete plinth

NOTE: Concrete plinth not required for non-loaded applications such as domestic gardens

Key Dimensions

- External shaft diameter: 515mm
- Shaft length: 3m
- Maximum installation depth: 3m

Key Features & Benefits

- Full range of dedicated bases, ensure that smooth flow can be achieved
- Quick & easy to install, with a sculptured neck on the base, which allows the shaft to be fitted with little effort
- Lightweight polypropylene chamber bases, no lifting equipment required
- 3m shaft can be cut to required length

Compliance

Range 450 chambers comply with the following standards and regulations.

- BS EN 13598-2 
- Design for Construction Guidance – Type D: (Non-entry). Maximum depth from cover level to soffit of pipe: 3m
- Building Regulations – Section H1



Range 450 Inspection Chamber

Product Details

Bases (100mm)

Range 450 bases for use with 100mm SuperSleve pipe – supplied with a base to shaft sealing ring.

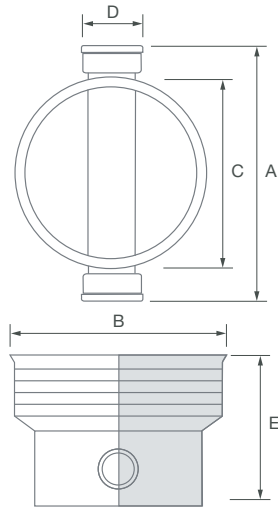

Equal Inspection Chamber Base

- 450mm diameter base incorporating straight through channel

Material: Polypropylene

Nominal Dia (mm)	Cat No.	Certs.	Dimensions (mm)		
			A	B	C
100	44NE310		614	570	500
			D	E	
			100	501	

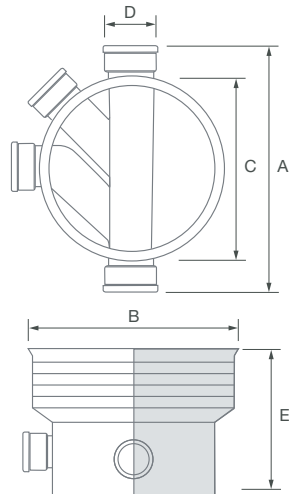

Equal Inspection Chamber Base

- 450mm diameter base incorporating straight through channel with 1 x 90° and 1 x 45° left hand branch inlets
- Supplied with 1 x 100mm inlet stopper
- Step height for side connection = 50mm

Material: Polypropylene

Nominal Dia (mm)	Cat No.	Certs.	Dimensions (mm)		
			A	B	C
100	44NE314		614	570	500
			D	E	
			100	501	

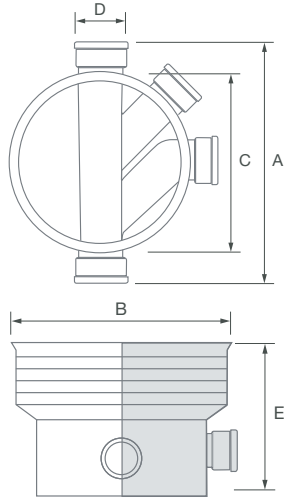

Equal Inspection Chamber Base

- 450mm diameter base incorporating straight through channel with 1 x 90° and 1 x 45° right hand branch inlets
- Supplied with 1 x 100mm inlet stopper
- Step height for side connection = 50mm

Material: Polypropylene

Nominal Dia (mm)	Cat No.	Certs.	Dimensions (mm)		
			A	B	C
100	44NE315		614	570	500
			D	E	
			100	501	

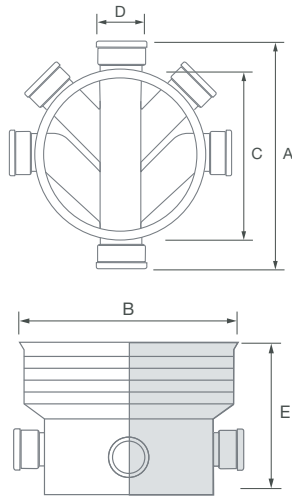

Equal Inspection Chamber Base

- 450mm diameter base incorporating straight through channel with 2 x 90° and 2 x 45° left / right hand branch inlets
- Supplied with 3 x 100mm inlet stopper
- Step height for side connection = 50mm

Material: Polypropylene

Nominal Dia (mm)	Cat No.	Certs.	Dimensions (mm)		
			A	B	C
100	44NE316		614	570	500
			D	E	
			100	501	

Bases (150mm)

Range 450 bases for use with 150mm SuperSleve pipe – supplied with a base to shaft sealing ring.

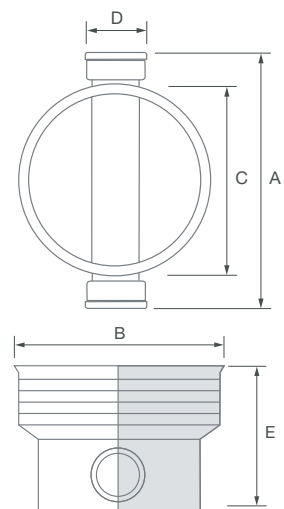

Equal Inspection Chamber Base

- 450mm diameter base incorporating straight through channel

Material: Polypropylene

Nominal Dia (mm)	Cat No.	Certs.	Dimensions (mm)		
			A	B	C
150	46NE310		644	570	500
			D	E	
			150	501	

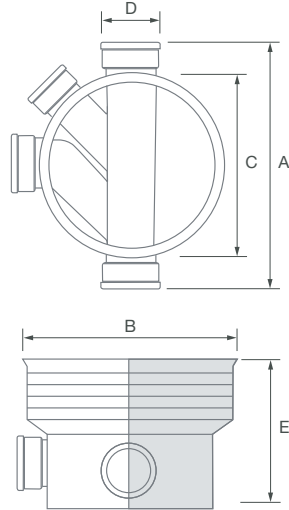

Unequal Inspection Chamber Base

- 450mm diameter base incorporating 150mm straight through channel with 1 x 150mm 90° and 1 x 100mm 45° left hand branch inlets
- Supplied with 1 x 100mm inlet stopper
- Step height for 100mm side connection = 50mm
- Step height for 150mm side connection = 70mm

Material: Polypropylene

Nominal Dia (mm)	Cat No.	Certs.	Dimensions (mm)		
			A	B	C
150	46NE317		644	570	500
			D	E	
			150	501	

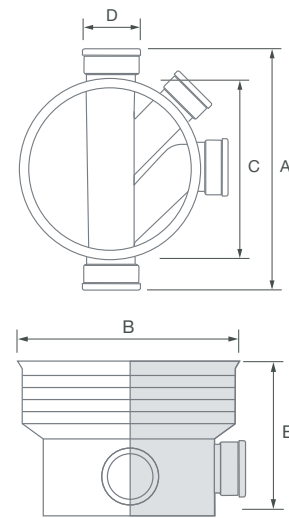

Unequal Inspection Chamber Base

- 450mm diameter base incorporating 150mm straight through channel with 1 x 150mm 90° and 1 x 100mm 45° right hand branch inlets
- Supplied with 1 x 100mm inlet stopper
- Step height for 100mm side connection = 50mm
- Step height for 150mm side connection = 70mm

Material: Polypropylene

Nominal Dia (mm)	Cat No.	Certs.	Dimensions (mm)		
			A	B	C
150	46NE318		644	570	500
			D	E	
			150	501	

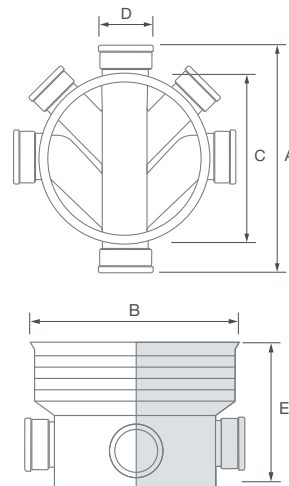

Unequal Inspection Chamber Base

- 450mm diameter base incorporating 150mm straight through channel with 2 x 150mm 90° and 2 x 100mm 45° left / right hand branch inlets
- Supplied with 1 x 150mm and 2 x 100mm inlet stopper
- Step height for 100mm side connection = 50mm
- Step height for 150mm side connection = 70mm

Material: Polypropylene

Nominal Dia (mm)	Cat No.	Certs.	Dimensions (mm)		
			A	B	C
150	46NE319		644	570	500
			D	E	
			150	501	

Shaft

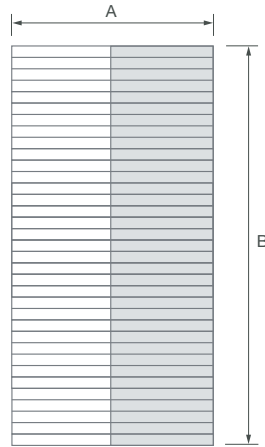

Inspection Chamber Shaft

- 450mm dia. plain-ended corrugated shaft
- Length: 3 metres
- Can be cut to length to achieve required invert depth
- For use with all Range 450 bases

Material: Polypropylene

Nominal Dia (mm)	Cat No.	Dimensions (mm)	
		A	B
450	40NE300	515	3000*

*Dimension B = effective height

Cap

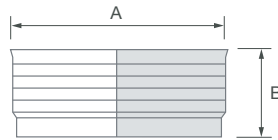

Restriction Access Cap

- For use with 40NE300 shaft
- Restricts access to 350mm diameter
- Supplied with one 450mm sealing ring

Material: Polypropylene

Nominal Dia (mm)	Cat No.	Dimensions (mm)	
		A	B
450	40NE930	577	265

Spares

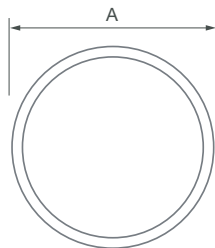
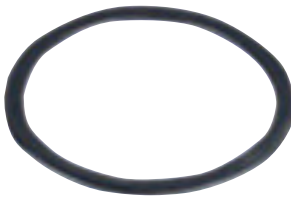

Chamber Base to Shaft Seal

- 450mm diameter for use with 40NE300 – at foot of shaft

Material: EPDM

Nominal Dia (mm)	Cat No.	Dimensions (mm)
		A
–	450TW117	450

Connection Kits



Backdrop Connector Kit – 100mm

- For connecting 100mm SuperSleve pipe to Range 450 and Range 600 shaft sections where a backdrop connection is required
- Use the following component, along with the SA15/1 adaptor

Material: PVC-U

Nominal Dia (mm)	Cat No.
110	NE950



Backdrop Connector Kit – 150mm

- For connecting 150mm SuperSleve pipe to Range 450 and Range 600 IC shaft sections where a backdrop connection is required
- Use the following component, along with the SA15/2 adaptor

Material: PVC-U

Nominal Dia (mm)	Cat No.
160	NE960

Inspection Chambers

Product Summary

Introduction – Range 600

Description

600mm diameter polypropylene inspection chamber for adoptable and private drainage applications. Compliant with Ofwat's Code for Adoptable Sewers – Appendix C, Design Construction Guidance.

- Choice of twelve bases for equal pipe connections
- For use with 150mm, 225mm and 300mm Hepworth SuperSleve pipework via the appropriate adaptor
- 600mm diameter shaft may be cut to length to achieve required invert down to a maximum of 3m
- Restriction access cap to be used when installing deeper than 1m in adoptable or 1.2m in private drainage

Applications

- For above ground access and maintenance inspection of buried pipework down to 3 metres deep
- Loading class A15 (15kN). Suitable for use in pedestrian areas
- Loading class B125 (125kN). Suitable for use in car parks restricted to private cars*
- Loading class D400 (400kN). Suitable for use in areas where cars and lorries have access*

*With cover & frame supported by concrete plinth

Key Dimensions

- Invert depth of base:
 - 646mm [for 150mm system]
 - 705mm [for 225mm and 300mm systems]
- External shaft diameter: 683mm
- Shaft length: 3m
- Maximum installation depth: 3m

Key Features & Benefits

- Fast, easy installation: no wet trades
- Lightweight: no lifting equipment required
- Reinforced base plate to withstand groundwater pressure
- Shaft can be cut to required length
- All inlets and outlet sockets allow $\leq 7.5^\circ$ movement in all directions

Compliance

Range 600 chambers comply with the following standards and regulations

- BS EN 13598-2 
- Design for Construction Guidance – Type D: (Non-entry). Maximum depth from cover level to soffit of pipe: 3m
- Building Regulations – Section H1



Range 600 Inspection Chamber

Product Details

Bases

All Range 600 bases are supplied with a base-to shaft sealing ring.

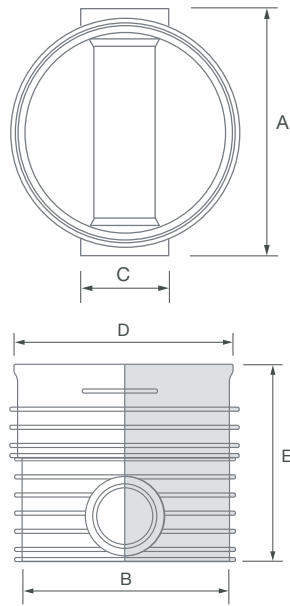

Equal Inspection Chamber Base

- 600mm diameter base incorporating straight through channel
- To connect 150mm, 225mm and 300mm SuperSleve use adaptors TA/2 (with 150 base), TA/4 (with 225 base) and TA/7 (with 300 base)

Material: Polypropylene

Nominal Dia (mm)	Cat No.	Certs.	Dimensions (mm)		
			A	B	C
150	66NE300		845	720	150
225	69NE300		845	720	225
300	612NE300		845	720	300
			D	E	
			750	646	
			750	705	
			750	705	

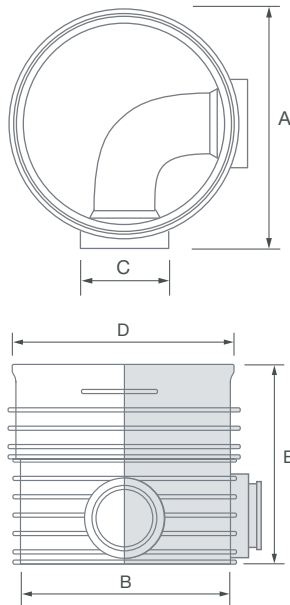

Equal Inspection Chamber Base

- 600mm diameter base incorporating a 90° bend
- To connect 150mm, 225mm and 300mm SuperSleve use adaptors TA/2 (with 150 base), TA/4 (with 225 base) and TA/7 (with 300 base)

Material: Polypropylene

Nominal Dia (mm)	Cat No.	Certs.	Dimensions (mm)		
			A	B	C
150	66NE314		798	720	150
225	69NE314		798	720	225
300	612NE314		798	720	300
			D	E	
			750	646	
			750	705	
			750	705	

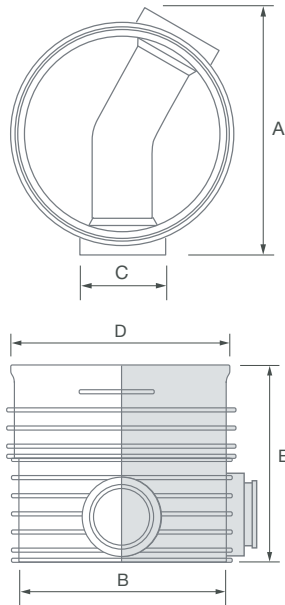

Equal Inspection Chamber Base

- 600mm diameter base incorporating a 30° bend
- To connect 150mm, 225mm and 300mm SuperSieve use adaptors TA/2 (with 150 base), TA/4 (with 225 base) and TA/7 (with 300 base)

Material: Polypropylene

Nominal Dia (mm)	Cat No.	Certs.	Dimensions (mm)		
			A	B	C
150	66NE315		845	720	150
225	69NE315		845	720	225
300	612NE315		845	720	300
			D	E	
			750	646	
			750	705	
			750	705	

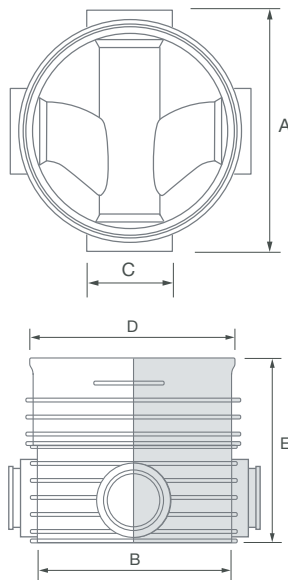

Equal Inspection Chamber Base

- 600mm diameter base incorporating straight through channel and 2 x 90° equal branch inlets
- To connect 150mm, 225mm and 300mm SuperSieve use adaptors TA/2 (with 150 base), TA/4 (with 225 base) and TA/7 (with 300 base)
- Step height for side connection = 30mm

Material: Polypropylene

Nominal Dia (mm)	Cat No.	Certs.	Dimensions (mm)		
			A	B	C
150	66NE316		845	720	150
225	69NE316		845	720	225
300	612NE316		845	720	300
			D	E	
			750	646	
			750	705	
			750	705	

Shaft

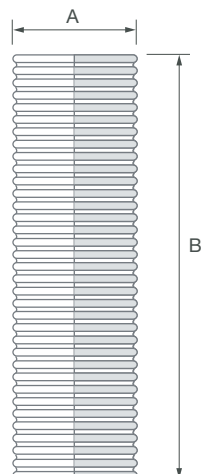

P/E Inspection Chamber Shaft

- 600mm dia. plain-ended corrugated shaft
- Length: 3 metres
- Can be cut to length to achieve required invert depth
- For use with all Range 600 bases

Material: Polypropylene

Nominal Dia (mm)	Cat No.	Dimensions (mm)	
		A	B
600	60NE003	683	3000*

*Dimension B = effective height

Cap

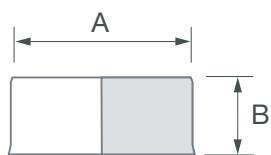
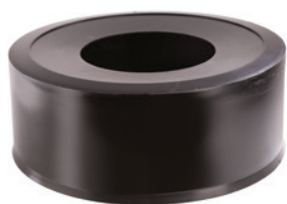

Restriction Access Cap

- For use with 60NE300 shaft
- Restricts access to 350mm diameter
- Supplied with one 600mm sealing ring

Material: Polypropylene

Nominal Dia (mm)	Cat No.	Dimensions (mm)	
		A	B
600	60NE930	704	270

Spares

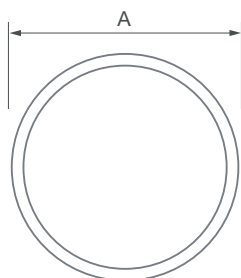

Chamber Base to Shaft Seal

- 600mm diameter for use with 60NE003 – at foot of shaft

Material: EPDM

Nominal Dia (mm)	Cat No.	Dimensions (mm)
		A
–	600TW117	600

Adaptors



Adaptors to SuperSleve

- For connecting SuperSleve to Range 600 inspection chamber bases

Material: Polypropylene/PVC-U

Nominal Dia (mm)	Cat No.
150	TA/2
225	TA/4
300	TA/7

Connection Kits

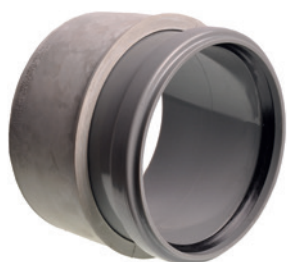

Backdrop Connector Kit – 100mm

- For connecting 100mm SuperSleve pipe to Range 450 and Range 600 shaft sections where a backdrop connection is required
- Use the following component, along with the SA15/1 adaptor

Material: PVC-U

Nominal Dia (mm)	Cat No.
110	NE950



Backdrop Connector Kit – 150mm

- For connecting 150mm SuperSleve pipe to Range 450 and Range 600 IC shaft sections where a backdrop connection is required
- Use the following component, along with the SA15/2 adaptor

Material: PVC-U

Nominal Dia (mm)	Cat No.
160	NE960

Design

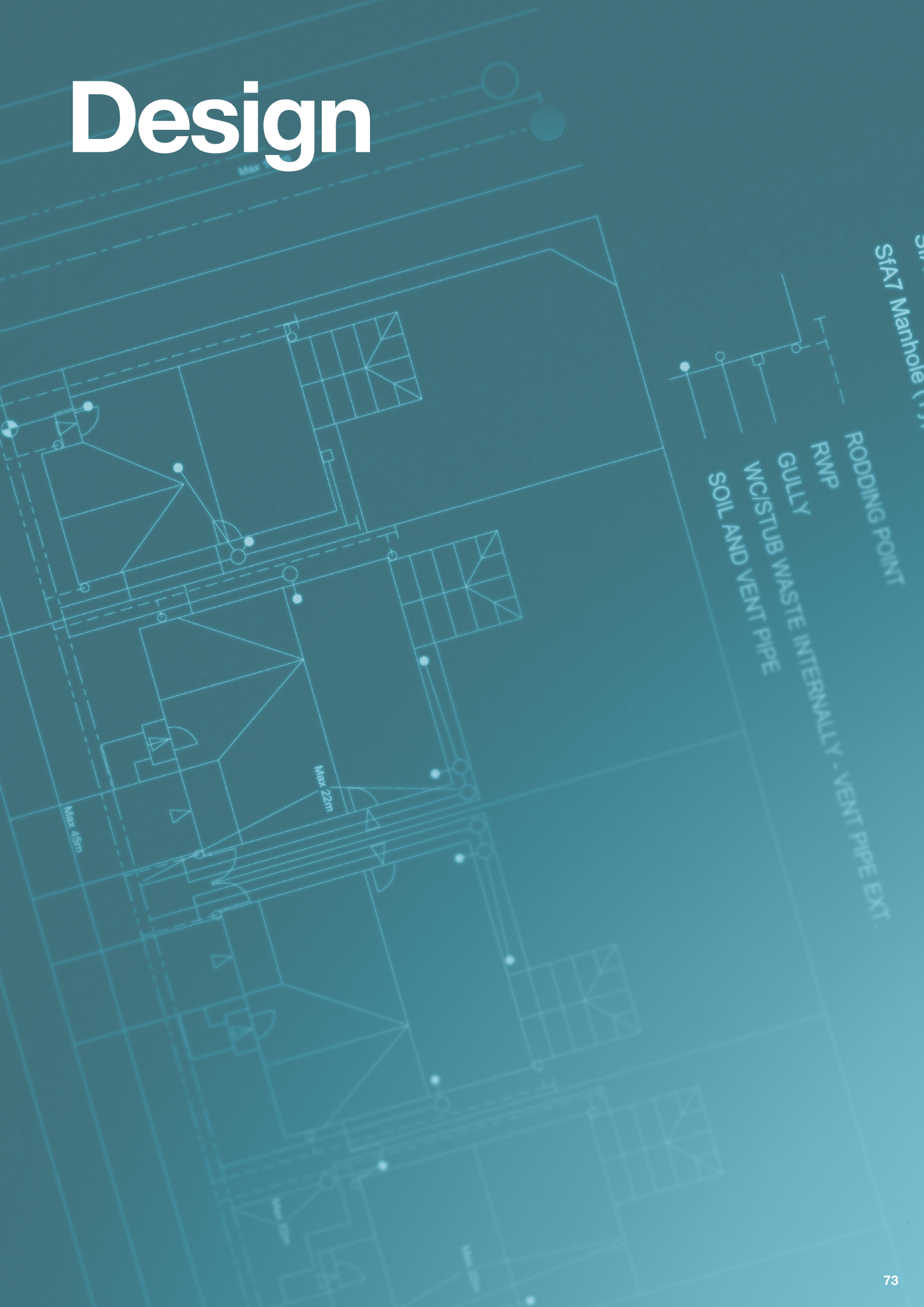

Design: Introduction

This design section has been written to assist drainage engineers and designers to successfully navigate the current legislation and guidance documents to successfully specify a Hepworth SuperSleve clay drainage system.

This guidance covers small to medium sized drains and sewers (DN100 – DN300) for both foul and surface water applications.

The number of reference documents has increased significantly in recent years, but the underlying design principles remain the same. It is no longer possible to refer to a single document to obtain a comprehensive design guide. This section refers to various sources as to where we believe the best contemporary guidance can be obtained.

Design sections

- Regulations and guidance documents
- Layout
- Hydraulic
- Structural
- Chemical
- Product specification

Private drainage

Regulations and guidance documents in different parts of the UK.

England and Wales

Building regulations set minimum standards for design, construction and alterations to almost every building. The regulations are developed by the UK government and approved by Parliament. The Building Regulations 2010 cover the construction and extension of buildings and these regulations are supported by Approved Document H which sets out detailed practical guidance on compliance with the regulations relating to drainage in:

England

- Approved Document H, for Drainage and waste disposal (in England this is found on the Planning Portal Website)

Wales

- Approved Document H, for Drainage and waste disposal (in Wales this is found on the Welsh Government Website)

Scotland

The Building Standards technical handbooks provide guidance on achieving the standards set in the Building (Scotland) Regulations 2004 and are available in two volumes, domestic buildings and non-domestic buildings. Detailed practical guidance on compliance with the regulations relating to domestic building drainage can be found under Section 3 – Environment.

- Building Standards technical handbook: domestic buildings

Northern Ireland

The Northern Ireland Building Regulations 2012 are the legal requirements made by the Department of Finance and Personnel. Guidance with respect to the requirements of these Building Regulations can be found in Technical Booklets.

- The document relating to Drainage is Technical Booklet N, Drainage

Alternative approach

The use of appropriate European Standards and/or British Standards is also accepted as a way of complying with the Building Regulations requirements. For further details please consult the relevant documents referred to below.

Layout

BS EN 752 Drain and sewer systems outside buildings. Sewer system management

Hydraulic

BS EN 16933-2 Drain and sewer systems outside buildings. Design. Hydraulic design

BS EN 12056-2 Gravity drainage systems inside buildings. Sanitary pipework, layout and calculation

Structural

BS 9295 Guide to the structural design of buried pipelines

BS EN 1295-1 Structural design of buried pipelines under various conditions of loading. General requirements

Sitework

BS EN 1610 Construction and testing of drains and sewers

Adoptable drainage

Sewers intended for adoption must meet the requirements of the local Water and Sewerage Company (WaSC).

Our commitment to specifiers

Hepworth Clay offers a wide range of support, including a specialised national sales team who understand the needs of those involved in the design process, and are on hand to offer advice on your project and the most suitable products.

We also have an internal technical advisory service who can provide technical advice over the telephone and email and answer any queries relating to our products. For specifiers of Hepworth Clay products, we are also able to assist with your drainage designs and layouts.

Design guidance

Who will be responsible for the drainage system when it's completed?

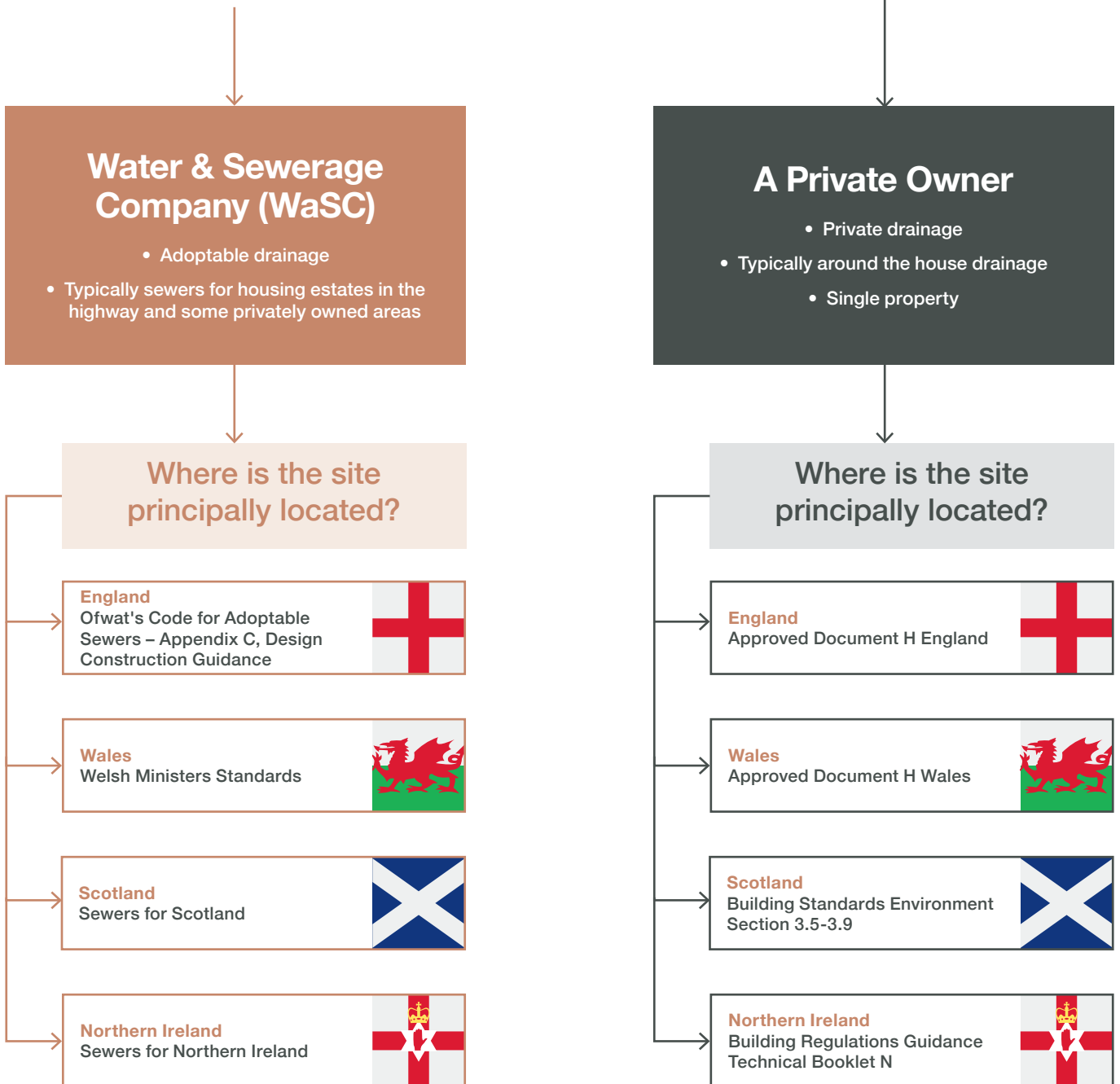

Alternative approach

The documents listed below can be used as an alternative approach to the current forms of guidance for adoptable and private drainage.

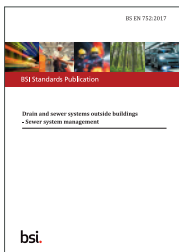

BS EN 752
Drain and sewer systems outside buildings – Sewer system management.

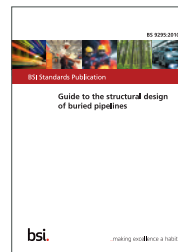

BS 9295
Guide to the structural design of buried pipelines.



BS EN 16933-2
Drain and sewer systems outside buildings. Design. Hydraulic design.

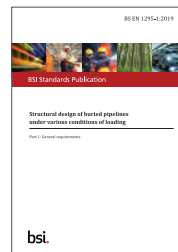

BS EN 1295-1
Structural design of buried pipelines under various conditions of loading.



BS EN 12056-2
Gravity drainage systems inside buildings. Sanitary pipework, layout and calculation.

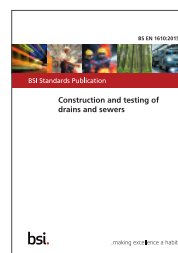

BS EN 1610
Construction and testing of drains and sewers.

Visit the BSI Group Shop online to purchase documents: shop.bsigroup.com

Design: Layout

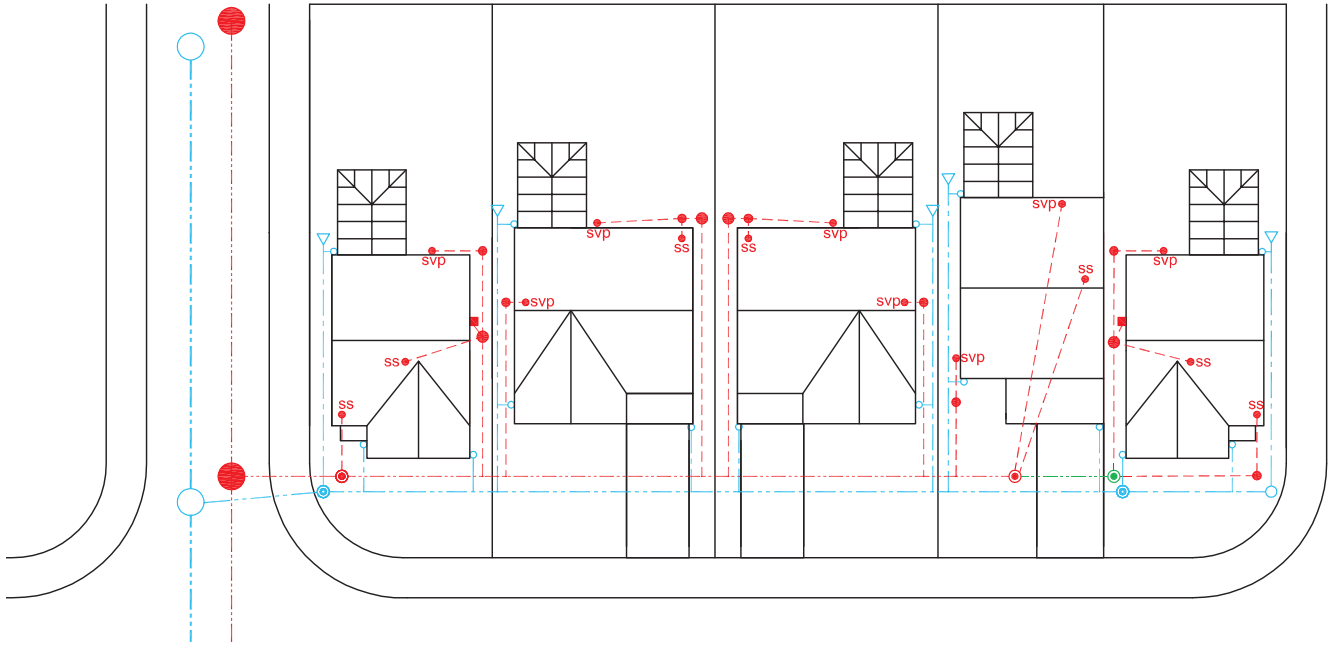

Typical site layout

An efficient and well designed drainage system should be self maintaining providing efficient service for the design working life of the drain and sewer system.

The overall design should take into account proposed flows, topography, site soil report, pipeline environment, applied structural loads and the effects of chemicals in and around the pipeline.

Symbol Key

Private Drainage

- Private drain run
- Soil and Vent Pipe
- WC / Stub Stack
- Waste Gully
- Rainwater Pipe
- Rodding Point
- Mini Access Chamber (max 0.6m depth)
- PPIC Inspection Chamber (max 1.2m depth)

Public Drainage

- Adoptable Sewer
- Lateral Drain
- Demarcation Chamber
- Range 450 Inspection Chamber (Type D) max. depth 3m
- DCG Manhole (Type B/C)

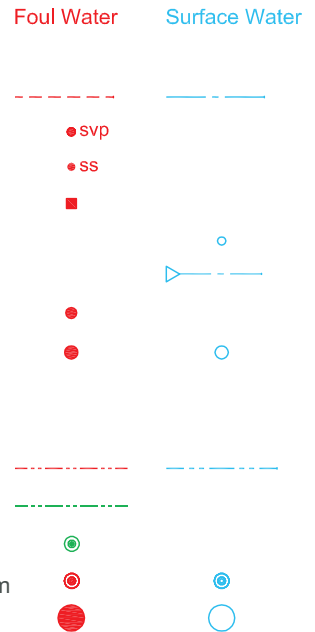

What is a drain?

A drain serves a single property within its boundary and the owner has responsibility for it.

What is a lateral drain?

A lateral drain serves a single property, but it continues outside that property's boundary, connecting it to the public sewer. The Water and Sewerage Company (WaSC) is responsible for it.

What is a sewer?

A sewer serves more than one property. It can be in private or publicly owned land. The WaSC is responsible for it.

Access to drains and sewers

Introduction

Access is required to drain and sewer systems for testing, inspection, maintenance and removal of debris and is covered by Building Regulations Approved Document H, section H1 and BS EN 752.

Suitable and sufficient access points should be provided for clearing blockages from drain and sewer runs without the need to enter buildings.

Types of access points

Access points should be one of four types as detailed in BS EN 752:

- Rodding points – small access points located at the upstream end of a drain or sewer that allow entry into the system for inspection, testing or cleaning in a downstream direction only.

- Access fittings – are normally located near the upstream end of a drain or sewer and allow entry into the system for inspection, testing or cleaning. The limited access offered by these fittings means that a full range of operations may not be possible.
- Inspection chambers – provide working space from ground level only, preventing personnel entry. They allow access into the system for inspection, testing or cleaning. The improved access offered by these fittings means that a wider range of operations is possible.
- Manholes – provide working space at drain or sewer level used for personnel entry and equipment. They provide entry into the system for inspection, testing or cleaning. The access offered by manholes means that a complete range of operations is possible.

Access fittings, Inspection chambers and manholes, allow inspection, testing or cleaning to be carried out in both directions.

Rodding Point

Depth: No limit
Diameter: 100 – 150mm

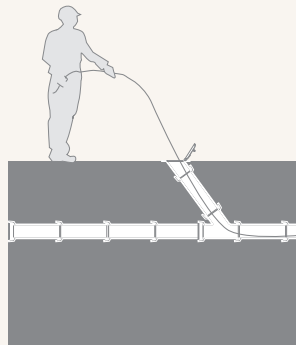

Polypropylene Inspection Chamber

Depth: up to 1200mm
Diameter: 475mm

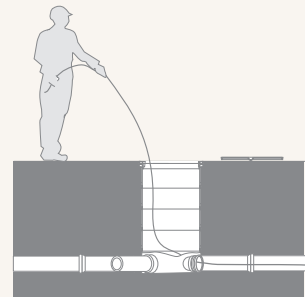

Access Fittings

Depth: up to 600mm
Access size: 260 x 100mm

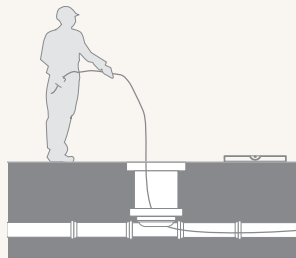

Range 450 Inspection Chamber

Depth: up to 3m
Shaft: 450mm diameter
Access opening restricted to 350mm diameter

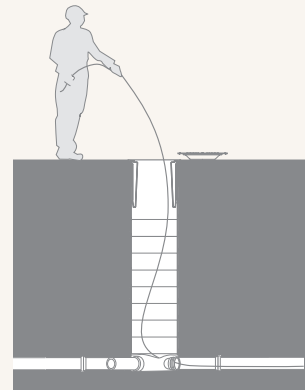

Mini Access Chamber

Depth: up to 600mm
Diameter: 300mm

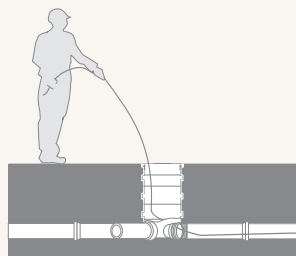

Positioning of access points

Access should be built on drains and sewers at every:

- Head of branch;
- Change of alignment (direction) or gradient;
- Junction of two or more drains or sewers;
- Change in pipe size.

Where the regular maintenance of intercepting traps, anti-flooding devices, or backdrops cannot be carried out from the surface, manholes should be installed.

Distance between access points

The distance between access points depends on the types of access used. BS EN 752 Table NA.4 indicates the recommended maximum distances between rodding points, access fittings, inspection chambers and manholes. These are based on manual cleaning techniques and the need for removing debris. This is shown schematically below.

Table NA.4 in BS EN 752 – Recommended maximum spacing of access provision (in metres)

	To junction / branch	To access fitting	To inspection chamber	To manhole
From start of external drain	–	12	22	25
From rodding point	12	12	22	45
From access fitting	12	12	22	45
From inspection chamber	12	22	45	45
From manhole	–	–	45	90 ^(a)

^(a) This may be increased to 200m in places where only remotely operated equipment will be used for maintenance.

Approved Document H, section H1 Table 13 also provides similar information. Differences may be found between the two tables but table NA.4 above is the simpler and more conservative of the two.

needs for all four types of access fittings. Inspection chambers conforming to BS EN 13598-1, BS EN 13598-2, and manholes conforming to BS 5911-4 are appropriate.

Building Regulations Approved Document H, section H1 table 11 gives minimum dimensions for access fittings and inspection chambers. Table 12 gives minimum dimensions for manholes.

Dimensions of access points

BS EN 752, NA.6.4.3 and NA.6.4.4 describe in detail the clear opening size at the surface and the dimensions for operational

Surface water

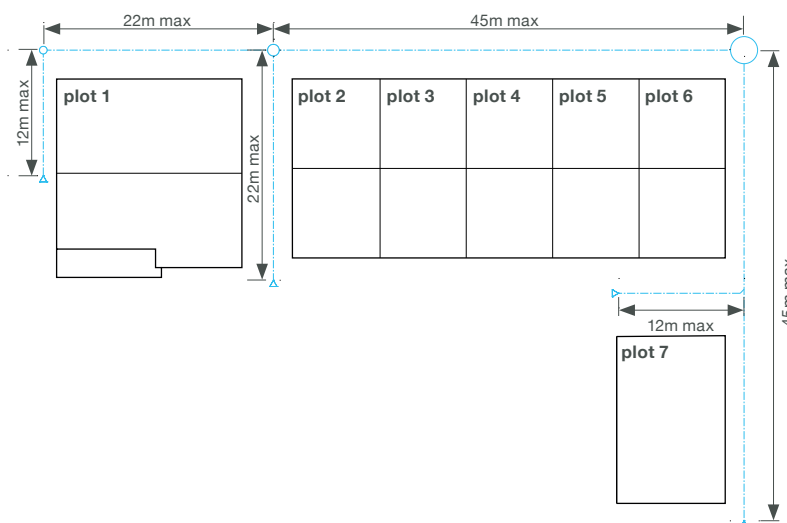

Symbol Key

- | | | |
|--------------------|-------------------|----------------------|
| | Foul Water | Surface Water |
| Manhole | ● | ○ |
| Inspection chamber | ● | ○ |
| Access fitting | ● | ○ |
| Stack | ● | |
| Rodding point | | ▷ |

Foul water

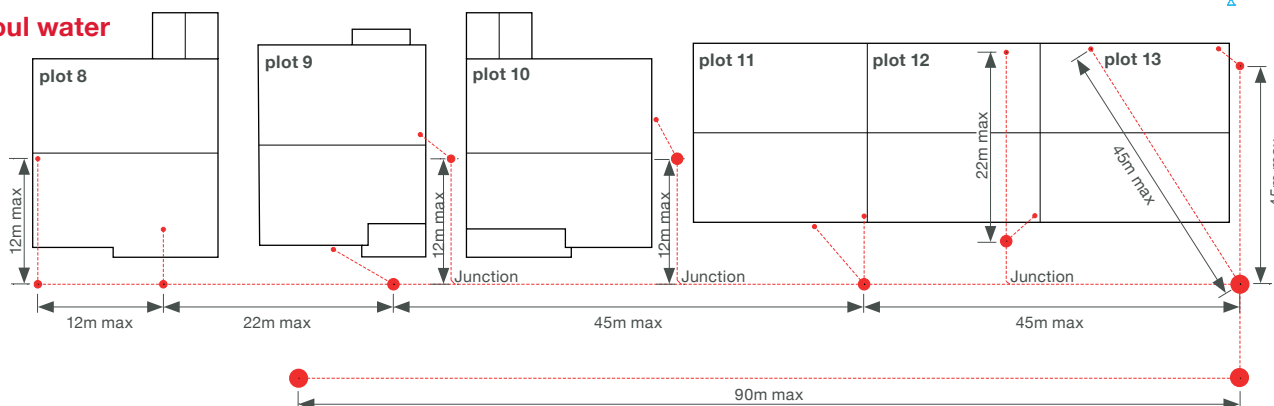

This drawing is to illustrate the recommended maximum spacing of access provision (in metres) for manual cleaning only. Diagrammatic only – not to scale.

Design: Hydraulic

Introduction

The primary objective of any hydraulic design is to ensure that the pipe sizing and gradients are selected to ensure both the accommodation of the maximum flow and the achievement of self-cleansing velocities. Excavation and cost can be minimised wherever possible and practical by following the topography of the site optimising trench depth.

Minimum Internal Diameter

The minimum internal pipe diameter for a foul or surface water drain or sewer is 100mm.

Minimum Gradients

The normal minimum or flattest gradients per diameter are shown below.

Foul water

DN100	1:40	Where there is no W.C. connected
DN100	1:80	Where at least 1 W.C. and less than 10 properties are connected
DN150	1:150	Where at least 10 properties are connected
DN225	1:225	A 'Rule of thumb' gradient of 1:DN, requires further calculation to verify
DN300	1:300	A 'Rule of thumb' gradient of 1:DN requires further calculation to verify

Surface water

DN100	1:100	
DN150	1:150	
DN225	1:225	A 'Rule of thumb' gradient of 1:DN, requires further calculation to verify
DN300	1:300	A 'Rule of thumb' gradient of 1:DN requires further calculation to verify

Maximum Gradients

There is no maximum value given for steep gradients in common use. Pipelines should be laid at gradients that are economical to install and maintain. Any steep gradient proposed by the designer should take the following into consideration.

Foul pipelines with low volume flows

Typically found at or near the head of the system in small diameter pipelines. The deposition of any solids is usually overcome by intermittent and subsequent flows moving the solids along to a free-flowing pipeline.

Foul pipelines with higher volume flows

At the end of a steep gradient the internal layout of the inspection chamber or the internal channel design of the manhole should be designed to reduce the potential for high velocity flows to cause deposition and accumulation of debris inside the chamber which will eventually cause a blockage (see page 120). It is not recommended to discharge high volume flows from steep gradients into a pipeline via a junction.

Hydraulic Pipeline Roughness Values

Hydraulic pipeline roughness value or k_s value reduces the effective flow capacity of drain and sewers, as biofilms present in operational drains and sewers attach to the internal surfaces of the pipeline, these build up and fall away repeatedly over time. This has a greater flow reducing effect than any difference between pipeline material, therefore a single conservative value can be used for each drainage system.

Foul and combined k_s 1.5mm and surface water k_s 0.6mm.

Design: Hydraulic

Design equations

The most generally accepted equation currently in use is that attributed to Colebrook and White. In this equation, the velocity of flow is related to the pipe bore, the kinematic viscosity of the liquid, the gradient and the hydraulic roughness of the pipeline.

When a pipe is conveying sewage or a combination of sewage and surface water, biological microfilms, adhere to and grow on the interior surface. This layer of biological microfilm is a major influence on the hydraulic roughness of pipelines and modifies the effect of various surface textures.

The Colebrook-White equation

The tables on the following pages are based on the Colebrook-White equation for transitional flow, the general form of which is:

$$\frac{1}{\sqrt{\lambda}} = -2 \log \left[\frac{K_s}{3.75} + \frac{2.5}{\text{Re}\sqrt{\lambda}} \right]$$

the equation, when expressed in engineering terms, becomes:

$$V = -2\sqrt{(2gDi)} \log \left[\frac{K_s}{3.7D} + \frac{2.5lv}{Dv\sqrt{2gDi}} \right]$$

where

$$\lambda = \text{Friction coefficient, } \frac{2g Di}{v^2}$$

V = Discharge velocity (m/s)

g = Gravitational acceleration
(9.81 m/sec²)

i = Hydraulic gradient

v = Kinematic viscosity of fluid (m²/sec)
at 10°C (1.31 X 10⁻⁶m²/sec)

K_s = Linear measure of effective roughness (0.6 or 1.5mm)

D = Nominal internal diameter of pipe
(100 to 600mm)

$$\text{Re} = \text{Reynolds number, } \frac{VD}{v}$$

The tables developed from this equation may be used to determine the average velocity of flow and the discharge for pipes with an effective roughness (k_s) of 0.6mm for surface water sewers and 1.5mm for foul sewers and combined sewers. These values are stated in 'Ofwat's Code for Adoptable Sewers – Appendix C, Design Construction Guidance'.

Table 6: Roughness (K_s) 1.50 –
Pipe flowing full

Table 7: Roughness (K_s) 1.50 –
Pipe flowing 3/4

Table 8: Roughness (K_s) 0.60 –
Pipe flowing full

Pipe sizing

Foul drainage

For foul drains serving individual or small groups of buildings the peak flow rate can be calculated using the discharge unit method shown in **BS EN 16933-2** and **BS EN 12056-2**. The peak flow is derived from the number and type of appliances connected and the frequency at which they discharge. Table 3 shows the appropriate discharge units allocated to a range of sanitary appliances. The table refers to system III values shown in **BS EN 12056-2**.

Table 3

Appliance	Discharge Units
Wash hand basin, bidet	0.3
Shower (without plug)	0.4
Shower (with plug)	1.3
Single urinal with cistern	0.4
Slab urinal	0.2
Bath	1.3
Kitchen sink	1.3
Dishwater (domestic)	0.2
Washing machine (<6kg)	0.6
Washing machine (<12kg)	1.2
WC with 6 litres cistern	1.2-1.7**
WC with 7.5 litres cistern	1.4-1.8**
WC with 9 litres cistern	1.6-2.0**

*Per person -** Depending on type

The flow rate in a foul drain is calculated using the following formula:

$$Q = k\sqrt{\sum DU}$$

Where Q = Flow rate

k = Frequency factor

∑DU = Sum of Discharge Units

The frequency factor for various types of building usage is shown in table 4.

Table 4

Type of building	Frequency factor (k)
Intermittent use, e.g. dwelling, guest house, office	0.5
Frequent use, e.g. hospital, school, restaurant, hotel	0.7
Congested use, e.g. toilets and showers open to the public	1.0
Special use, e.g. laboratory	1.2

Example calculation

Calculate the peak flow rate and size the outfall drain from a medical centre containing 10 WCs, 15 WHBs, 3 sinks, 1 dishwasher, 2 showers.

Total number of discharge units:

$$- 10 \times 1.7 \text{ (WCs)} = 17.0$$

$$- 15 \times 0.3 \text{ (WHBs)} = 4.5$$

$$- 3 \times 1.3 \text{ (Sinks)} = 3.9$$

$$- 1 \times 0.2 \text{ (Dishwasher)} = 0.2$$

$$- 2 \times 0.4 \text{ (Showers)} = 0.8$$

Total = 26.4

Using frequency factor of 0.7:

$$Q = 0.7\sqrt{26.5} = 3.6 \text{ l/sec}$$

Design: Hydraulic

Worked examples

Pipe size and gradient selection

Using table 7, which gives pipe capacities when flowing at 3/4 full, select a pipe size and gradient which will accommodate the peak flow rate. Do not exceed minimum gradient values set by **BS EN 16933-2** and Building Regulations.

For a peak flow 3.6 l/sec a 100mm diameter pipe laid at 1:80 (capacity at 3/4 depth = 5.3 l/sec) should be adequate.

The following calculations are then used to check that the velocity of the flow is greater than 0.7 l/sec (self cleansing velocity).

- 1 Read the pipe full velocity and capacity for the selected pipe and gradient in table 6. For a 100mm pipe at 1:80 these are 0.75 m/sec and 5.6 l/sec
- 2 Calculate the proportional discharge by dividing the peak flow rate by the pipe capacity flowing full
i.e. $3.6/5.6 = 0.643$
- 3 From table 5 read off the proportional velocity value when the proportional discharge is 0.643 i.e. 1.06
- 4 Multiply the pipe full velocity by the proportional velocity to calculate the actual velocity in the pipe i.e. $0.75 \times 1.06 = 0.8\text{m/sec}$. Actual velocity exceeds 0.7m/sec, therefore pipe is adequately sized.

Surface water drainage

For surface water drains serving impermeable areas no greater than 4000m², Building Regulations Approved Document H, section H3 suggests a rainfall intensity of 50mm/hr may be used for normal situations. For the design of drainage serving larger areas or areas where ponding would lead to flooding of buildings, site-specific rainfall data should be calculated based upon the storm frequency, duration and level of protection required for the building. For further details, please refer to BS EN 752 and BS EN 16933-2.

A 50mm/hr rainfall intensity generates 0.014 l/sec per square metre of impermeable area (assuming the surface to be drained has 100% impermeability).

$$\frac{50\text{mm / hr}}{60 (\text{mins}) \times (60 \text{ sec})} = 0.014 \text{ l/sec}$$

The flow rate contributing to a surface water drain can be calculated by multiplying the impermeable area to be drained in metres squared by this factor.

Example calculation

The same medical centre has a roof area of 350m² and a car park of 500m². Calculate the size of the surface water drain required at the outfall to the main sewer.

Calculate the total contributing impermeable area $350 + 500 = 850\text{m}^2$.

Multiply the total impermeable area by the rainfall intensity factor $850 \times 0.014 = 11.9 \text{ l/sec}$.

From Table 8 (Pipe flowing full – K_s 0.6) select a pipe diameter and gradient to accommodate the flow. In this example a 100mm pipe at 1:25 would accept the flow of 11.9 l/sec and where the full-bore velocity is greater than 1.0 m/sec.

This could be too steep to be practical for some sites therefore a larger diameter pipe should be selected where the full-bore velocity is not less than 1/m sec. A 150mm pipe at 1:100 with a full-bore velocity of 1.0 m/sec will satisfy this requirement, leaving almost 50% additional capacity for future flows to be added without any major pipeline replacement work.

Proportional velocity and discharge in pipes running part full

Table 5

Proportional Depth	Proportion of full-bore values	
	Velocity	Discharge
0.02	0.128	0.001
0.04	0.213	0.003
0.06	0.283	0.007
0.08	0.345	0.013
0.10	0.400	0.021
0.12	0.450	0.031
0.14	0.496	0.042
0.16	0.539	0.056
0.18	0.580	0.071
0.20	0.618	0.088
0.22	0.654	0.107
0.24	0.688	0.127
0.26	0.720	0.149
0.28	0.750	0.172
0.30	0.779	0.197
0.35	0.846	0.264
0.40	0.904	0.338
0.45	0.955	0.417
0.50	1.000	0.500
0.55	1.038	0.585
0.60	1.071	0.671
0.65	1.097	0.755
0.70	1.117	0.835
0.75	1.130	0.909
0.80	1.136	0.974
0.85	1.134	1.027
0.90	1.121	1.063
0.95	1.092	1.072

Design: Structural

The structural design of the cross-section of rigid clay pipes is to ensure the optimum materials and embedments are selected for a given installation.

The process of structural design is about effectively matching the loads generated by the design environment (Fig 1 a) to the load-bearing capacity of the pipe, trench width and its embedment (Fig 1 b) which are selected by the designer to achieve an appropriate factor of safety.

Fig. 1 – Design considerations

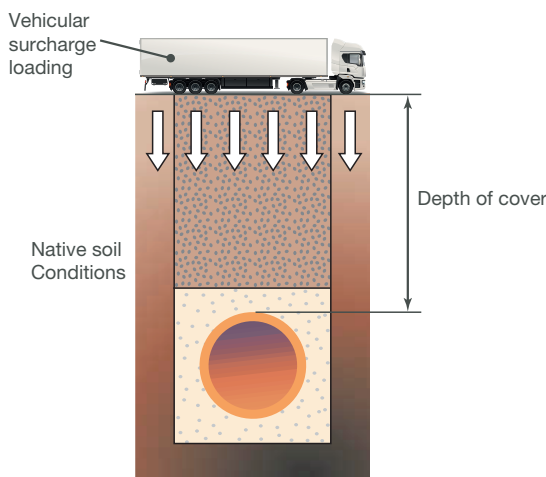

a) Factors to be considered in the design environment

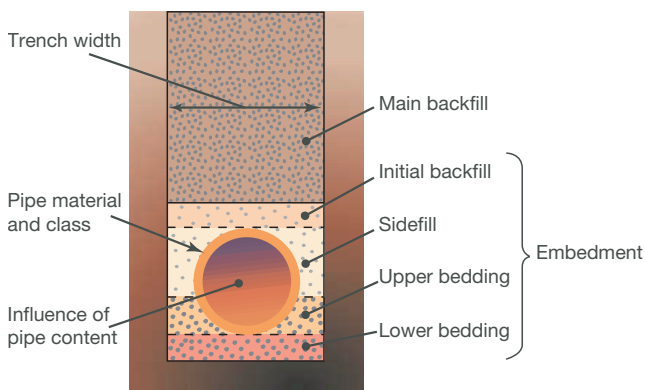

b) Factors to be considered – Designer controlled parameters

NOTE: This terminology is consistent with the definitions in BS EN 1610.

Clay pipe behaviour

Clay pipe is classified as a rigid pipe material and has a low strain capacity and high relative stiffness and is designed on the basis of its high inherent strength.

Clay pipe design

Introduction

Clay pipes rely on their embedment to distribute the loads imposed by vehicular surcharge loading and the depth of backfill to reduce the circumferential bending moments in the pipe walls. The response of a clay pipe to the loading is to settle marginally into its embedment until sufficient reaction is achieved.

Wide and narrow trench loading

There are two installation conditions: pipes installed in wide trenches or embankments and pipes installed in narrow trenches.

Both narrow and wide trench conditions should be calculated for the selected maximum trench width and the lower of the two loads used in the design specifying the installation condition. If the design parameters cannot be controlled on site with certainty, it is safer to assume the trench will be wide.

It is recommended that the wide trench condition is used in the design parameters for clay pipes, as it does not matter if the trench is dug wider than the design parameters. The installation result will be safe and conservative.

Bedding factors

A bedding factor is the ratio by which a clay pipes crushing strength is enhanced when installed using different embedment classes. Fig. 2 page 90.

The load bearing capacity of a clay pipeline in the ground is the crushing strength of the pipe as given in table 2 page 15 multiplied by the bedding factor. e.g. 300mm diameter SuperSleve pipe, with a crushing strength of 72 kN/m x 2.5 (Class B or S) =180 kN/m

The purpose of the embedment is to distribute the vertical loads (and the corresponding support reaction) around the pipe. For example, a minimal embedment such as class D or N hardly distributes the loads at all and results in a bedding factor of 1.1 (see Fig. 2 page 90). Whereas a full embedment such as class S, provides a greater load distribution and achieves a higher bedding factor of 2.5.

Minimum bedding factor and factor of safety

The process of structural design is about effectively matching the imposed loads to the load bearing capacity of the pipeline and its embedment to achieve an overall and appropriate factor of safety. The required minimum bedding factor can be calculated as the example below:

Bedding factor =

$$\frac{\text{Total load on the pipeline (soil load + traffic load)} \times \text{Factor of safety (1.25)}}{\text{Pipe crushing strength}}$$

The factor of safety for clay pipes is 1.25.

Worked example

Design of a SuperSleve pipeline in accordance with BS 9295, Clause 6 Rigid pipe design and Annex A.26.2

Clauses (i.e. 6.10.2), equations Eq (3) and tables listed in the following worked example, reference the appropriate parts of BS 9295.

Symbols used in the following worked example

Symbol	Description	Unit
B_c	outside diameter of pipe	m
B_d	effective width of trench	m
C_c	soil load coefficient in embankment conditions	–
C_w	water load coefficient	–
D	mean diameter of pipe (measured to neutral axis of wall)	m
F_m	bedding factor	–
F_{se}	factor of safety for rigid pipe material (external load design)	–
H	depth of cover to top of pipe	m
P_s	vehicle surcharge pressure	kN/m ²
ρ	projection ratio	–
r_{sd}	settlement deflection ratio	–
t	pipe wall thickness	m
W'_c	soil load per unit length of pipe in embankment or wide trench conditions	kN/m
W_{csu}	concentrated surcharge load per unit length of pipe	kN/m
W_e	total design external load per unit length of pipe	kN/m
W_t	crushing strength of rigid pipes (maximum load for clay pipes)	kN/m
W_w	weight of liquid content of pipe in kilonewtons per metre	kg/m
γ	unit weight of soil	kN/m ³
γ_w	unit weight of water	kN/m ³

Design criteria

- 300 mm diameter clay pipe to BS EN 295-1, Class 240
- Cover depth from road level to top of pipe = 6.0 m
- Subject to main road loading
- Limited control over installation and trench width

Design data

Wide trench design

Internal diameter	$DN = 0.30$ m
Wall thickness	$t = 0.029$ m
External diameter	$B_c = 0.358$ m
Trench width	$B_d = \text{Wide}$
Soil density	$\gamma = 19.6$ kN/m ³

If site investigation information is not available consider using conservative properties in BS 9295 clause 6.6

Design: Structural

Wide trench load

W'_c	$= C_c \gamma B_c^2$	6.10.2
From 6.5	$r_{sd}\rho$	Eq (3)
	$= 0.5$ for bedding class B or S	
C_c	$= 1.5 \times (6.0/0.358) - 0.07$	$= 25.07$
		Table 7
W'_c	$= 25.07 \times 19.6 \times 0.358^2$	$= 62.98$ kN/m

Concentrated surcharge load

W_{CSU}	$= P_s B_c$	6.10.4
From Table 2	$H = 6.0, P_s = 15$ kN/m ²	Eq (7)
W_{CSU}	$= 15 \times 0.358$	$= 5.37$ kN/m

Water load

$W_w = C_w \gamma_w \pi (D-t)^2 / 4$	where $C_w = 0.75$	6.10.5
$D = 0.30 + 0.029$		Eq (8)
$W_w = 0.75 \times 9.81 \times 3.142 \times (0.329 - 0.029)^2 / 4$		$= 0.329$
		$= 0.52$ kN/m

Total external load

W_e	$= W'_c + W_{CSU} + W_w$	6.10.6
	$= 62.98 + 5.37 + 0.52$	Eq (9)
		$= 68.87$ kN/m

Bedding factor required

F_m	$\geq W_e F_{se} / W_t$ (or W'_t)	6.11
Clay pipe	$F_{se} = 1.25$	Eq (10)
Class 240 pipe	$W_t = 240 \times 0.30$	$= 72$ kN/m
		Table 8
F_m	$\geq 68.87 \times 1.25 / 72$	$= 1.20$

Note: See page 87 for explanation of references, symbols, design criteria and design data used in this worked example.

With this result, you should therefore:

Provide Class F bedding in a wide trench condition where F_m provides = 1.9

or

Provide Class B or S bedding in a wide trench condition where F_m provides = 2.5

See Fig. 2 – Construction of trench beddings for clay pipes (page 90).

From table 9 (page 89), a DN 300 clay pipe embedded within a class F, B or S bedding can be laid between the depths of 0.6 – 10.0m

Additional margin of safety example

The result of the structural design calculation requires a minimum bedding factor of 1.2, based upon the design criteria, which has a safety factor of 1.25 built in.

The bedding class that should be selected for use must be equal to or higher than that of the design requirement. In this case Class F with a bedding factor of 1.9. This provides a level of support that is +58% higher than the design requirement which is based upon conservative values. As is typical with most specifications and site construction, a class S bedding with a bedding factor of 2.5 is specified and used, this detail provides a level of support that is +108% higher than the design minimum requirement.

This significant and ultimately safe headroom provides the safety margin for current and future unforeseen site design considerations (fig 1, page 86) that may have a reducing effect upon the level of support provided to the pipeline, leading to a safe installation for the long term.

Specifying and installing Hepworth Clay protects the reputation of both the specifier and the installer.

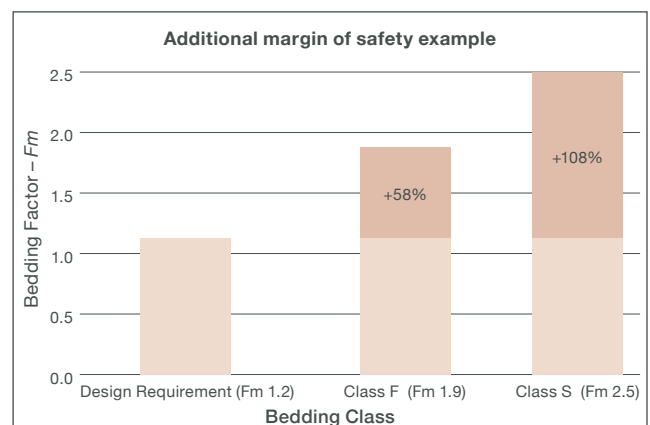

Simplified bedding table for SuperSleve and HepLine vitrified clay pipes

Table below has been simplified from the information given in the bedding construction tables available from the Clay Pipe Development Association (CPDA) and is compatible with the method of calculation described in BS 9295. Guide to the structural design of buried pipelines.

The following parameters have been used.

Pipes and pipe strengths

Table 9 covers Hepworth SuperSleve and HepLine vitrified clay pipes complying with the crushing strengths and classes specified in BS EN 295-1. Pipe strengths may be specified by class number as an alternative to crushing strength. Class number can be derived from the following formula.

$$\text{Class number} = \frac{\text{Crushing strength} \times 1000}{\text{Nominal diameter}}$$

Pipe embedments and bedding factors

Table 9 and Fig. 2 shows rigid pipe embedment classes D (1.1), N (1.1), F (1.9), B (2.5) and S (2.5).

Loading conditions

Loads have been calculated for pipes laid in trenches either in main roads or in fields and gardens to cover the range of normal applications.

Trench widths

Table 9 assumes wide trench conditions. Full calculations for narrow trenches could result in more economic excavation and use of bedding materials or greater depth of application for the same pipe strength. The specified trench width and embedment design must be installed as per the specification on site, if it is thought that this cannot be achieved on site use wide trench conditions instead.

Depths of cover

Table 9 sets out the applicable ranges of depths of cover for each pipe size, pipe strength, loading condition and type of embedment, with a maximum depth shown limited to 10.0m.

At shallower depths, particularly less than 0.6m, there might be additional considerations to be taken into account, as set out in the technical notes starting on page 99 in this guide.

Table 9 – Simplified bedding table for SuperSleve and HepLine vitrified clay pipes

Nominal diameter (mm)	Bedding construction class	Bedding factor	Pipe strength class	Crushing strength (kN/m)	System type	Main roads (m)	Fields and gardens (m)
100	D or N	1.1	–	28	HepLine	0.4 - 5.7	0.4 - 6.0
				40	SuperSleve	0.4 - 8.5	0.4 - 8.7
	F	1.9	–	28	HepLine	0.4 - 10.0	0.4 - 10.0
				40	SuperSleve	0.4 - 10.0	0.4 - 10.0
	B or S	2.5	–	28	HepLine	0.4 - 10.0	0.4 - 10.0
				40	SuperSleve	0.4 - 10.0	0.4 - 10.0
150	D or N	1.1	–	28	HepLine	0.7 - 3.4	0.6 - 4.0
				40	SuperSleve	0.6 - 5.6	0.6 - 5.9
	F	1.9	–	28	HepLine	0.6 - 6.9	0.6 - 7.1
				40	SuperSleve	0.6 - 10.0	0.6 - 10.0
	B or S	2.5	–	28	HepLine	0.9 - 9.3	0.6 - 9.4
				40	SuperSleve	0.6 - 10.0	0.6 - 10.0
225	D or N	1.1	160	36	HepLine	0.9 - 2.7	0.6 - 3.5
			200	45	SuperSleve	0.6 - 3.9	0.6 - 4.4
	F	1.9	160	36	HepLine	0.6 - 5.9	0.6 - 6.2
			200	45	SuperSleve	0.6 - 7.6	0.6 - 7.8
	B or S	2.5	160	36	HepLine	0.6 - 8.0	0.6 - 8.2
			200	45	SuperSleve	0.6 - 10.0	0.6 - 10.0
300	D or N	1.1	160	48	HepLine	0.8 - 2.7	0.6 - 3.5
			240	72	SuperSleve	0.6 - 5.1	0.6 - 5.4
	F	1.9	160	48	HepLine	0.6 - 6.0	0.6 - 6.3
			240	72	SuperSleve	0.6 - 9.3	0.6 - 9.5
	B or S	2.5	160	48	HepLine	0.6 - 8.1	0.6 - 8.3
			240	72	SuperSleve	0.6 - 10.0	0.6 - 10.0

Design: Structural

Fig. 2 – Construction of trench beddings for clay pipes

Class D Bedding Factor 1.1

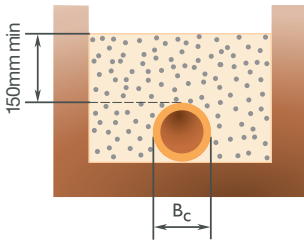

Trimmed trench bottom.

Class N Bedding Factor 1.1

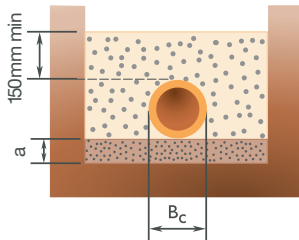

Granular material bed

Class F Bedding Factor 1.9

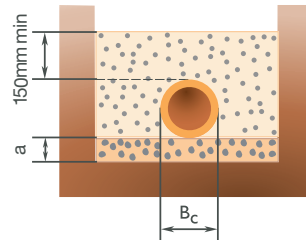

Single size granular material bed.
Generally suitable for all conditions.

Class B Bedding Factor 2.5

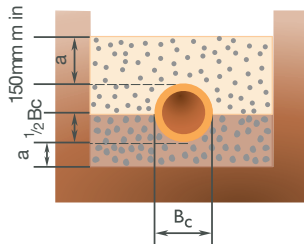

Granular bed and haunch.
Generally suitable for all soil conditions.

Class S Bedding Factor 2.5

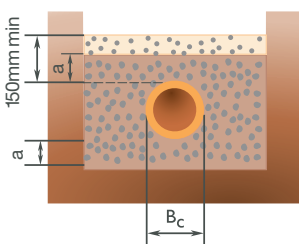

Granular surround.
Generally suitable for all soils.

Bedding Factor 4.5

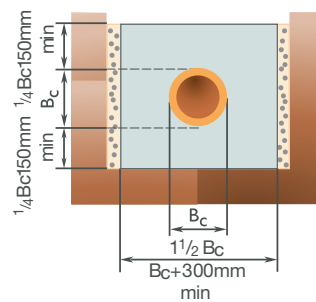

Plain concrete surround.
Generally suitable for all conditions.

Dimension a

In machine-dug uniform soils:

$a =$ For sleeve jointed pipes, a minimum of 50mm or $1/6 B_c$ whichever is the greater.

In rock or mixed soils containing rock bands, boulders, large flints or stones or other irregular hard spots:

$a =$ For sleeve jointed pipes, a minimum of 150mm or $1/4 B_c$, whichever is the greater.

For a concrete surround the bedding factor is 4.5. For a reinforced concrete surround, an increased bedding factor of 4.8 can be used, provided that the area of transverse steel is at least 1.0% both above and below the pipe, and there is vertical steel jointing this main steel. This bedding factor has been derived from the 4.8 for a 1.0% reinforced concrete arch. A concrete arch is not a practicable construction.

key

-  Graded or all-in aggregate or compacted sand or suitable as-dug material.
-  Fill selected from excavated material and lightly compacted by hand.*
-  Undisturbed natural soil.
-  Concrete 28 days cube strength to be at least 20 MN/m².
-  Single-size granular material.

*Selected fill: Selected fill should be readily compactable, free from timber, frozen material, vegetable and foreign matter exclude hard lumps of clay retained on a 100mm sieve and stones on a 40mm sieve.

Design: Chemical resistance

Clay pipes, couplings and sealing ring selection

The SuperSleve drainage system has two rubber sealing ring options, EPDM and Nitrile. Each has a specific capability and therefore resistance to contamination found in discharged effluent, groundwater and sub-soil.

Chemical contaminants typically originate from effluent inside a pipeline, usually identified by the production and cleaning process of a factory. Hydrocarbon contaminants are typically found in the subsoils and groundwaters outside of the pipeline and are detailed in the soil investigation report.

The ethylene propylene diene monomer rubber (EPDM) sealing ring is capable of resisting effluent within the pH range 2 to 12 at normal ambient temperatures. Surges of pH outside these limits can be accommodated provided that the pipeline is subsequently flushed with water or aqueous waste within these limits. EPDM sealing rings are particularly suitable for general chemical and acid and alkali conditions. It is difficult to give precise limits of acceptability that will cover all cases, since any combination of concentration, temperature and composition will affect the nature of the effluent.

The EPDM sealing ring is held captive in a Polypropylene coupling, which itself has a very high order of chemical resistance.

The Nitrile sealing ring is capable of resisting contamination involving oil and petrol type (hydrocarbon) contamination. Caution should be exercised if organic solvents are present,

since these can adversely affect the rubber sealing rings. Any such contamination should be identified in the soil investigation report. Specific advice should be sought in these cases from the Hepworth Clay Technical Advisory Service.

Vitrified Clay pipes are ideally suited for brownfield site applications involving direct contact with contaminated ground. The same considerations should apply to the coupling and sealing ring material. Additional precautions sometimes need to be taken. This can be surrounding the pipeline with imported uncontaminated fill and in extreme cases wrapping the pipe joints with a suitable barrier material. In sulphate bearing ground clay pipes with normal EPDM seals are appropriate.

Vitrified Clay pipe systems are the ideal choice for systems that are prone to stagnant sewage and septicity, they are unaffected by the effects of hydrogen sulphide (H₂S) build up.

The evaluation of effluents and selection of appropriate pipe materials can be complex and difficult. Further guidance on the resistance of materials to various chemicals is available in "The specification, design and construction of drainage and sewerage systems using vitrified clay pipes." published by the Clay Pipe Development Association (CPDA) and in table 10 below.

The clay pipes themselves are resistant to most chemicals with the exception of hydrofluoric acid (HF).

Further help and advice on the performance of clay pipe systems and their resistance to chemicals can be obtained by contacting the Hepworth Clay Technical Advisory Service.

Table 10 – General guidance for resistance of materials to chemical contamination

Material	No chemical contamination	At normal temperature		Organic solvents	Containing oils and fats		At high temperature		Soil environment containing	
		Acids	Alkalis		Vegetable	Mineral	Acids	Alkalis	Sulphates	Acids
Clayware pipes and fittings	A	S	S	S	S	S	A	A	S	S
Nitrile Rubber	A	A	A	E	A	A	E	A	A	A
EPDM Rubber	A	A	A	E	A	E	A	A	A	A
Polypropylene	A	S	S	A	S	A	A	A	S	S

A = normally suitable

E = need expert advice, each case to be considered on its own merits

S = specially suitable

Note: It is important to take account of quantities and concentrations on all types of chemical likely to be encountered.

Design: Product specification

Manufacturer details:

Wavin Limited
Edlington Lane
Edlington
Doncaster
DN12 1BY

T: 0800 038 0088
E: drainage@hepworth.co.uk
W: hepworthclay.co.uk

Technical tools, and How to Videos can all be accessed from the Hepworth Clay web site www.hepworthclay.co.uk

Overview – Hepworth Clay

SuperSleve and HepLine clay drainage system comprises a range of vitrified clay pipes, bends, junctions and fittings available in 100mm, 150mm, 225mm and 300mm diameters.

SuperSleve is suitable for use in adoptable sewers, housing, commercial, industrial and highway applications. Correctly installed it has a lifetime expectancy of over 100 years.

SuperSleve Specification Clause

SuperSleve – for foul and surface water applications, manufactured to:

BS EN 295-1 Vitrified clay pipe systems for drains and sewers. Requirements for pipes, fittings and joints.

Drains and sewers from 100mm to 300mm diameter shall be constructed using Hepworth SuperSleve Vitrified Clay Pipes, fittings and push fit flexible couplings with EPDM rubber sealing rings kitemarked to BS EN 295-1, joint system E. Installed in accordance with the manufacturers recommendations with the following minimum pipe crushing strengths.

Minimum Pipe Crushing strength	
100 mm – 40 kN/m	Pipe class – not applicable
150 mm – 40 kN/m	Pipe class – not applicable
225 mm – 45 kN/m	Class 200
300 mm – 72 kN/m	Class 240

Lifetime Jetting Guarantee

Hepworth SuperSleve clay pipes are guaranteed for the system lifetime against penetration of the pipe wall caused by the following jetting criteria:

- High pressure water jet used at a pressure of up to 7,500 psi (517 bar)
- At a flow rate not exceeding 20 gallons per minute (1.5 litres per second)
- Held immobile for a constant period of not more than 5 minutes

* When laid in accordance with our instructions and the requirements of the codes of practice and guides relevant to their use.



Brownfield sites

Brownfield sites should be the first choice for redevelopment land. Often brownfield sites have been used for commercial and industrial purposes before being left derelict and possibly contaminated.

Brownfield sites offer a challenging environment to the specification of any drainage system. The challenges relate to the likely presence of chemical contaminants and debris of previous construction, sub-surface voids and high-water tables. These factors call for a vitrified clay pipeline with inherently high structural strength and bending moment resistance. The mass of the pipeline also resists floatation.

Chemical and hydrocarbon hot spots are often removed from site where practicable, however some level of contamination may remain. Vitrified clay pipelines offer the best protection as they are chemically inert and resistant to attack from virtually all chemicals.

The standard rubber sealing rings (EPDM) are suitable for all domestic drainage applications and non-contaminated sites. They have a pH range of 2 to 12 making them suitable for general chemical and acid/alkali conditions. Special purpose Nitrile rubber sealing rings are suitable for applications involving hydrocarbons, (petrol, diesel and oil type contamination) either in the ground or the effluent.

Further help and advice on the specification of Hepworth Clay drainage systems can be obtained by contacting the Hepworth Clay Technical Advisory Service.

HepLine Specification Clause

HepLine – for subsoil infiltration and exfiltration applications manufactured to:

BS EN 295-5 Vitrified clay pipe systems for drains and sewers. Requirements for perforated pipes and fittings

Land Drains from 100mm to 300mm diameter shall be constructed using Hepworth HepLine Vitrified Clay Pipes, fittings and push fit flexible couplings with EPDM rubber sealing rings kitemarked to BS EN 295-5, joint system E. Installed in accordance with the manufacturers recommendations with the following minimum pipe crushing strengths.

Minimum Pipe Crushing strength	
100 mm – 28 kN/m	Pipe class – not applicable
150 mm – 28 kN/m	Pipe class – not applicable
225 mm – 36 kN/m	Class 160
300 mm – 48 kN/m	Class 160

Further details for site work can be found in the installation section in this document.

Product specification clauses can also be accessed via the NBS website ribaproductselector.com. Search for Hepworth Clay.

Installation



Installation

Planning, delivery, handling and storage

Planning

Before delivery takes place, thought should be given to the locations and sequence in which the various items will be used, so that delivery, receipt and storage can be arranged accordingly.

It is important that good care is taken on site to prevent unnecessary wastage of materials and time and for the prevention of problems after laying thus causing delay and additional expense.

Layout drawings should be checked to avoid expensive adjustments at a later stage.

Delivery

Mechanical Off-Loading (M.O.L) by Trailer Mounted Forklift is available on request for direct to site deliveries only. Not available for branch deliveries.

You should be aware that there is limited availability of mechanical off-load vehicles, and in busy periods there may be a lead time for this service.

A stable, clean and level surface is required for operation of the trailer mounted forklift equipment.

Clay Drainage is ideally off-loaded by forklift or by M.O.L vehicle.

Handling

Fittings in shrink-wrapped packs can be off-loaded in a similar manner to pipes. A solid surface is needed for operation of the trailer mounted forklift. Packs should be set down on a reasonably level, hard surface.

When mechanical off-loading is not required, it is the responsibility of the contractor to off-load the lorry. Arrangements should be made for a forklift of adequate capacity to be available in order to avoid delay.

All equipment should be regularly tested and certified to comply with the requirements of the Health & Safety Executive.

Storage

Ideally pipes and fittings should be kept in their original delivery packing, stored on level ground.

Couplings and lubricant should be stored in their packaging or containers in cool dark conditions until they are required to be used. Long term exposure to ultra-violet light may cause deterioration of the materials.

If a heavy frost is expected on site it is good practice to protect any building material items from frost damage by covering with a large tarpaulin.



Installation

Dismantling a Hepworth Clay pipe pack

Care should be taken when removing pipes from pipe packs.

See below or watch the video for the correct method for dismantling 100 and 150mm SuperSleve pipe packs:



Always ensure the pipe pack is on firm and stable ground.



When ready for use, cut all the safety strapping bands.

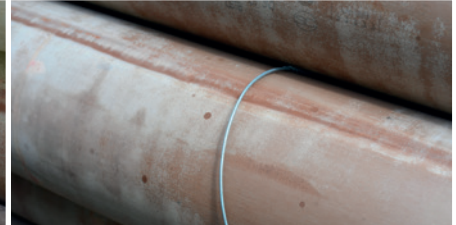

Do NOT cut the metal wires at any time on SuperSleve pipe packs.



For the top row: Lift down the pipe from the outside of the top row of the pipe pack.



Then lift down the opposite pipe.



Working inwards to maintain pack stability, slide the next three pipes out parallel and lift down.



The next row of six pipes are held by the metal wires.

- 2 people need to roll the two outside pipes to the top of the pipe pack at the same time



- Safely secure the metal wires out of the way
- Lift the top two pipes down and then the remaining four pipes



Continue to the base of the pack with the alternating layers in the same sequence.

The video is available on [youtube.com/WavinUK](https://www.youtube.com/WavinUK). Select the Hepworth Clay playlist.

Table 11 – Pipe pack dimensions and weights

Nominal Dia.(mm)	Length of Pipe (m)	No. per Pack	Approx. Weight of Pack (kg)	Dimensions of Pack (mm)		
				Height	Width	Depth
100	1.6	102	1540	1430	1100	1600
100	1.6	51	775	770	1100	1600
150	1.75	55	1715	1710	1090	1750
150	1.75	33	1099	1070	1090	1750
225	2.0	24	1450	1870	1200	2100
225	2.0	12	730	930	1200	2100
300	2.0	15	2080	2110	1180	2100
300	2.0	9	1252	1240	1180	2100
300	2.0	6	838	830	1180	2100

Installation: Pipe laying

Trench excavation and formation

Trench excavation

Trenches should not be excavated too far in advance of pipe laying and should always be kept to the specified design width. Excessively wide trenches increase the amount of excavation, bedding and backfilling, and may impose a load on the pipe in excess of the design load. Excavations for inspection chambers may need to be wider, but care should be taken to minimise their width and length.

Table 12 gives recommended trench widths. These are used to determine external loads on pipelines in narrow trenches.

Table 12 – Recommended trench widths

Nominal Diameter (mm)	Recommended Overall Trench Width (m)
100	0.45
150	0.6
225	0.7
300	0.8

The trench width should not be less than the pipe diameter plus 300mm

Trenches narrower than those shown above may impede the proper placing and consolidation of bedding material around the pipe and restrict working conditions in the trench during pipe laying.

Where a specific trench width is defined for the narrow trench design condition, this must be maintained vertically to a height of at least 300mm above the crown of the pipe.

Selected material and where required, subsoil and topsoil should be put aside for backfilling at a later stage. If applicable, buried services such as gas, electricity and water should be uncovered with extreme care.

The position of underground services should be established by checking records and the use of 'locators'. Mechanical excavators should not be used in the vicinity of underground utilities. All excavated material should be placed outside a 45° line drawn from the bottom of the trench. (Fig. 3)

Adequate trench support should be provided in all cases where the depth is greater than 1.2m and where necessary to ensure stability and safety. In unstable ground, such as moving sand or silt additional measures such as de-watering or consolidation by freezing or other means as may be necessary.

Trench wall supports should be appropriate to the pipe length being installed and method and location of excavation. The proximity of traffic, retaining walls or any other underground features should be established as they may require special support arrangements during the excavation.

Trenches should be kept free from water, where possible, and the trench formation should not be disturbed by foot traffic.

Trench formation

To ensure uniform support along the pipeline, it is essential to remove all hard or soft spots which may cause differential settlement, and replace them with tamped, selected backfill.

The important points to remember when forming and stabilising trenches are:

- The nature of the ground
- The depth of the trench
- The depth of water table and permeability of the soil. Ground water should be kept below the bottom of the trench by the use of suitable de-watering techniques, and the water level should not be allowed to rise before backfilling is complete
- The requirement for trench supports and selection of the system must consider the applied loads, services crossing and handling equipment required
- Removal of hard or soft spots
- The location of new and existing structures
- The influence of construction and surface imposed loads
- Material stacked near the trench
- The use of a mechanical excavator, its capacity and size of excavator bucket to ensure correct width of trench to comply with the design specification
- Working space to access the trench
- Weather conditions
- Timescale
- The finished trench bottom must be to the correct line and gradient.



Fig. 3

Excavated material

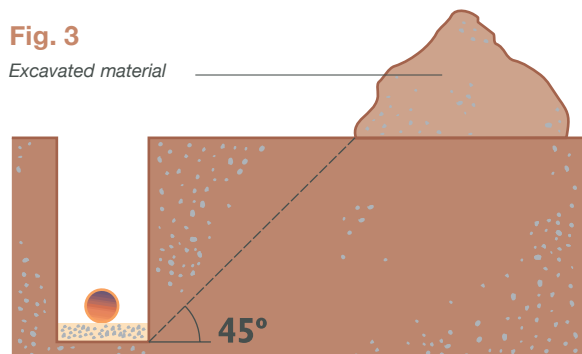

Installation: Pipe laying

Bedding requirements

General

Prior to the commencement of pipe-laying, the components should be inspected for damage during handling, transport and storage. All material and equipment required for carrying out the work in accordance with the specification and Health and Safety Regulations should be assembled.

The use of mechanical push-fit joints allows pipe laying to keep up with trench excavation and also allows testing to be carried out immediately after laying.

For pipe pack dismantling procedure, see page 95.

The following pages show standard pipe laying for vitrified clay pipes.

This section also includes a number of Technical Notes:

Technical Note 1 Laying pipes in soft ground

Technical Note 2 Laying pipes in waterlogged ground

Technical Note 3 Pipes passing through structures

Technical Note 4 Concrete bedding to pipes

Technical Note 5 Pipe under buildings

Technical Note 6 Pipes at shallow depths

Technical Note 7 Recycled aggregate

Protection of pipelines during construction

Until the final surface is placed, do not allow heavy traffic to cross the trenches. Use steel plates or suitable alternative to bridge the trench where such traffic is unavoidable.

Pipes near buildings

Trenches within 1m of load bearing walls should be filled with concrete at least to level of underside of the foundation. Where the distance is more than 1m from the wall, the concrete fill should be to a level below the underside of the foundation equal to the distance from the wall to the near side of the trench, less 150mm.

Fig. 4 – Laying pipes near buildings

When D is less than 1m, concrete fill to level of foundation bottom.

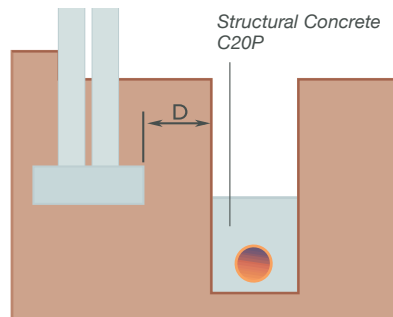

When D is 1m or more, concrete fill to within D-150mm of level of foundation bottom.

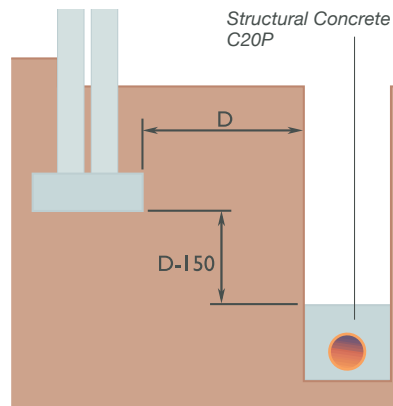

Pipe bedding

The load-bearing capacity of an installed pipeline depends on the construction of a suitable bedding and surround. The bedding should level out any irregularities in the trench formation and ensure uniform support along the pipe barrel.

Clay pipes are high strength rigid units which have been designed to carry applied loads with no deformation. Additional bedding and sidefill can, if necessary, enhance the pipes' load carrying capacity. Correctly sized granular materials which can be primary or recycled aggregates should be placed to the required level and extend the full width of the trench. Bricks or blocks must never be placed in the bedding material for setting the pipes to level.

Class D (Bedding factor 1.1)

Class D bedding is suitable for use where the trench bottom can be accurately hand-trimmed with a spade, supporting the pipe along its length. Coupling recesses should be made and the pipe barrel rested firmly on the trench bottom.

Class N (Bedding factor 1.1)

Class N bedding is suitable for use where the trench bottom cannot be accurately hand-trimmed with a spade. Excavate the trench to a depth of at least 50mm below the pipe, increasing this in rocky ground to 150mm. Form a bed for the pipe from as-dug, if suitable, or granular material, well compacted and covering the full trench width. Coupling recesses should be made and the pipe barrel rested firmly on its bedding.



Class F (Bedding factor 1.9)

Class F bedding is suitable for use where the trench bottom cannot be accurately hand-trimmed with a spade. Excavate the trench to a depth of at least 50mm below the pipe, increasing this in rocky ground to 150mm. Form a bed for the pipe from granular material, well compacted and covering the full trench width. Coupling recesses should be taken out and the pipe barrel rested firmly on its bedding. Any granular material used should be packed by slicing under the pipe with a spade.

Class B (Bedding factor 2.5)

Class B bedding resists higher loading conditions. The bedding material extends up to the mid-point of the pipe enabling the use of as dug material to complete the sidefill and initial backfill if suitable.

This bedding class provides greater structural support whilst providing an economic installation solution by returning more excavated sub-soils to the trench.

Class S (Bedding factor 2.5)

Class S bedding resists higher loading conditions. This bedding class is an alternative to class B bedding where the as dug material is unsuitable for use as sidefill and initial backfill.

Fig. 5 – Bedding

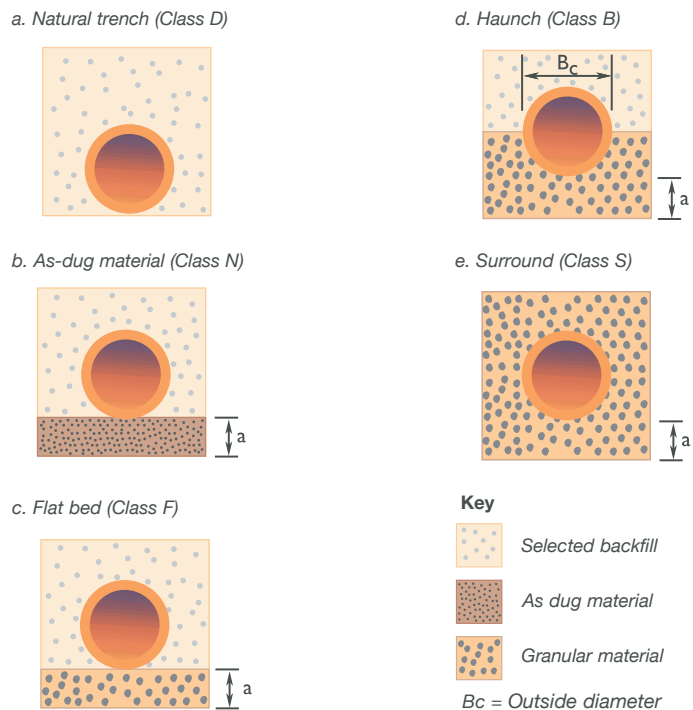

- a For sleeve jointed pipes minimum of 50mm or $1/6 B_c$, whichever is the greater under the barrel. In material containing rock or hard spots a minimum of 150mm or $1/4 B_c$ whichever is the greater.

Table 13 – Sizing of bedding material

Nominal bore of pipe (mm)	Size (mm) Single sized	Size (mm) Graded
100	10	
150	10, 14	14 to 5
225	10, 14 or 20	14 to 5 or 20 to 5
300	10, 14 or 20	14 to 5 or 20 to 5

Installation: Pipe laying

Laying pipes in soft ground (TN1)

Where the trench formation has little bearing strength and therefore will not support pipe bedding material effectively, it is necessary to provide a stable formation before pipe laying. Such conditions most commonly occur in peat, silty ground, soft to very soft alluvial clays, running sand, or in artificially filled ground.

Although trench formations are sometimes stabilised with concrete, this is unlikely to assure long-term stability in all cases, and a form of flexible bedding construction is the preferred method of dealing with this situation.

The trench formation and manhole base should be overexcavated by 600-800mm, depending on the bearing strength of the ground. Gravel reject material or small hardcore, less than 75mm, is then compacted in layers to form a firm trench bottom. A 50mm thickness of leanmix concrete is then placed as a blinding layer. The pipe is then laid on granular bedding material. These details are illustrated in Figure 6.

The pipe bedding construction requirements are calculated in the normal way, for example by using the CPDA's Bedding Tables or Simplified tables of external loads on buried pipelines. It is important that 'wide trench' design criteria are used because 'narrow trench' conditions cannot be guaranteed in this situation. The extra depth of granular bedding material shown in Figure 6, 150mm for sleeve-jointed pipes, rather than the usual 50mm, is required because of the hard nature of the constructed trench bottom. For a class 'F' bedding, selected backfill material is then placed to 150mm above the pipe and compacted before the main backfill is placed. Where class 'B' or class 'S' beddings are required, additional bedding material will either partially or wholly replace the selected backfill material.

Where groundwater exists at a level above the interface between the rejects and the new trench bottom, the procedure detailed in Laying pipes in waterlogged ground – Technical Note 2, page 100 should also be applied. The geotextile should surround both the material in the base of the trench as well as the pipe bedding material.

The use of a geotextile around the compacted material in the base of the trench will also assist compaction in exceptionally soft ground conditions, as well as limiting the movement of fines.

Fig. 6 – Class F bedding construction in soft ground

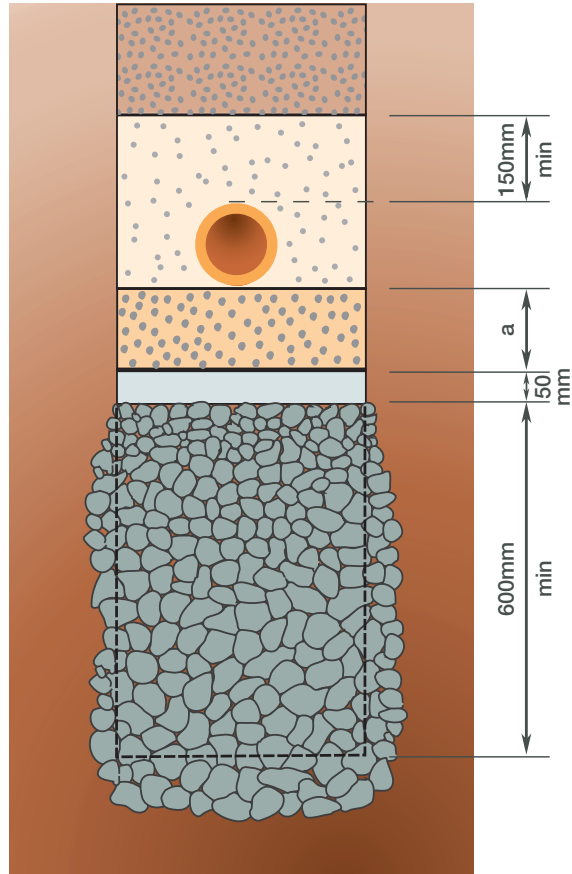

Note: Dimension 'a', the depth of the bedding material below the pipe, is 150mm.

Installation: Pipe laying

Laying pipes in waterlogged ground (TN2)

Moving groundwater at a level above trench formation in fine grained soils can reduce the support strength of pipe beddings. Granular bedding material encourages water movement and this washes fines out of the surrounding ground, causing a loss of support to the bedding and pipeline. This may occur particularly in peat, silty ground, soft to very soft alluvial clays, running sand or artificially filled ground.

The traditional method of dealing with this problem was to include a proportion of coarse sand in the bedding material in order to fill the interstices which might otherwise take up the fine material from around the trench. This limits the movement of fines, but the bedding material requires much more compaction than if it were single sized or graded.

A more effective method is to wrap the whole of the bedding construction, including any additional compacted material in the trench bottom as detailed for poor ground, in geotextile fabric as shown in Figure 7.

This will allow the movement of water through the bedding material, but will tend to prevent the movement of fine material, and retain it in the ground around the trench. In such conditions measures are also needed to prevent similar movement of fines under manholes. The geotextile construction should be continued around the outside of the manhole excavation and under any manhole bedding material. The specification for the geotextile, particularly the pore size, should be related to the nature of the fines in the ground, and specialist advice might need to be sought.

Prior to commencing pipe laying it is essential to satisfactorily dewater the trench formation. Any well point dewatering must also be suitably filtered to prevent continuous removal of fine sand and silts. Sump pumping from the end of the trench is not recommended even when filtered, as instability of the formation can arise.

Care should be exercised when using 'trench box' or similar trench support systems in waterlogged fine grained soils because the pipe and bedding are likely to be disturbed when the support is moved or removed. Backfilling should proceed progressively as the support system is removed.

Fig. 7 – Use of Geotextile material around pipe bedding in waterlogged ground

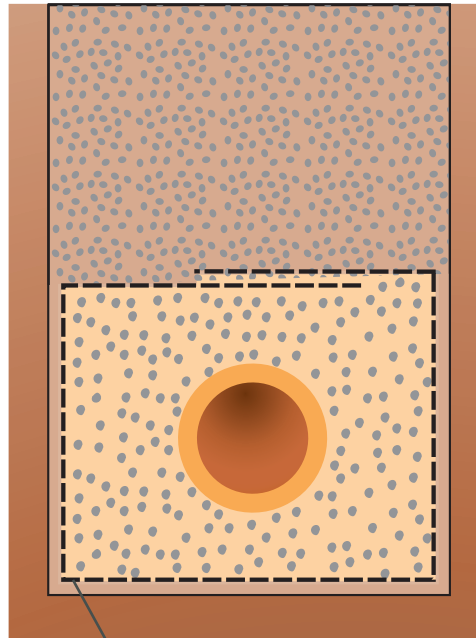

Geotextile wrapped over pipe bedding/surround

-  Main Back Fill
-  Pipe Bedding/surround Material

Installation: Pipe laying

Pipes passing through structures (TN3)

Where a pipeline is built into any structure differential settlement will take place. This occurs at any manhole, inspection chamber, groundbeam or concrete surround and must be allowed for in detail design.

A risk of a pipe failure occurring at this point may be obviated by providing a flexible joint close to the face of the structure, allowing for the joint to be properly made and to move freely. A short length 'rocker' pipe should be laid next before any full length pipes are used, as illustrated in Figure 8 and 9.

The first joint should be within 150mm of the face of the structure.

The length of the rocker pipe should be no longer than 600mm for pipe diameters up to and including 300mm.

Where very large differential settlements may be anticipated, the number of short length pipes should be increased. Shallow gradients should be avoided in this situation, in order to minimise the possibility of backfalls occurring.

The effects of differential settlement may also be overcome by the provision of a relieving arch or lintel over the pipeline as it passes through a structure as shown in Figure 9 (b).

A gap of not less than 50mm must be left around the pipe and effectively sealed to prevent the entry of gas, bedding material or rodents. This is not an easy requirement to fulfil.

Flexible joints should be incorporated close to the structure, even where this procedure is adopted.

Where a pipeline is to pass close under a groundbeam, the groundbeam may be treated as a lintel. The pipeline should be isolated from the groundbeam by, for example, a slab of expanded polystyrene of at least 50mm thickness placed under the groundbeam as illustrated in Pipelines under buildings – Technical Note 5, page 104.

Alternatively, where ground conditions are suitable, the beam may be lowered to incorporate the pipeline as a built-in structure. In both cases, flexible joints should be provided close to both sides of the beam, with the appropriate associated rocker pipes.

Fig. 8 – Plan view of typical inspection chamber

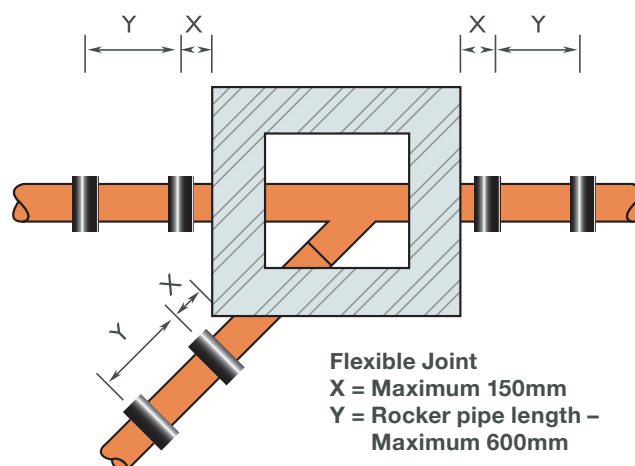
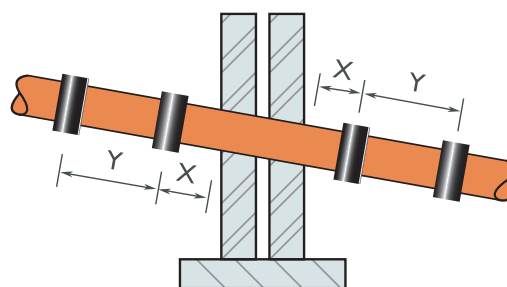
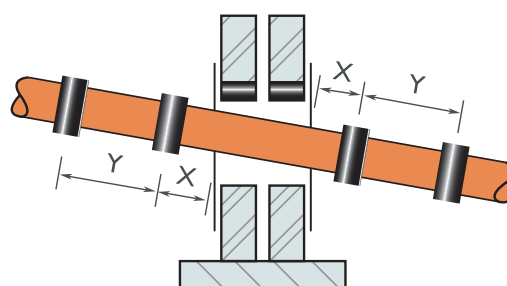

Fig. 9 – Diagrammatic sections showing pipes passing through walls



a. Pipe built-in to structure



b. Pipe through lintelled opening

Flexible Joint
X = Maximum 150mm
Y = Rocker pipe length - Maximum 600mm

Installation: Pipe laying

Concrete bedding to pipes (TN4)

Bedding or surrounding a pipe in concrete may be required in some cases. The indiscriminate use of concrete for pipe beddings can cause problems unless carefully specified procedures are adopted as set out in this Technical Note.

The trench formation should provide a firm foundation for the concrete bed or its value in strengthening the pipeline will be lost. It may therefore be necessary to seal or firm up the trench bottom before laying the concrete bedding using a blinding layer of weak concrete or granular material. It may also be necessary to excavate soft spots and compact in some more suitable material, such as granular bedding material or small hardcore.

It is important that the following minimum dimensions for concrete bedding or surround are used in order to ensure that the specified bedding factors are realised. Any concrete bed or surround should extend at least 150mm either side of the pipe. The depth of concrete below the pipe, and above the pipe for a surround, should be at least 150mm or one quarter of the outside diameter, whichever is the greater.

The flexibility of a pipeline bedded on or surrounded with concrete should normally be maintained by the provision of flexible construction joints through the concrete at each pipe joint.

Where more uniform support of the pipeline is found, the construction joints may be less frequent. However, it is recommended that they are no more than 5m apart.

These should be made from bitumen impregnated insulating board complying with BS EN 622-4, or other equally compressible material such as expanded polystyrene.

The board should be cut to fit the pipes, and placed at the face of sockets or at one end of sleeve joints.

Where large shear forces may be expected to occur at construction joints because of heavy imposed loads, it is preferable to omit flexible construction joints and to longitudinally reinforce the concrete bed to obviate possible excess shear forces causing pipeline failure.

Examples are on shallow pipelines under main roads or on very deep pipelines. However, it is necessary to introduce one flexible construction joint at least every 5m length, keeping the longitudinal reinforcement continuous, so as to avoid problems due to the expansion and shrinkage of the concrete. This construction joint should be positioned at the face of a pipe joint.

All concrete for pipe bedding should be of structural quality, minimum C20/25, and should be thoroughly compacted into place. Care should be taken in placing concrete so as not to move pipes or construction joints.

No load shall be applied within the 24 hour period immediately after the completion of placing the concrete, except for an uncompacted protective layer of selected backfill material. Mechanical compaction should not be used and traffic loads should not be imposed until at least 72 hours after completion of concreting. This is to allow the concrete to reach a high enough strength to resist backfill and compaction loads, usually quoted as 14 MN/m².

Unreinforced and reinforced concrete beddings and surround are illustrated in Fig. 10, page 103.

The use of concrete arches is not recommended because it is difficult to ensure adequate support at the sides of the pipes. Additionally, the width of the top of the concrete, rather than the outside diameter of the pipe, is used to calculate the load on the pipe/bed construction. This higher load can counterbalance the higher bedding strength of the arch or surround.

For reinforced concrete beds, the minimum transverse steel area should not be less than 0.4% of the area of the concrete in longitudinal section.

If the area of transverse steel is increased to 1.0% of the concrete area in longitudinal section in a concrete bed and surround both above and below the pipe, the bedding factor may be increased up to 4.8. This bedding factor has been derived from the 4.8 for a 1.0% reinforced concrete arch.

The area of vertical steel within the reinforced surround and longitudinal steel in bedding or surround is nominal for construction purposes, where flexibility at joints is maintained.

Fig. 10 – Plain and reinforced beddings and surrounds

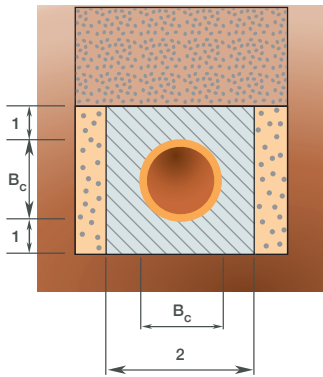

a. Unreinforced concrete surround. Bedding factor 4.5 (maximum diameter 600 mm). Reference: ASCE Gravity sanitary sewer design and construction [1]

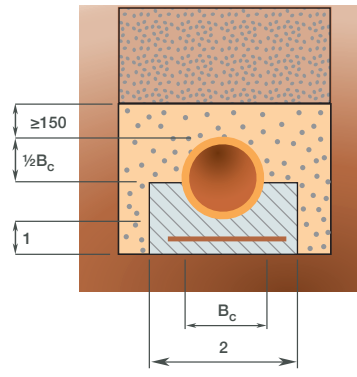

b. Reinforced concrete bed. Bedding factor 3.4 (0.4% steel)

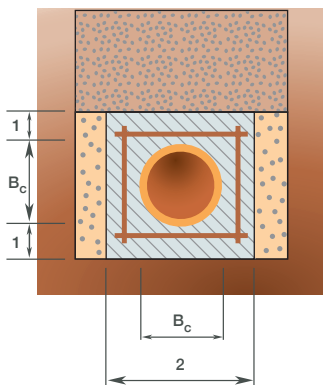

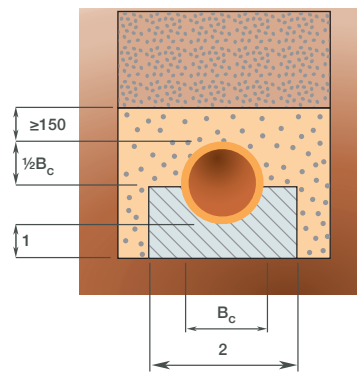

c. Reinforced concrete surround. Bedding factor 4.8 (4 × 1% steel). Reference: TRRL Simplified tables [2]



d. Unreinforced concrete bed. Bedding factor 2.6

Key

- 1** = The larger of $\frac{1}{4}B_c$ or 150mm
- 2** = The larger of $1\frac{1}{2}B_c$ or $B_c + 300$ mm
-  = Main backfill
-  = Selected backfill
-  = Structural concrete

[1] AMERICAN SOCIETY OF CIVIL ENGINEERS and WATER POLLUTION CONTROL FEDERATION. Gravity sanitary sewer design and construction, Reston, Virginia: ASCE Publications, 1982.

[2] YOUNG, O.C., BRENNAN, G. and M.P. O'REILLY. Simplified tables of external loads on buried pipelines. Transport and Road Research Laboratory, Department of Transport. London: HMSO, 1986.

Installation: Pipe laying

Pipelines under buildings (TN5)

Where a pipeline passes under a building, it is necessary to both protect it from any imposed loadings and ensure that the stability of the building is not impaired.

Where a pipeline has less than 300mm cover under a load-bearing floor slab, it should be surrounded with concrete integral with the slab. Ideally this should be poured at the same time as the floor slab. The concrete surround should be tied to the slab with nominal steel reinforcement placed vertically with turned over ends. If it is not possible to pour the concrete surround at the same time as the slab, the steel reinforcement should be included and used to tie two pours together. No provisions for flexibility within the concrete surround should be made, unless an expansion joint is included in the slab. A construction joint as described in Concrete bedding to pipes – Technical Note 4, page 102, should be included within the pipe surround at that point which must also be coincident with a pipe joint.

Additional flexibility should be incorporated into the pipeline as it leaves any concrete surround, as set out in Pipes passing through structures – Technical Note 3, page 101.

In normal stable ground conditions, and with 300mm or more cover to the pipeline beneath the slab, then a total granular surround can be used as the pipe bedding. Where the pipeline subsequently passes under or through the edge of the building, it should be treated as shown in Technical Note No. 3. It may be practicable to lower an edge-beam to incorporate the pipeline as a built-in structure, or it may be preferred to pass under the beam with minimum cover, treating it as a lintel.

These details are illustrated in Fig. 11.

Fig. 11 – Vitrified clay pipeline under typical building slab

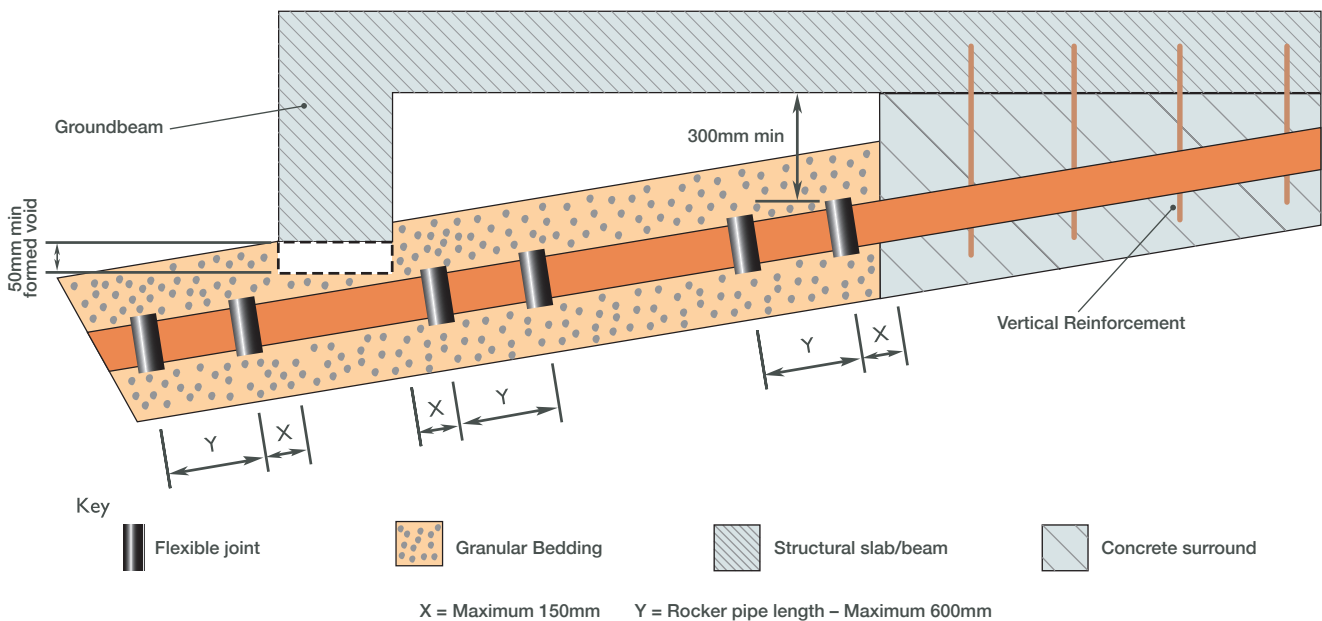

Installation: Pipe laying

Laying pipes at shallow depths (TN6)

Most specifications for drainage or sewerage pipelines contain similar general recommendations on minimum depths of cover, together with warnings that shallower pipelines require special protective measures to be taken.

Protection of shallow pipelines

Shallow pipelines may need to be protected by more than normal bedding and backfill materials, especially when laid at an early stage of a contract where the cover is less than that specified.

Two clear examples of this are:

1. When a sewer or drain is laid in a road which has only been brought up to formation level, where the pipe bedding has been designed assuming full depth of cover to finished road level.
2. Where building works are taking place close to a drain run previously laid to a specification suitable for 'fields and gardens' and the pipeline is subjected to unexpected loading due to delivery lorries, dumpers, fork lift trucks, etc.

Wherever possible, pipe laying should be the last construction activity, so as to be within the design conditions, otherwise the pipelines must either be isolated from site traffic by directing this away from pipe runs or temporarily bridging the trenches, or the pipes must be protected by stronger bedding constructions.

Taking into account the warnings given in various design tables for bedding construction, including those published by the CPDA, pipes can be safely laid using granular bedding without the need for a concrete bed or surround, provided that the effective depth of cover is at least 0.6m, the required bedding factors are achieved and there are no additional imposed loads.

The CPDA's Simplified Table for pipe beddings provides information on cover depths down to 0.4m for DN100 pipes, with an appropriate warning on their use.

Where the depth of cover is less than 0.6m, it is recommended that the pipeline is completely surrounded with structural quality concrete, minimum C20/25.

The flexibility of a pipeline bedded on, or surrounded with, concrete should normally be maintained by the provision of flexible construction joints through the concrete at pipe joints. These should be made from bitumen impregnated insulating board complying with **BS EN 622-4**, or other equally compressible filler material such as expanded polystyrene. The board should be cut to fit the pipes, and placed at the face of the pipe sockets or at one end of sleeve joints. The joint material should be at least 18mm thick.

This procedure allows for flexible movement of the pipe joints, while retaining the strength given by the concrete surround and should normally be carried out at every joint as shown in Fig. 12, particularly in building drainage applications.

Where more uniform support of the pipeline is found, the construction joints may be less frequent. However, it is recommended that they are no more than 5m apart. Further details of concrete surrounds are given in Technical Note No. 4.

An alternative method of protection is to use concrete slabs of sufficient strength to span the trench, as shown in Fig. 13.

Fig. 12 – Protection of a shallow pipeline

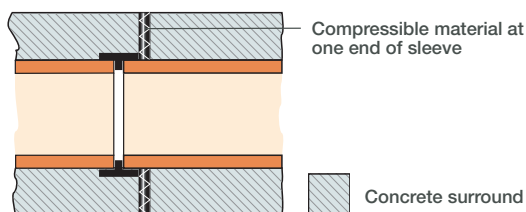

Sleeve jointed pipes in a concrete surround

The intention of this method of protection is to isolate the pipeline from imposed loading, particularly traffic loading, which is critical at shallow depths. In order to do this, the slab must be structurally capable of carrying the imposed load. In roads with a reinforced concrete slab construction, this may be easily accomplished by continuing the slab over the trench. Separate slabs may also need to be reinforced, except for example in gardens, when no wheel load is anticipated.

It is important that in all cases the slab spans the trench completely, bearing on the original ground on both sides, and does not simply rest within the trench. The width of bearing required will vary with the pipe diameter, trench width and ground conditions, but should not be less than 300mm.

It is advisable to make sure that any movement or deflection of the slabs does not load the pipeline by introducing a layer of compressible material, such as expanded polystyrene, immediately below the slab. The pipe should be bedded and surrounded in appropriate granular material in the normal way as shown in Fig. 13.

In all cases, backfilling should be carefully carried out as recommended in **BS EN 1610**. Where concrete backfill to trenches is demanded for early permanent reinstatement, either using lean mix or foamed concrete, care should be taken that this is not allowed to generate a high concentrated load on the pipes. It is therefore necessary to ensure that the concrete backfill is well supported by the trench sides. This can be achieved by the use of a stepped or battered trench. Concrete should not be placed between trench sheets which are subsequently removed since this would eliminate the friction between the concrete and the trench walls.

Fig. 13 – Protection of a shallow pipeline using a reinforced concrete slab

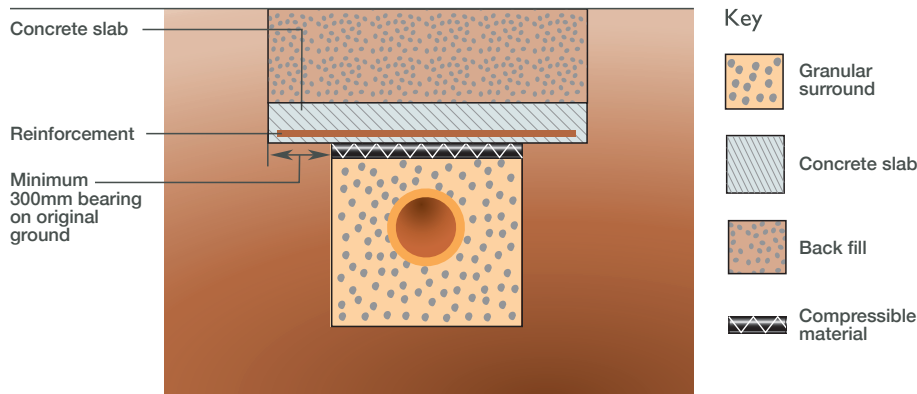

Installation: Pipe laying

Laying vitrified clay pipes on recycled material (TN7)

Recycled aggregates

Hepworth Clay has a long track record in the promotion, specification and use of recycled aggregates in drainage installations. The manufactured strength of clay pipes enables the safe use of recycled aggregates which contributes to improving the sustainability of a project without increasing cost and most importantly risk.

Primary aggregates are a finite resource, all sources have some level of associated environmental impact with quarrying or dredging. If recycled aggregates can be used instead, then the primary resources are preserved.

The inherent durability and strength of clay pipes means that recycled aggregates can come from a range of sources ideally starting with the most sustainable and least cost options first. Such as creating and using them on the same site to avoid transportation. Provided that the majority of contaminants can be removed, and minimum quality levels can be achieved during on-site processing an acceptable recycled aggregate can be produced. Hepworth clay pipes are more than robust enough to take full benefit of using recycled aggregates and can easily withstand variable and the variety of constituents and contaminants normally found in widely available recycled aggregates therefore can be specified and used in confidence.

Quality

High-quality recycled coarse aggregates are produced to BS EN 13242 Aggregates for unbound and hydraulically bound materials for use in civil engineering work and road construction. They will also conform to the Waste and Resources Action Programme (WRAP) Quality Protocol, Aggregates from inert waste. Each delivery to site should be supplied with a certificate confirming that each requirement has been complied with and that it has been tested with the aggregates end use in mind.

Suitable materials are those that have a high compaction fraction and have minimal contaminants and dust. (See Table 14). Any recycled aggregates will, upon inspection be seen to contain a number of materials such as crushed concrete aggregate, brick, glass and asphalt. (see image on next page).



Table 14 – Maximum recommended level of impurity (by mass)

Impurity	Maximum percentage by mass
Asphalt and tar	5
Wood	2
Glass	5
Sulphates. Acid soluble SO ₃	1
Other foreign materials	1 by volume if ultra-lightweight
Maximum recommended level of fines	
Fines	5
Masonry content (plaster/mortar)	5

Aggregate specification and sizing

Coarse aggregates shall comply with BS EN 13242 (clause 4.3.2 and 4.6) and the WRAP Quality protocol supporting documentation shall be provided with each delivery of materials to ensure that ongoing quality control is maintained.

Perform an on-site compaction fraction test, then confirm that the factor of safety remains within the original design parameters.

The maximum level of impurities shall be as table 14.

Hepworth Clay pipes and fittings shall use the aggregate sizing table (table 13 on page 98) relative to the nominal pipe diameter being installed.

Note: All external references listed at the end of this section contain slight differences between each document, which can make comparison difficult.

Compaction fraction test

Equipment

Open-ended cylinder, 150mm in diameter, (A DN150 pipe is suitable) approximately 250 mm long.

Metal rammer, with a striking face approximately 40 mm diameter and weighing between 0.8 kg and 1.3 kg. Steel measuring tape.

The test

Ensure that the moisture content of the sample does not differ from the bulk material at the time of its use and that a truly representative sample of the aggregate to be tested is taken. Mix approximately 50 kg of the aggregate to be tested with a shovel turning it over three times into a cone shape on a clean flat surface. Flatten the top of the cone then divide the aggregate into four quarters. Remove one pair of opposite quarters and remix the remaining pair back into a cone shape. Repeat this procedure until about 10kg of the aggregate remains.

Place the cylinder on a firm flat surface and gently pour the sample aggregate into it, loosely and without tamping.

Installation: Pipe laying

Laying vitrified clay pipes on recycled material (TN7)

When full, strike off the top surface level with the top of the cylinder and remove all surplus spilled material from the area. Lift the cylinder up clear of its contents and replace on a clean flat surface.

Pour approximately one quarter of this aggregate back into the cylinder and tamp vigorously with the metal rammer until no further compaction can be obtained. Repeat with the second, third and fourth quarters, tamping each layer as before, making the final surface as level as possible. Do not tamp so vigorously as to break the aggregate being compacted.

Determination of compaction fraction

Measure from the top of the cylinder to the surface of the compacted aggregate using a steel tape and divide this measurement by the height of the cylinder to obtain the compaction fraction of the material being tested.

Compaction fraction result	Compaction fraction grade
< 0.15	High
0.15 – 0.30	Medium
> 0.30	Low

Bedding factors for use with recycled aggregate

The compaction fraction test is quick and easy to perform on site, it provides a reliable and repeatable determination of the level of structural support that any aggregate can provide. Additionally, levels of contaminants such as asphalt, wood, plastics and plaster should be low (see table 14, page 107).

High Compaction Fraction

Where the compaction fraction is equal to or lower than 0.15, demonstrating a level of structural support similar to primary aggregates, then normal bedding factors should be used, where $F = 1.9$, $B = 2.5$ and $S = 2.5$. (see fig 2, page 90).

Medium Compaction Fraction

Where the compaction fraction is between 0.15 and 0.30, highlighting a reduced structural capacity of the aggregate, then a corresponding reduction should be taken to use lower bedding factors for the same bedding class, where $F = 1.5$, $B = 1.9$ and $S = 2.2$.

Low Compaction Fraction

Where the compaction fraction is greater than 0.30 the aggregate provides a low-level of structural support, this aggregate should only be used for bedding class where $D = 1.1$, $N = 1.1$ and be thought of as offering similar structural support as native sub-soils.



All, national (BS) European (EN) and international (ISO) standards are subject to a periodic review. This is to ensure that they are updated with new developments and correctly cross reference other recently updated standards.

NB: Full titles can be found on the following page.

BS EN 1295-1 has been the drainage engineers structural design manual for underground pipelines since 1997 (as amended, now withdrawn). This document gave the basic principles of the nationally established methods of design, and the United Kingdoms' detailed method of design was contained within annex (B.1.12).

However, in April 2019 an updated version of BS EN 1295-1 was published and annex (B.1.13) now refers to BS 9295 Guide to the structural design of buried pipelines. BS 9295 was revised in February 2020 and will become the United Kingdoms' nationally established method of design.

BS 9295 is now a more comprehensive document containing new guidance for the specification and use of recycled aggregates (Annex A.22) – the main requirements of which, relating to vitrified clay pipes, are detailed in this technical note (TN7).

Should you require further information or guidance on how to specify and use recycled aggregates please contact us on 0800 038 0088 or email drainage@hepworth.co.uk

Example of 10mm single sized recycled aggregate

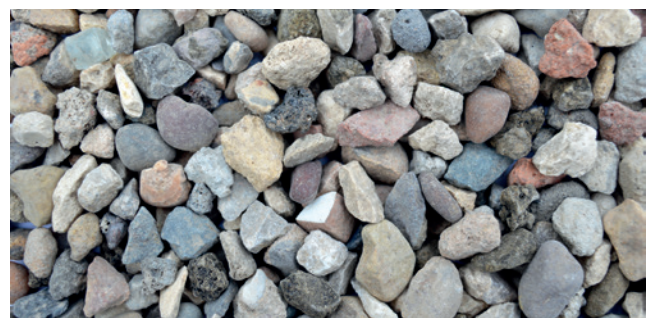

Further sources of information regarding the specification of recycled aggregates and pipe bedding can be found in the following documents. Where documents are undated, the current version should be used. Search BSi. shop for confirmation of the date of the current document.

- BS EN 1295-1: Structural design of buried pipelines under various conditions of loading. General requirements.
- BS 9295: Guide to the structural design of buried pipes.
- BS EN 1610: Construction and testing of drains and sewers.
- WIS 4-08-02: Specification for bedding and sidefill materials for buried pipelines.
- IGN 4-08-01: Bedding and sidefill materials for buried pipelines.
- Ofwat's Code for Adoptable Sewers – Appendix C, Design Construction Guidance.
- Approved Document H Drainage and waste disposal.
- MCHW Volume 1 Specification for Highway Works Series 500. Drainage and Service Ducts.

Further sources of information regarding the production of recycled aggregates for pipe bedding can be found in:

- BS EN 13242:2002+A1:2007 Aggregates for unbound and hydraulically bound materials for use in civil engineering work and road construction.
- PD 6682-6:2009+A1:2013 Aggregates. Aggregates for unbound and hydraulically bound materials for use in civil engineering works and road construction. Guidance on the use of BS EN 13242.
- WRAP Quality Protocol. Aggregates from inert waste. End of waste criteria for the production of aggregates from inert waste.

Installation: Pipe laying

HepLine

For purposes of surface water collection and conveyance, lay the pipe with holes upwards and cover with filter material (minimum particle size say 14mm) to a depth appropriate to the particular installation and circumstances. Where additional strength is required, selection of bedding should be determined by reference to the section of the design tables relative to pipe size and strength.

HepLine pipes can also be used to effect dispersal of surface water or septic tank effluent by laying with the rows of holes in the lower section of the barrel.

See Crushing Strength Table 2, page 15.

See page 51 for HepLine data on hole size and perforation area.

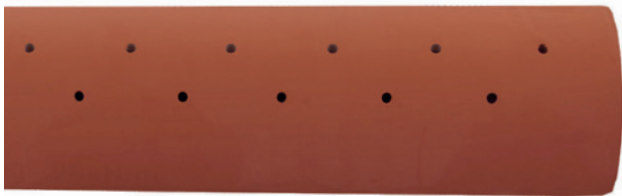
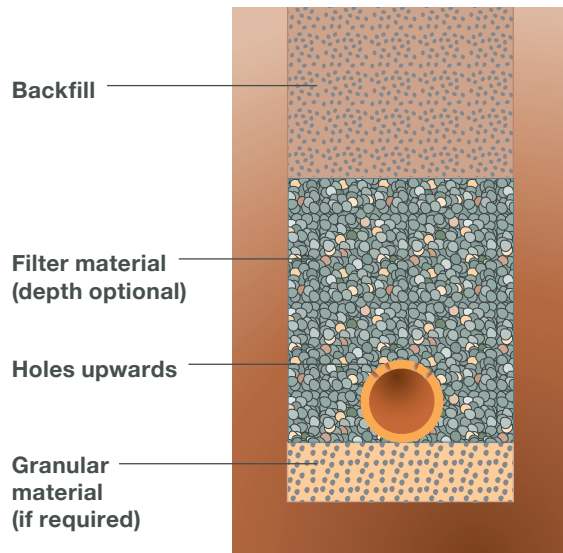
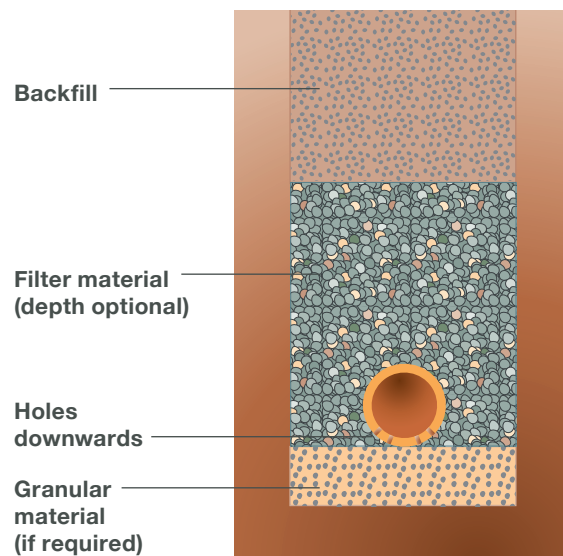

Fig. 14 – HepLine trench details

a. Collection system



b. Dispersal system



Installation: SuperSleeve

Vertical connections

Connection of internal waste pipe

Waste pipes can be connected to below ground drainage using an internal drain connector, S/S460 for 32/40mm waste pipes and S/S462 for 50mm waste pipes. For typical connection detail see Fig 15.

Fig. 15 – Connection of internal waste pipe

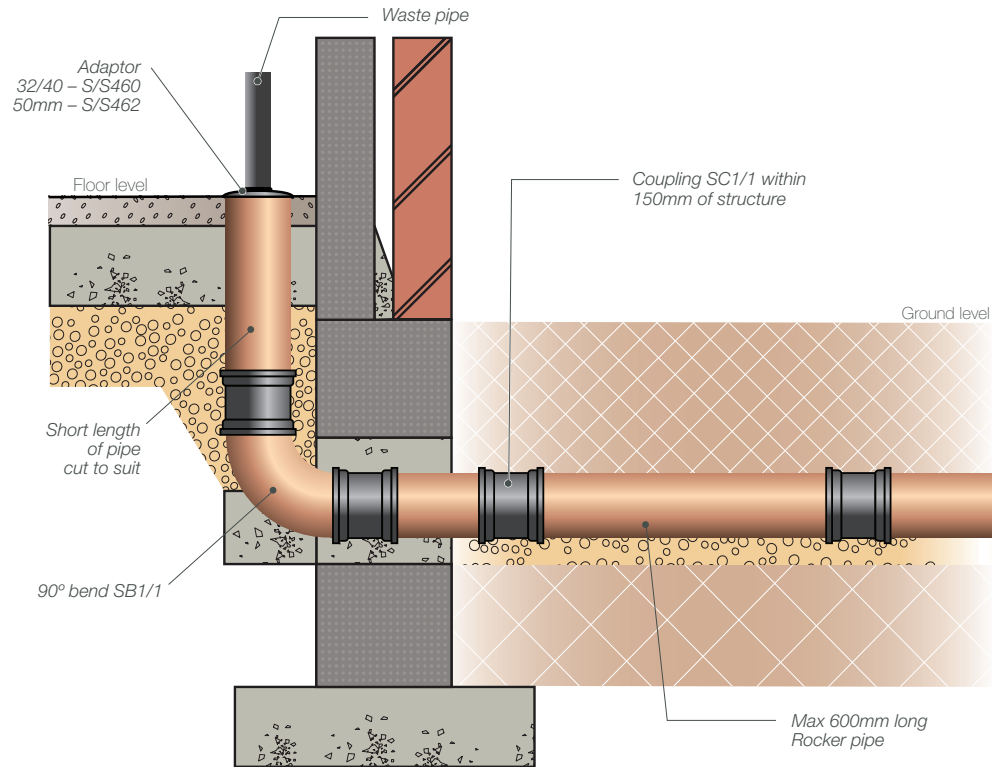

Connection of external rainwater pipe

Internal rainwater adaptors S/4A06B and S/4A06C are suitable for connecting 68mm round and 65mm square downpipes to 100mm SuperSleeve. Alternatively, a universal rainwater adaptor (SA11) could be used.

The SA11 fits over the pipe spigot and will accept round or square rainwater pipes up to 76mm.

Fig. 16 – Connection of external rainwater pipe

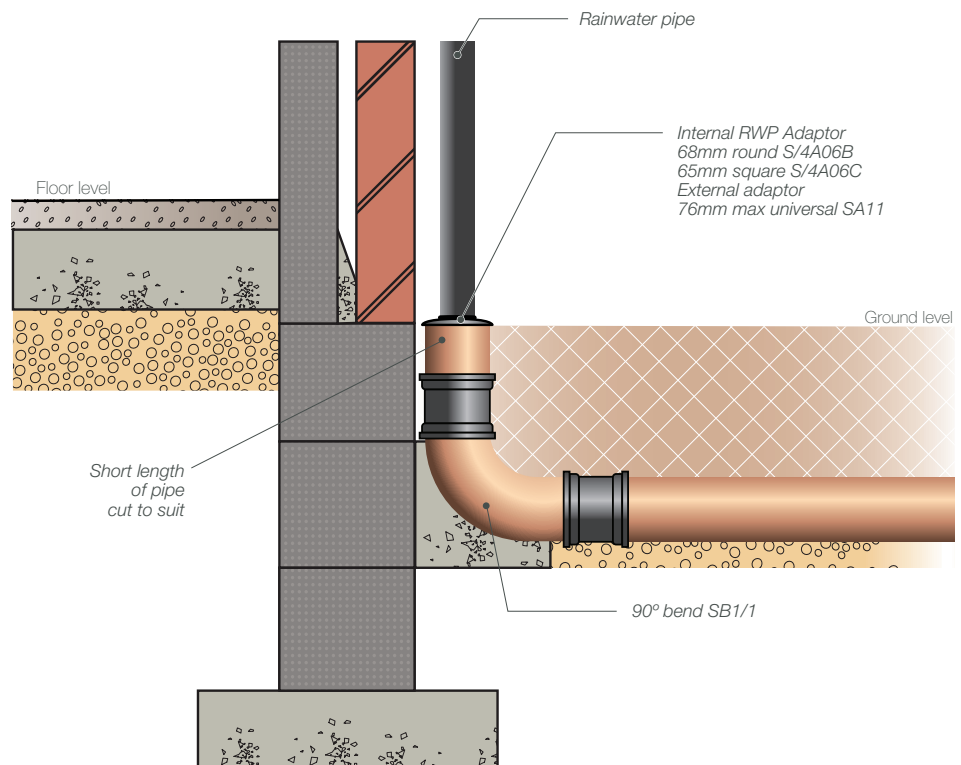

Installation: SuperSleeve

Vertical connections

Connection of 110mm internal rainwater/soil pipe

The SA9 adaptor coupling is suitable for connecting both 110mm PVC-U soil pipes and rainwater pipes to a 100mm SuperSleeve rest bend (SBR1). See Fig 17. Alternatively, a 110mm PVC-U rainwater pipe can be connected to a 100mm SuperSleeve 90° bend (SB1/1).

Fig. 17 – Connection of 110mm internal rainwater – soil pipe

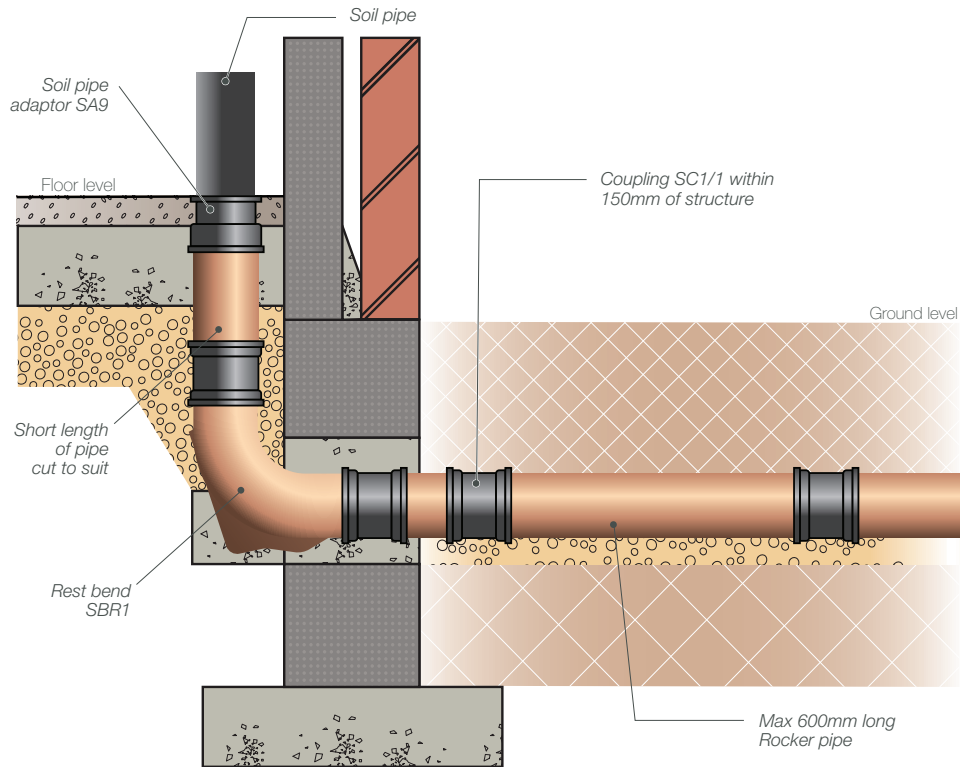

Installation: SuperSleeve

Telescopic Rest Bend

The Hepworth Clay Telescopic Rest Bend maintains an effective connection and seal between above and below ground drainage in areas where either ground settlement or clay heave is anticipated.

Benefits

- Available in two diameters: 100mm and 150mm
- For connecting 160mm soil pipes, 110mm soil pipes, rainwater pipes and waste pipes under buildings
- Connects to any common soil or waste system
- For 100mm dia. bends: up to 180mm of vertical telescopic movement can be accommodated
- For 150mm dia. bends: up to 230mm of vertical telescopic movement can be accommodated
- Couplings are heat shrunk together and onto the rest bend, forming a single unit

Product information

Product Code SBRT1 (100mm) and SBRT2 (150mm)

Key	Dimensions	(mm)	
		SBRT1	SBRT2
H	Overall height	545	635
N	Depth to invert	305	345
T	Telescopic movement	180	230
D	Nominal diameter	100	150

The diagram below illustrates a typical connection using a Telescopic Rest Bend.

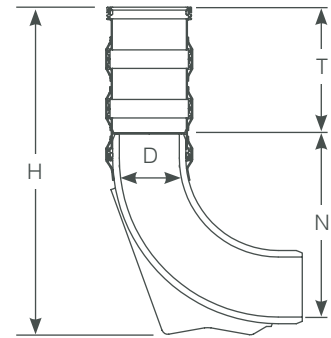
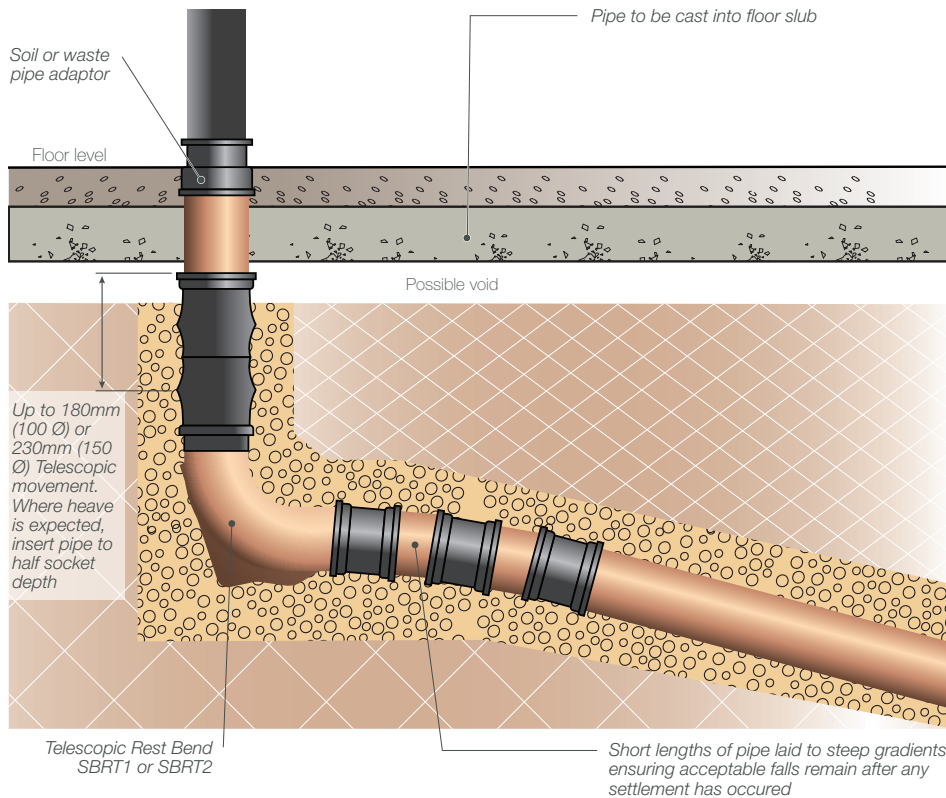

Fig. 18 – Telescopic Rest Bend installation



Installation: SuperSleeve

Rainwater and waste connections – Gullies

There are several gully options available for connecting waste or rainwater pipes to a below ground drainage system. The selection of the correct gully will depend on the diameter and shape of the waste or rainwater pipe, the need for rodding access and the security of the grating.

Below are three options which are all trapped and roddable.

Inlet Gully (SDG3/1)

The inlet gully comes complete with a removable dip tube trap, which when removed allows ease of access for rodding and the removal of debris. With 360° rotation between the hopper top and base, the outlet can be adjusted to take the best design line. The grating is hinged and fixed with two steel screws and can be replaced with a metal grating (SDG2/5) or a cover plate (SDG2/4), if required. The gully can accept waste pipes or rainwater pipes up to a maximum 68mm round or 65mm square, Fig 20.

Fig. 20 – Inlet Gully SDG3/1

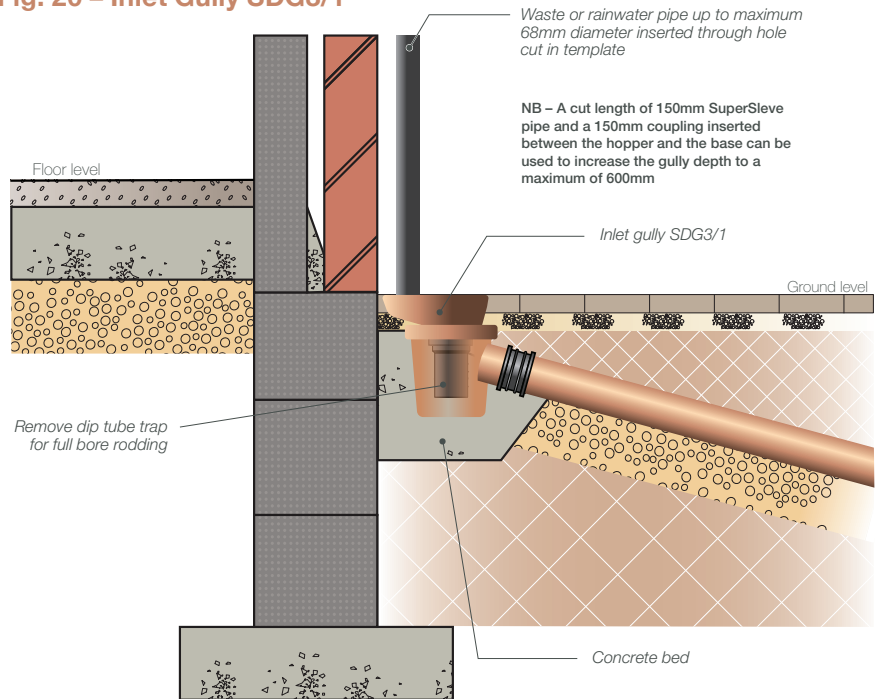

Access Gully (SG3/1)

Supplied complete with a polypropylene bridge and grid, the access gully can accept rainwater pipes up to 110mm round or 100mm square. The loose plastic grid at the front of the gully can be replaced with an alloy hinged grating and frame (IH1) or an alloy cover plate and frame (IS1), if required. For other grating options, see page 34.

Fig. 21 – Access Gully SG3/1

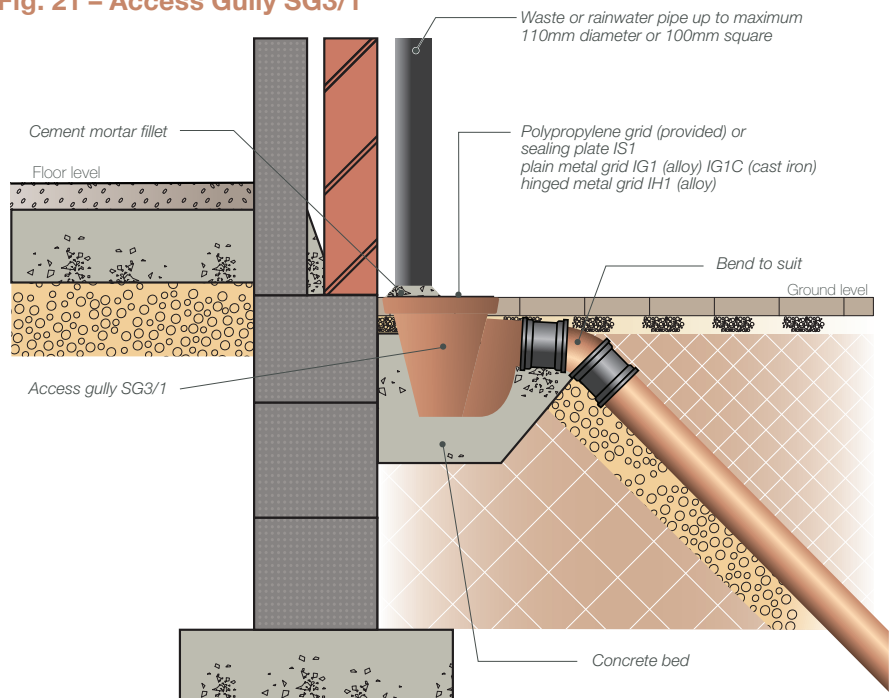

Square Gully (SG2/1)

A small compact gully supplied complete with a polypropylene grating. The bars in the grating can be removed using a small fine toothed saw to give a neat entry for waste or rainwater pipes up to a maximum 68mm round or 65mm square.

Fig. 22 – Square Gully SG2/1

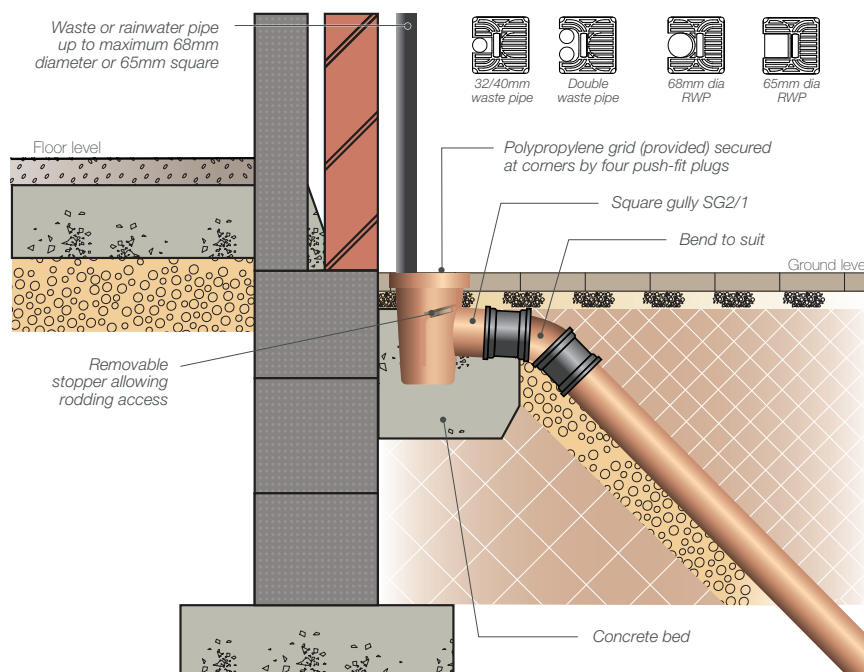

Paved Area Gully

The paved area gully is a compact, trapped, fully roddable gully with a 100mm diameter push fit outlet. The hinged polypropylene grating is fixed to the frame with two steel screws and can be replaced with a metal grating (SDG2/5), if required. The flanged frame allows the specified surface material (pavers, slabs etc) to be neatly finished against the frame edge. The gully is intended for use in hard landscaped areas inaccessible to vehicles. See Fig 23.

Fig. 23 – Paved Area Gully SDG2-1

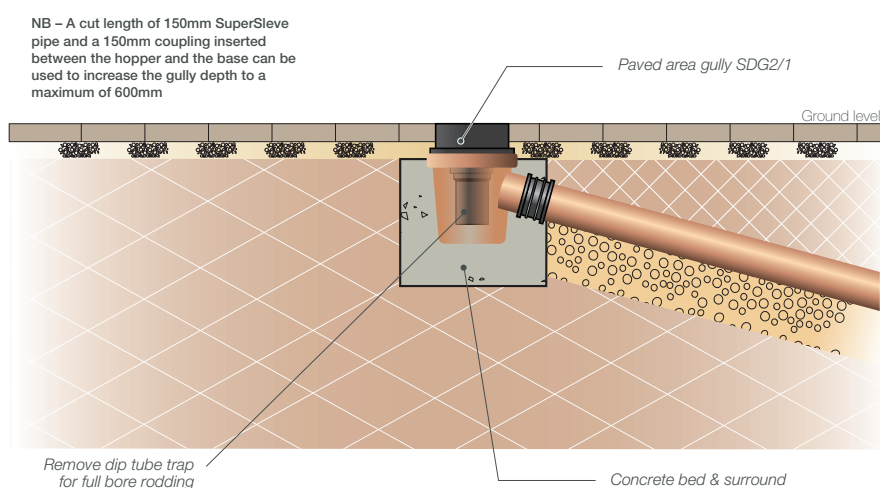

Installation

- When excavating for the gully, allow an additional 100mm under the unit and 150mm around the unit
- Bed and surround the gully with suitable concrete, up to the underside of the 100mm outlet
- Connect the gully to the branch drain
- Place concrete around the gully until it is 20mm above the flange running around the square cover and frame
- Installation is completed by applying the specified finish which can be taken up to the edge of the plastic frame

Installation: SuperSleve

Yard Gully

The trapped roddable 225mm diameter yard area gully is available with either a 100 or 150mm diameter outlet and comes complete with either an A15 or B125 loading class grating. The ductile iron hinged grating is housed in a polypropylene frame and is held in place with two steel screws. See Fig. 24.

Installation

Stage 1

- Place the grating and frame onto the gully top and mark the level of the underside of the frame on the gully
- Place the gully in position to proposed finished levels, the outlet can be rotated to point in any direction in relation to the frame
- If the gully is against a kerb or wall remove the flange on that side of the frame

Stage 2

- Remove the grating and frame and backfill around the base of the gully with compacted as dug, granular material or concrete
- Cast a 225mm deep concrete collar up to the mark on the gully body
- Place the grating and frame in position whilst the concrete is wet, making sure that the frame is fully supported by the concrete

Stage 3

- Installation is completed by applying the specified finish which can be taken up to the edge of the plastic frame
- The combined filter and silt bucket can then be added to facilitate cleansing

Fig. 24 – Yard Gully

N.B. The depth of the gully can be increased by up to 300mm by fitting a 225mm coupling SC1/5 and a 300mm high raising piece SP030/5 between the frame and the gully body.

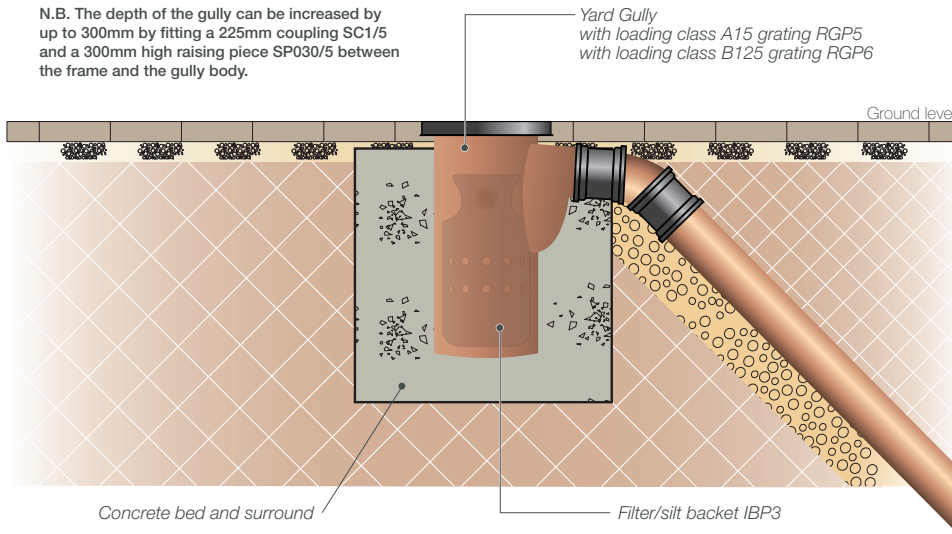

Installation: SuperSleve

Square Top Rodding Point

This fitting permits rodding with traditional rods, into a drain in the direction of flow, at an entry angle of 45° to the horizontal. The top surface of the rodding point should be set flush with the finished ground level. The fitted coupling allows direct connection to 100mm SuperSleve pipe and descends at 45° to connect via a SuperSleve 45° bend (SB2/1) or an oblique junction (SJ1/1), in the direction of flow. See Fig. 25.

Fig. 25 – Square Top Rodding Point

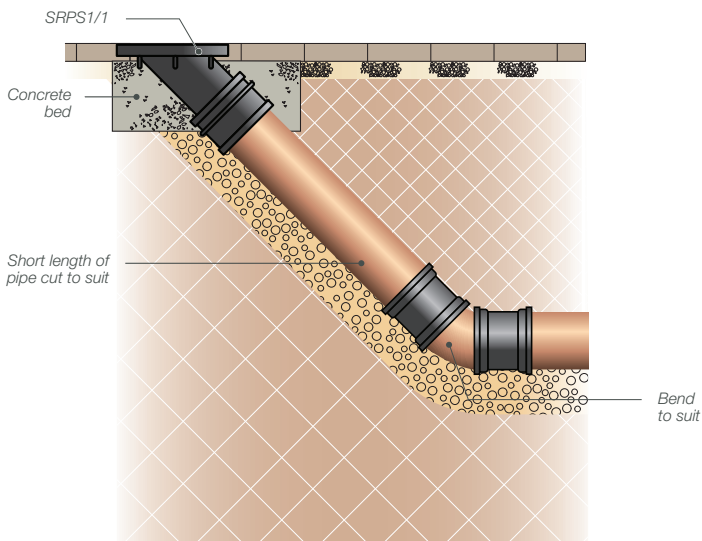

Installation: Chambers

Mini Access Chamber (MAC)

Typical Installation

The following is a typical summary of the installation procedure required to install the Hepworth Clay 300mm diameter MAC.

The MAC may be installed in the same minimum trench width as required for standard 100mm drainage pipework. NO extension of trench width is required.

All elements are lightweight: may be handled/installed by a single person.

Preparation

- Prepare and compact 100mm regulating bed of 'as dug' or granular material in trench bottom

Positioning/ connection

- Position Base on regulating bed. Check outlet is facing in the correct direction
- Ensure all inlets/outlet are free from dirt or grit
- Remove stoppers from side branches if required
- Use standard jointing sequence to connect 100mm SuperSleeve pipes to inlets/outlet
- The MAC is also available as base only, together with raising pieces with integral seals for assembly on site
- Where a chamber is being built-up on site, push-fit the first raising piece (shaft) onto the base
- Continue with other raising pieces as required, total depth not to exceed 0.6m
- The last raising piece (shaft) can be cut to suit the finished ground level using a fine toothed saw

Base layout

- The main through channel **MUST** be used
- Bends up to 45° may be used on any inlet or outlet
- Where chambers are positioned on 90° corners, always use the main channel by fitting a 45° bend (SB2/1) on inlet and outlet

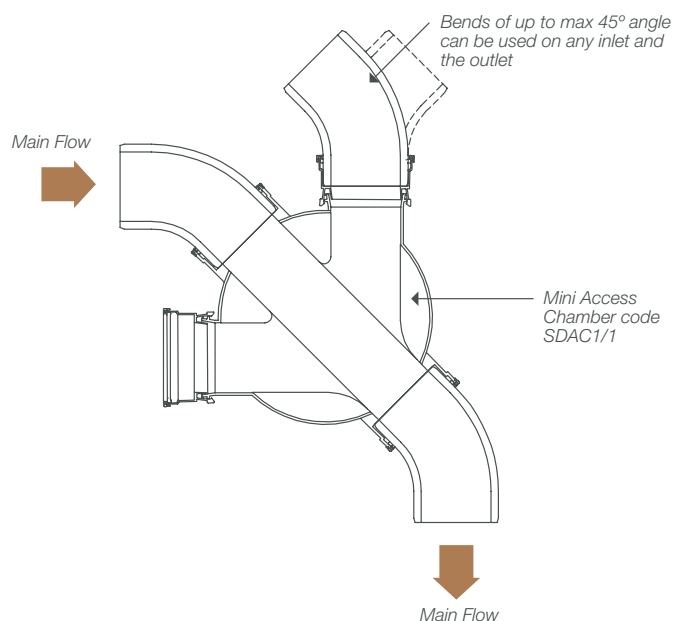
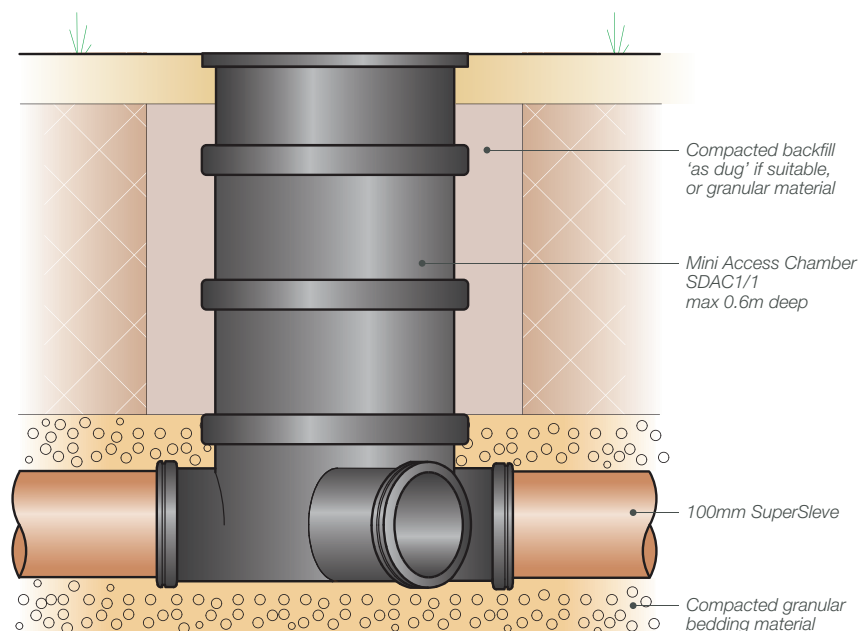

Fig. 26 – Installation detail – domestic gardens



Backfill trench

- Before starting backfill, cover top of chamber to prevent ingress of dirt or grit
- Backfill in 150mm layers of selected as-dug or granular material, well compacted, as work proceeds
- Precautions must be taken to protect the chamber from damage by construction site traffic
- Backfill to formation level. Then trim shaft to required height using fine toothed saw

NOTE: If finished ground level is not yet known, leave shaft proud of surface and keep covered and secure until final completion.

Cover and frame installation

For domestic gardens – see Fig 26.

- Trim shaft section at last stage of construction. Ensure unit is at correct height
- Prepare cover and frame for installation on chamber
- Push-fit the cover and frame assembly onto the shaft
- The cover is secured to the frame by four screws

For domestic paths / patios – see Fig 27.

- Lay 150mm thick slab of pre-cast or in situ concrete around top of chamber
- Prepare cover and frame for installation on chamber
- Push-fit the cover and frame assembly onto the shaft
- The cover is secured to the frame by four screws

Fig. 27 – Installation detail – domestic paths/patios

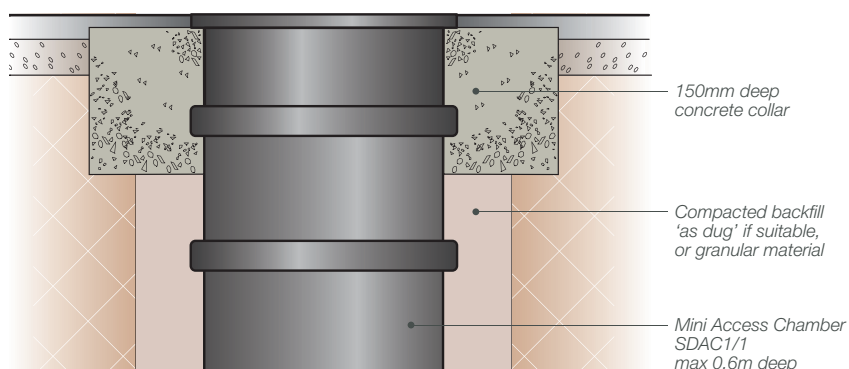

Installation: Chambers

Polypropylene Inspection Chambers (PPIC)

Typical Installation

The following is a typical summary of the installation procedure required to install the Hepworth Clay 475mm diameter PPIC.

All elements are lightweight: may be handled/installed by a single person.

Preparation

- Prepare and compact 100mm regulating bed of 'as dug' or granular material in trench bottom

Positioning/ connection

- Position chamber on regulating bed. Check outlet is facing in the correct direction
- Ensure all inlets/outlet are free from dirt or grit
- Remove stoppers from side branches if required
- Use standard jointing sequence to connect 100mm or 150mm SuperSleve pipes to inlets/outlet
- Both 100mm and 150mm chambers are available as a base only, together with raising pieces and sealing rings for assembly on site
- Where a chamber is being built-up or extended on site, locate the longer lip of the sealing ring on the inside of the rim of the chamber
- Lubricate the inside of the socket of the raising piece and position centrally over the located seal and hold in place for 10 to 15 seconds
- Continue with other raising pieces as required, total depth not to exceed 1.2m
- The last raising piece (shaft) can be cut to suit the finished ground level using a fine-toothed saw

Base layout

- The main through channel MUST be used
- Bends up to 45° may be used on any inlet or outlet
- Where chambers are positioned on 90° corners, always use the main channel by fitting a 45° bend on inlet and outlets

Backfill trench

- Before starting backfill, cover top of shaft to prevent ingress of dirt or grit
- Backfill in 150mm layers of selected as-dug or granular material, well compacted, as work proceeds
- Precautions must be taken to protect the chamber from damage by construction site traffic
- Backfill to formation level. Then trim shaft to required height using fine toothed saw

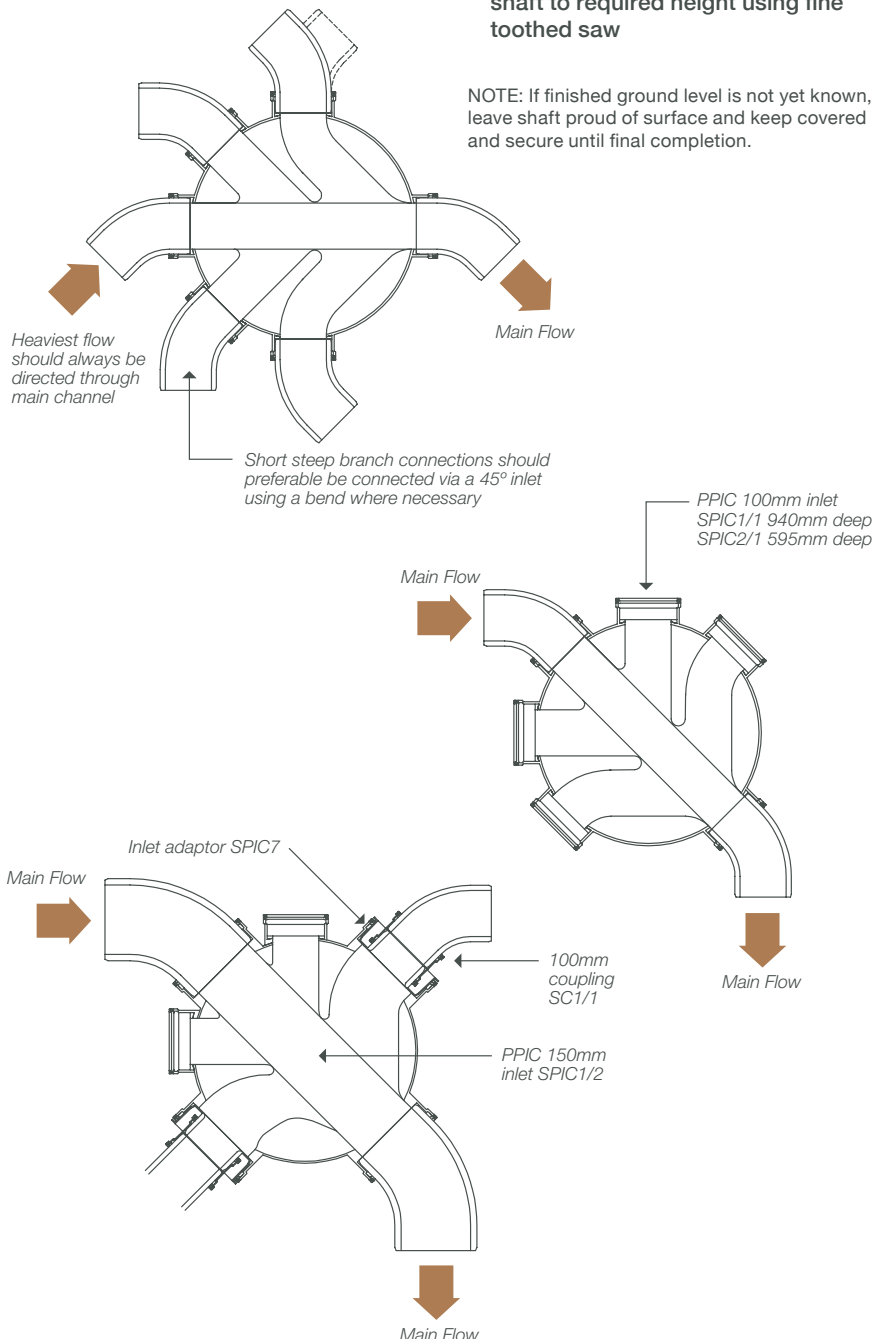

Cover and frame installation

For domestic gardens – see Fig 28.

- Trim shaft section at last stage of construction. Ensure unit is at correct height
- Prepare selected cover and frame [SPK8, SPK10 or SPKS8] for installation on chamber
- Position the cover in the secured frame
- The SPKS8 cover is secured to the frame by four screws.

Fig. 28 – Installation detail – domestic gardens

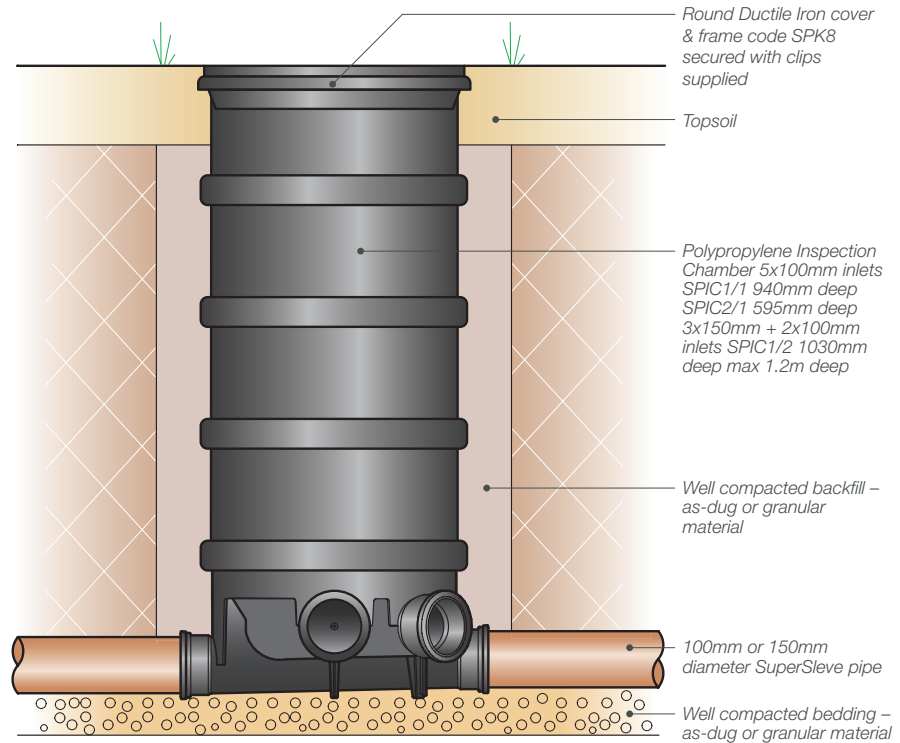

For domestic paths and patios – see Fig 29.

- Leave top 150mm of chamber clear of backfill
- Lay 150mm thick slab of pre-cast or in situ concrete around top of chamber
- Prepare selected cover and frame [SPK8, SPK10 or SPKS8] for installation on chamber
- Secure the frame to chamber using security clips supplied
- Position the cover in the secured frame
- The SPKS8 cover is secured to the frame by four screws

Fig. 29 – Installation detail – domestic paths/patios

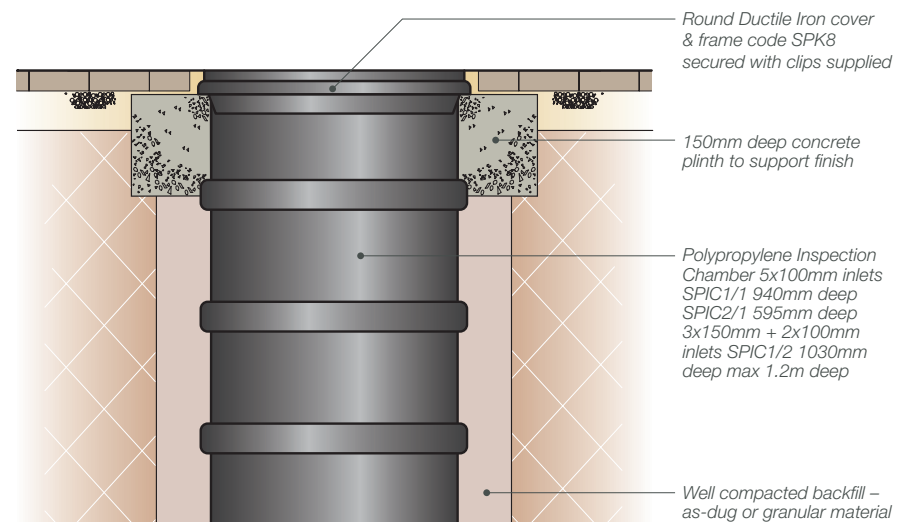

Installation: Chambers

Polypropylene Inspection Chambers (PPIC)

Cover and frame installation – cont.

For B125 applications subject to loading up to 125kN (12.5 tonnes) – see Fig 30.

- Trim shaft section at last stage of construction. Ensure unit is at correct height
- Lay 225mm thick slab of pre-cast or in situ concrete around top of chamber
- Prepare cover and frame (SPK9) for installation onto chamber
- Secure the frame to chamber using security clips supplied
- Position the cover in the secured frame

Fig. 30 – Installation detail – domestic driveways

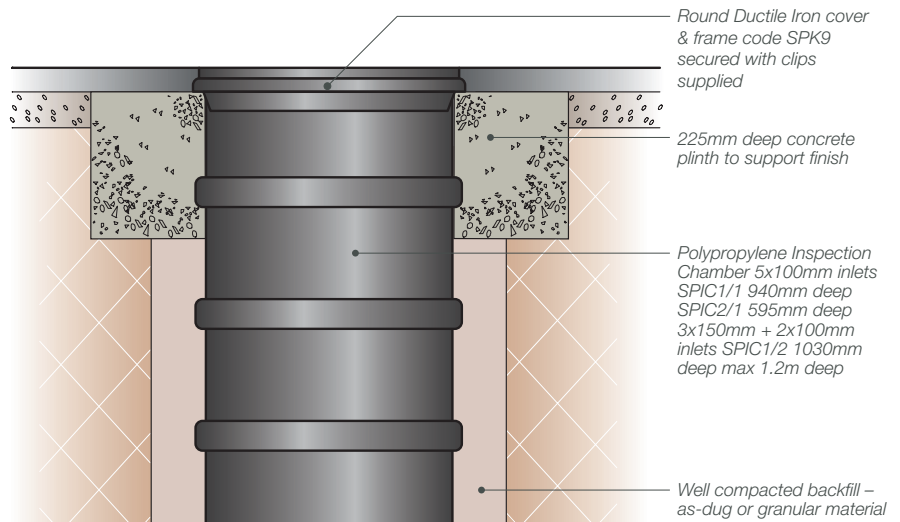

Installation: Chambers

Range 450 Inspection Chamber

Typical Installation

The following is a summary of installation procedures following selection of a suitable Range 450 base for the required number of inlets.

Excavation

- Take precautions against trench collapse

Preparation

- Prepare and compact 100mm regulating bed of granular material in trench bottom

Positioning/ connection

- Position base on regulating bed. Check outlet is facing downstream
- Use standard jointing sequence to connect 100mm or 150mm pipes to inlets/outlet. Push stoppers into any unused inlets

Base layout

- The main through channel **MUST** be used
- Bends up to 45° may be used on any inlet or outlet
- Where chambers are positioned on 90° corners, always use the main channel by fitting a 45° bend on inlet and outlet

Backfill

- Using same material as bedding, backfill around base in 150mm layers up to underside of shaft socket. Ensure inside of base is free of debris

Preparing shaft

- Cut corrugated shaft to approx. invert depth of chamber.
RECOMMENDATION: leave extra 300mm depth to allow for possible final site changes
- Locate sealing ring between 2nd and 3rd ribs from shaft bottom. Ensure ring is seated correctly and not twisted
- Clean inside of base socket and lubricate this entire area
- Position shaft and manually push home

Backfill trench

- Before starting backfill, cover top of chamber to prevent ingress of dirt or grit

Trim shaft / fit restrictor access cap

- Trim shaft to required height using fine toothed saw

NOTE: If finished ground level is not yet known, leave shaft proud of surface and keep covered and secure until final completion.

- When shaft trimmed to final height, locate sealing ring between 2nd and 3rd ribs from shaft top. Ensure ring is seated correctly and not twisted
- Lubricate inside of the restrictor cap, position over top of shaft, and push home

Fig. 31 – Typical installation domestic detail: Range 450 Inspection Chamber. Type 3

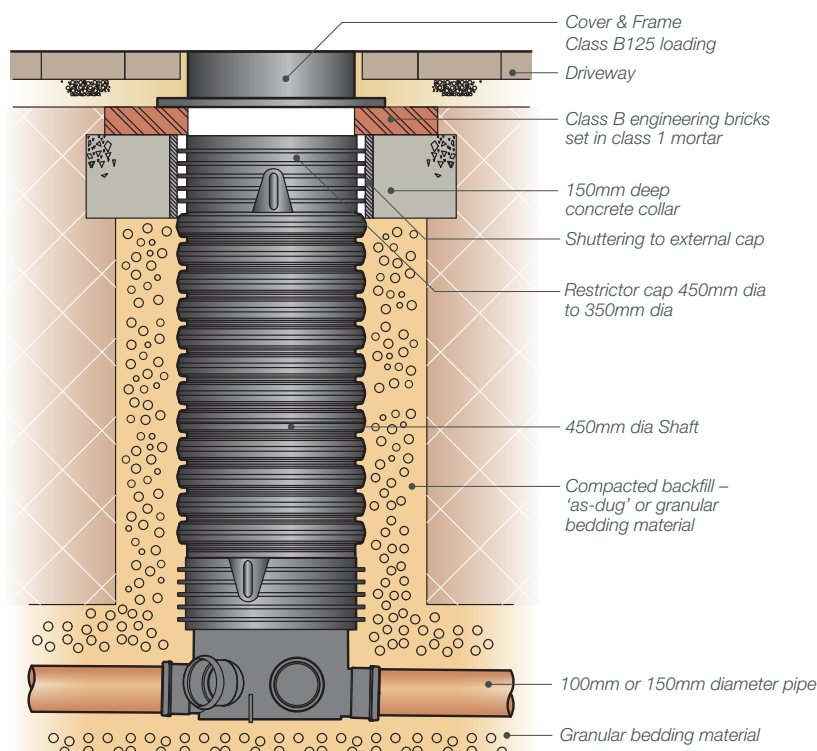

Installation: Chambers

Range 450 Inspection Chamber

Cover and frame installation

For A15 applications in domestic garden areas and/or subject to occasional vehicle loading up to 15kN (1.5 tonnes) – see Fig 32.

- Leave top 150mm of shaft clear of backfill
- Lay 150mm thick slab of pre-cast or in situ concrete around top of shaft chamber
- Prepare A15 cover and frame for installation in accordance with manufacturer's instructions
- Position the cover and frame socket on top of slab and fix in accordance with manufacturer's instructions

For B125 – Paved areas with limited traffic load up to 125kN (12.5 tonnes) – see Fig 33.

- Trim shaft section at last stage of construction. Ensure unit is at correct height
- Protect shaft from traffic loading by shuttering its external ribs
- Lay 150mm thick slab of pre-cast or in situ concrete around top of shaft chamber with minimum opening 750mm x 750mm – or 750mm diameter – to ensure that any loads are distributed away from the shaft
- Position Ductile Iron B125 cover and frame on top of slab

Fig. 32 – Installation detail A15 – domestic gardens and/or areas subject to occasional vehicle loading

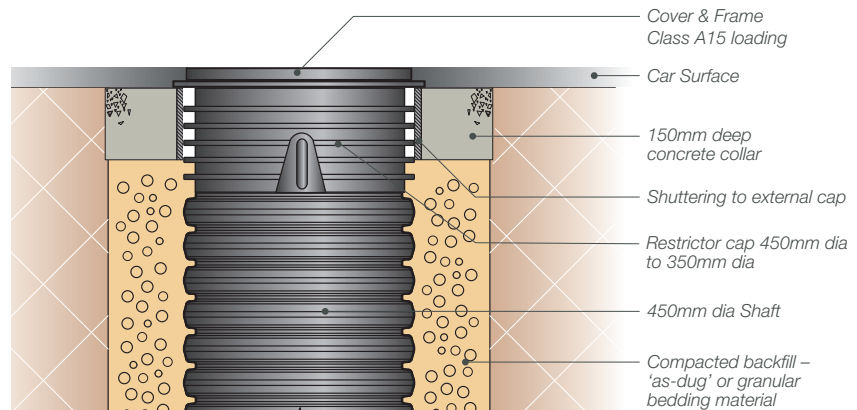
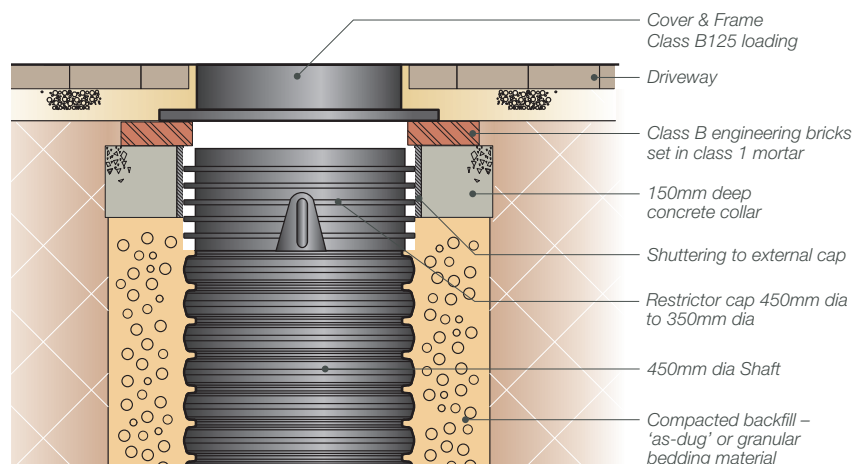

Fig. 33 – Installation detail B125 loading – paved areas with limited traffic load



Installation: Chambers

Range 600 Inspection Chamber

Typical Installation

The following is a summary of installation procedures following selection of a suitable Range 600 base for the required number of inlets.

Excavation

- Take precautions against trench collapse

Preparation

- Prepare and compact 100mm regulating bed of granular material in trench bottom

Positioning/ connection

- Position base on regulating bed. Check outlet is facing downstream
- Ensure all inlets/outlet are free from dirt or grit
- For connection to 150mm, 225mm and 300mm SuperSleeve clay pipes use adaptors TA/2 with 150 base, TA/4 with 225 base and TA/7 with 300 base

NOTE: If finished ground level is not yet known, leave shaft proud of surface and keep covered and secure until final completion.

Backfill

- Using same material as bedding, backfill around base in 150mm layers up to underside of shaft socket. Ensure inside of base is free of debris

Preparing shaft

- Cut corrugated shaft to approx. invert depth of chamber.
RECOMMENDATION: leave extra 300mm depth to allow for possible final site changes
- Locate sealing ring between 2nd and 3rd ribs from shaft bottom. Ensure ring is seated correctly and not twisted
- Clean inside of base socket and lubricate this entire area
- Position shaft and manually push home

Backfill trench

- Before starting backfill, cover top of chamber to prevent ingress of dirt or grit

Trim shaft / fit restriction access cap

- Trim shaft to required height using fine toothed saw

NOTE: If finished ground level is not yet known, leave shaft proud of surface and keep covered and secure until final completion.

- When shaft trimmed to final height, locate sealing ring between 2nd and 3rd ribs from shaft top. Ensure ring is seated correctly and not twisted
- Lubricate inside of the restrictor cap, position over top of shaft, and push home

Fig. 34 – Typical installation domestic detail: Range 600 Inspection Chamber. Type 3

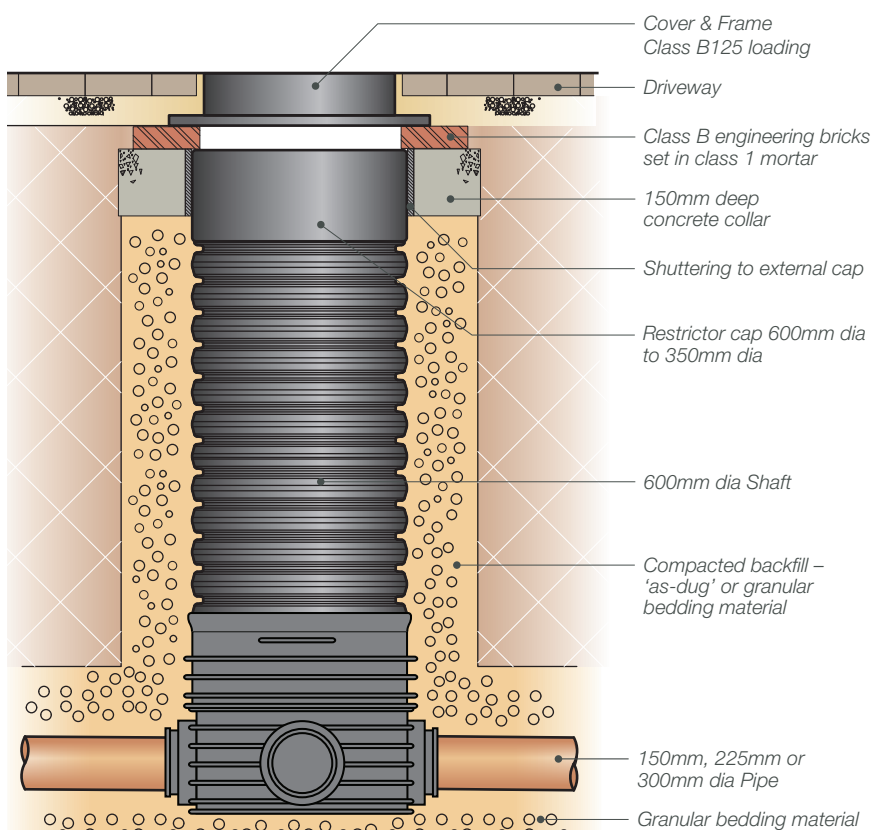

Installation: Chambers

Range 600 Inspection Chamber

Cover and frame installation

For A15 applications in domestic garden areas and/or subject to occasional vehicle loading up to 15kN (1.5 tonnes) – see Fig 35.

- Leave top 150mm of shaft clear of backfill
- Lay 150mm thick slab of pre-cast or in situ concrete around top of shaft chamber
- Prepare A15 cover and frame for installation in accordance with manufacturer's instructions
- Position the cover and frame socket on top of slab and fix in accordance with manufacturer's instructions

For B125 – Paved areas with limited traffic load up to 125kN (12.5 tonnes) – see Fig 36.

- Trim shaft section at last stage of construction. Ensure unit is at correct height
- Protect shaft from traffic loading by shuttering its external ribs
- Lay 150mm thick slab of pre-cast or in situ concrete around top of shaft chamber with minimum opening 750mm x 750mm or 750mm diameter to ensure that any loads are distributed away from the shaft
- Position Ductile Iron B125 cover and frame on top of slab

Fig. 35 – Installation detail A15 – domestic gardens and/or areas subject to occasional vehicle loading

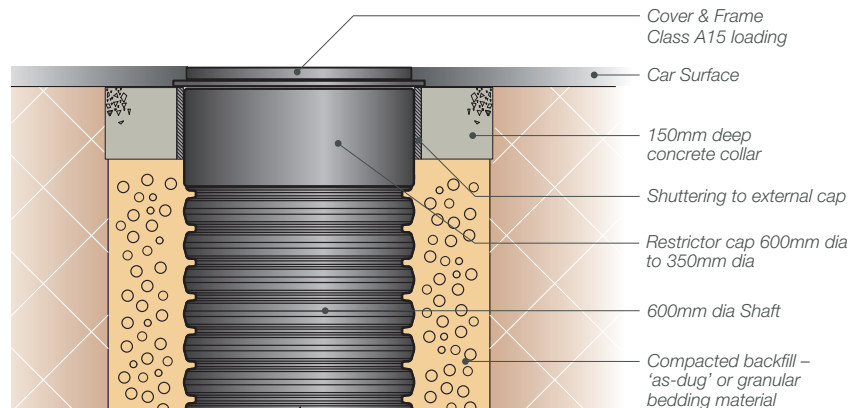
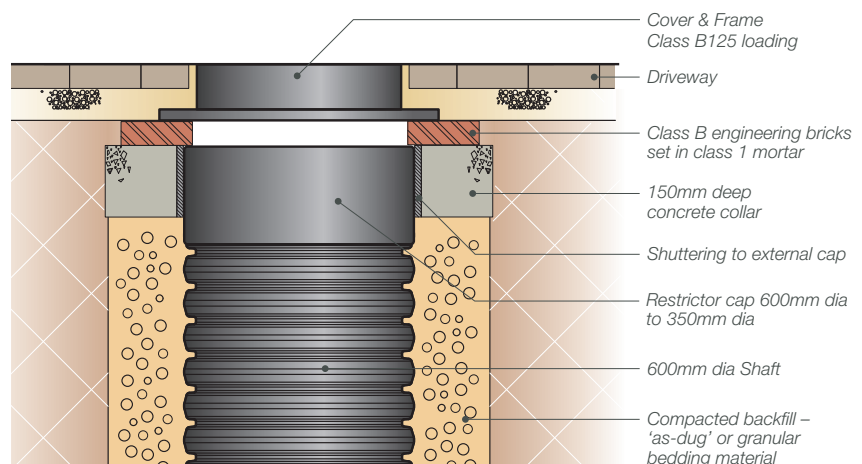

Fig. 36 – Installation detail B125 loading – paved areas with limited traffic load



Installation: Manhole

Conventional manhole construction

Manhole construction, showing use of SuperSleve 100 or 150mm components and 1/2 section and 3/4 section channels. For entry angles up to 45° to the main channel use 1/2 section, over 45° and up to 90° use 3/4 section, and over 90° use a 3/4 section 90° branch bend plus a bend up to 45° externally so that the angle of entry is not greater than 90° at the internal face of the chamber.

The risk of shear fractures is considerably reduced by the provision of a flexible joint located as close as possible to the face of the structure, within 150mm, for smaller diameter pipes. If there is any reason to expect differential settlement the length of the next pipe ('rocker' pipe) away from the structure should not exceed 0.6m length.

Where considerable differential settlement is anticipated several 'rocker' pipes should be laid instead of a single 'rocker' pipe and the gradient should if necessary be increased locally so as to reduce the likelihood of a backfall developing.

Fig. 37 – Manhole construction with flexible joints

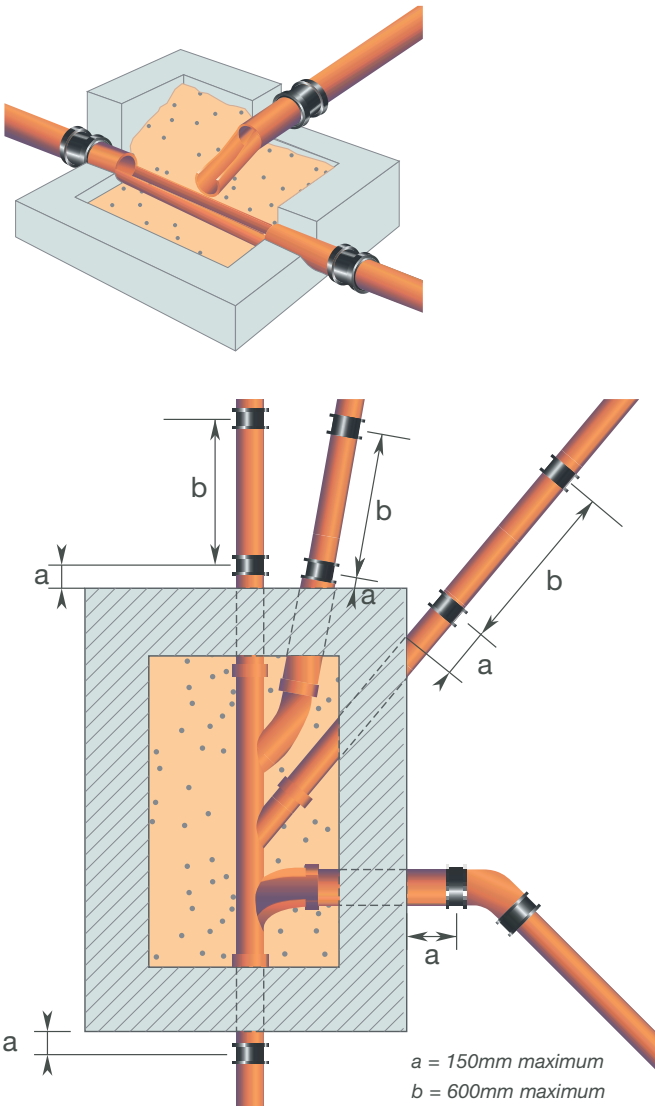
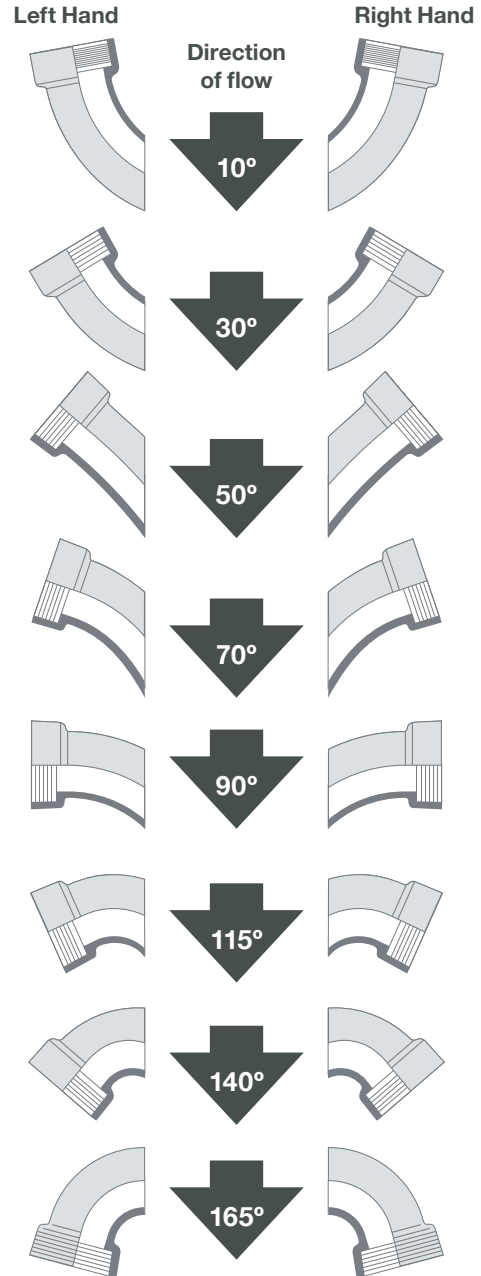

Fig. 38 – Branch channel bend selector (for half section and 3/4 section)



Installation: Connections

Backdrop connections

A backdrop to a manhole is a method of connecting two substantially different drain line invert levels in a manhole. This can be done using the following 100mm or equivalent 150mm SuperSleve fittings, as follows.

For an external backdrop, use a 90° curved square junction (SJ2/1), vertical pipe cut to suit and a rest bend (SBR1). A socket adaptor (SA1/1) cut to suit and a lever locking stopper (IL1) are also required to provide the rodding access to the higher-level drain. See Fig 39.

Fig. 39 – Backdrop connections

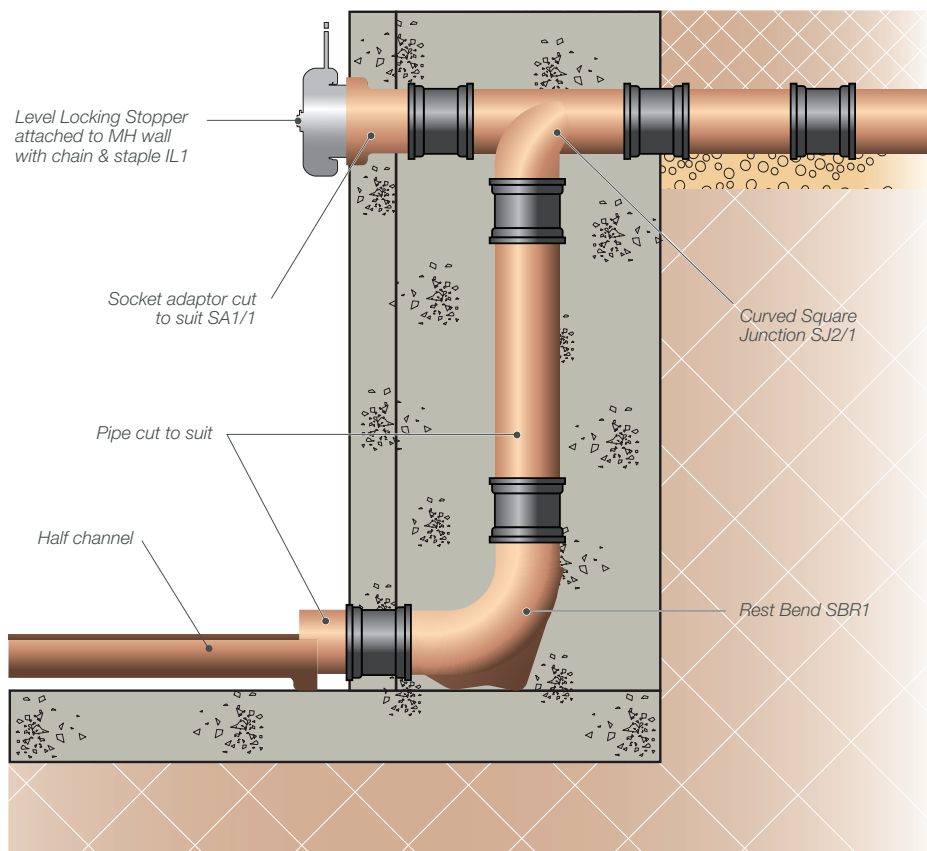

Installation: Connections

Pipe connections

Connecting SuperSleve 100mm Diameter to:

OsmaDrain 110mm

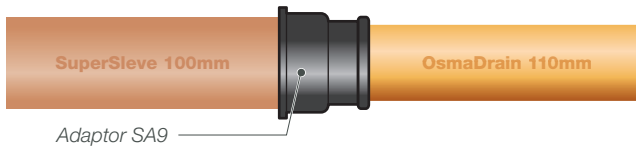

HepSleve 100mm

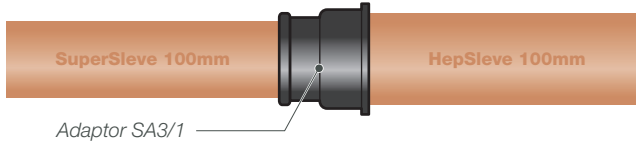

100mm Traditional/Salt Glazed Pipe

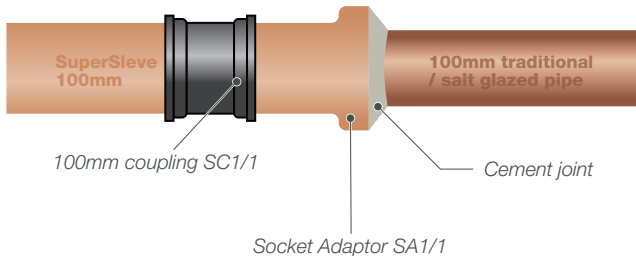

Connecting SuperSleve 150mm Diameter to:

OsmaDrain 160mm

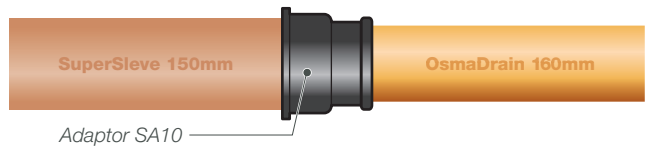

HepSleve 150mm

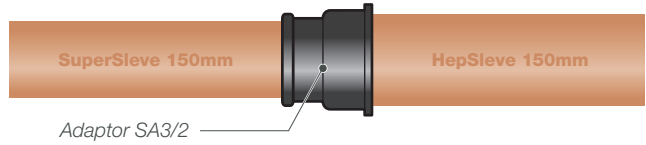

150mm Traditional/Salt Glazed Pipe

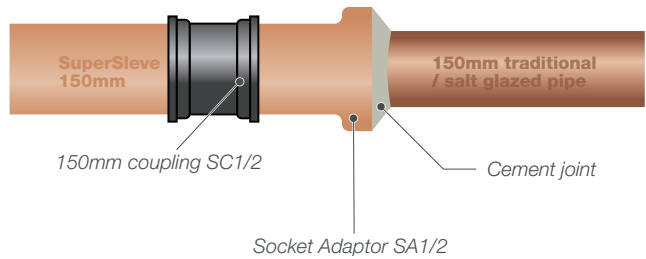

Installation: SuperSleeve

Cutting

The following advice will help you to select the optimum pipe cutting technique according to the pipe diameter you are using. Appropriate selection will make installation quicker and easier on site. Unnecessary pipe cutting can be avoided by the use of standard short length pipes at 0.3, 0.6 and 1.0m. These can be used to adjust the pipeline length at manhole and junction positions. Where cutting is necessary, chain cutters, diamond tipped and carborundum masonry saw blades can be used as advised below.

Health and safety information

To ensure your safety, Hepworth strongly advise the use of appropriate personal protective equipment (PPE). This should include the use of goggles or similar eye protection, ear protection, dust mask, gloves and safety footwear when using pipe cutters or powered masonry saws. Further Health and Safety data is available in the form of a Material Safety Data sheet for Fired Clay Products. Available from www.hepworthclay.co.uk

Short length pipes

Pipe cutting can be minimised and installation time reduced by the use of standard short lengths. They are primarily for use at manhole positions as rocker pipes or to adjust the pipeline length at manhole or junction positions. Short lengths are accurately machine cut with diamond tipped blades to ensure a square end. The ends are chamfered externally to assist jointing and rounded internally for hydraulic efficiency.

Lever action pipe chain cutter

There are two models of lever cutter available; the MPC1 is recommended for the cutting of 100mm diameter pipes only. The MPC2 is recommended for both 100mm and 150mm diameters. When using a lever action cutter the following procedure should be followed:



01 Mark the pipe to be cut



02 Pass the chain under the pipe, aligning the cutting wheels with the desired cut line



03 Hook the chain onto the jaw of the pipe cutter



04 Tighten the chain, by pulling the arms together



05 Push down on the handle to snap cut the pipe



06 Remove any sharp edges with pipe trimmer

- Pass the chain under the pipe, aligning the cutting wheels with the desired cut line on the pipe
- Hook the chain onto the jaw of the pipe cutter
- Tighten the chain, by pulling arms of cutter together
- Make a final check for alignment of the chain around the pipe, then make a snap cut

Powered masonry saw

This method can be used to cut any size of pipe. The blade type can be either carborundum or diamond tipped. The most efficient and best quality cut will be achieved by using a diamond tipped blade which has been specially designed for cutting hard ceramic or marble products. A carborundum blade will produce an acceptable cut, but the speed of cut will be slower and life of blade shorter. When using a powered masonry saw a safe system of work should be followed:

- Before any pipe cutting operation is started, read and adhere to the safety and operating instructions of both the masonry saw and the blade manufacturer
- Check that the masonry saw is fitted with the correct specification of blade
- Make a clear mark around the circumference of the pipe at the desired length
- The pipe being cut should be positioned in a horizontal and stable position
- Care should be taken to support and secure both halves of the pipe being created by the cut, to avoid the blade being nipped as the pipe separates
- With the correct personal protective equipment in place commence the cut; the best quality cut is generally achieved by making one continuous cut, rotating the pipe

Trimming

After cutting with the chain cutter any sharp edges left on the cut pipe will require trimming with the pipe trimmer (product code MPT1) for 100mm or 150mm diameter pipes.

Remove the sharp cut end with the SuperSleeve Pipe Trimmer, set to suit the pipe diameter. When the setting of the trimmer is changed, ensure that the clamping bolts allow running clearance to the cutting cylinders. To use the trimmer, press the cutting cylinders lightly on to the pipe end, and give the tool about a dozen twists back and forth. For larger diameter pipes an emery stone should be used.



View at [youtube.com/WavinUK](https://www.youtube.com/WavinUK). Select the Hepworth Clay playlist.

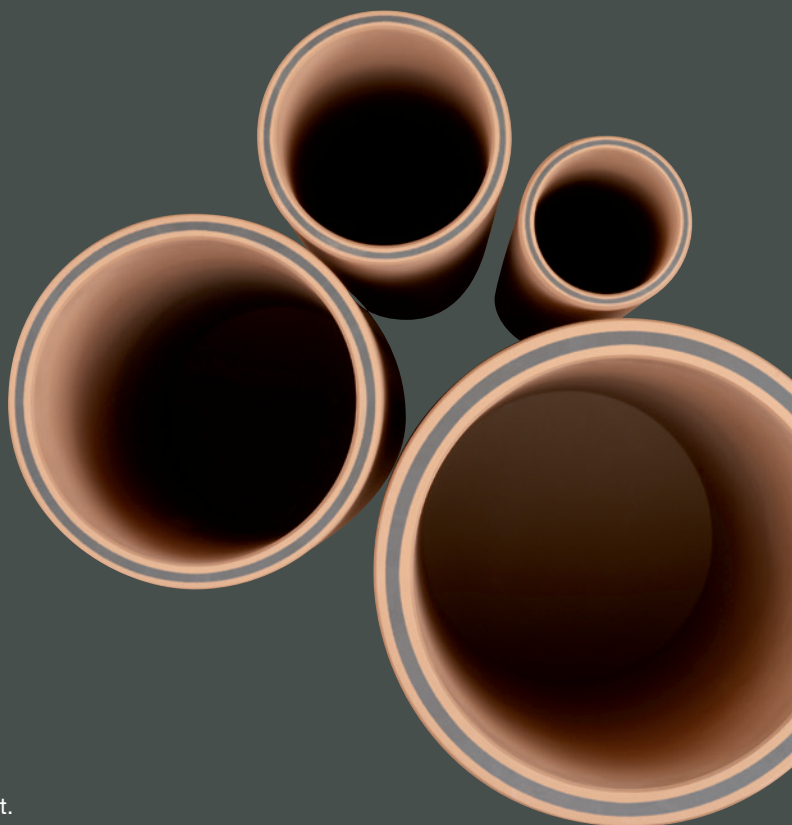

Installation: SuperSleve

Jointing

Store

Keep the pipes, fittings and couplings in their delivery packaging until ready for use. Place them near the works this will keep them clean and accessible.

For guidance on unloading pipes from pipe packs see page 95 or youtube video.

Check

Pipes, fittings and couplings should be checked for signs of obvious damage immediately before use. If found to be damaged, do not use them in the installation.

Clean

Ensure that the jointing area on the outside of the pipe or fitting is clean and free from dirt.

Lubricate

Apply Hepworth Clay lubricant to the pipe end or fitting chamfer and most of the way to the required insertion depth.

Do not lubricate the coupling.

The full insertion depth can be easily identified on 100mm and 150mm pipes by small crow's feet marks near the ends of the pipes. 225mm and 300mm pipes, by half the depth of a coupling. A short pencil line can be made on the top of the pipe for this purpose.

If the pipes or fittings are not lubricated, or an incorrect lubricant is used, then the pipe may not reach the central stop in the coupling. This could create a gap between the pipes being jointed and could be reported in a CCTV survey.

Apply

Push or pull a coupling onto a lubricated pipe or fitting until it meets the central stop in that coupling. Ideally, couplings should be applied to the upstream end.



01 Lubricate the pipe end



02 Press the coupling on to the lubricated pipe end

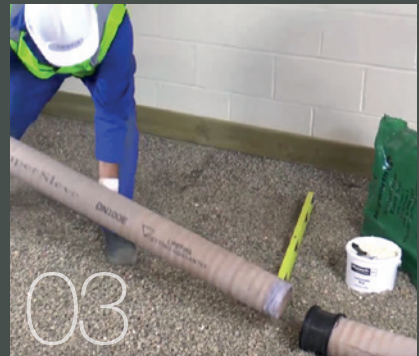

03 Push into previously laid SuperSleve pipe



04 Larger pipe sizes can be jointed with the assistance of a bar



05 Completed joint



06 Check the pipeline is laid to the correct gradient

Lay

Lay the first pipe in the trench, with the coupling fitted and facing upstream. Brace the downstream end temporarily to provide adequate resistance when jointing the next pipe. Apply a coupling to the next pipe or fitting to be laid, as described above.

Align the lubricated pipe end centrally to the coupling of the pipe previously laid, taking care to prevent dirt and bedding material from getting into the joint.

Joint

Smaller pipe sizes are simply pushed home by hand. Larger pipe sizes can be jointed with the assistance of a bar for added leverage, protecting the coupling face with a wooden block.

Ensure that the pipe is fully inserted up to the crow's feet or pencil mark. When jointed correctly, a soft clunk may be felt and heard.

Check

Once the pipe is jointed, check that the pipeline is laid to the correct line and gradient, using a spirit level and string line or laser alignment equipment as specified.

It is recommended that no more than three pipes are laid before applying a quick intermediate air test on the pipeline to confirm correct jointing procedure. If an issue is detected, then it can be easily and quickly rectified. See testing video link.

Nitrile sealing rings

If installing couplings with Nitrile seals, which are identified by a blue sticker on each coupling and on each coupling bag, we recommend that you use our high-performance jointing lubricant, product code SL1C. This lubricant can also ease installation on site during the winter months when the weather is cold and wet.

SuperSleeve Jointing



View at [youtube.com/WavinUK](https://www.youtube.com/WavinUK). Select the Hepworth Clay playlist.



Installation: SuperSleeve

Testing

A test for water tightness using the air or water test should be applied initially after the system has been installed, before any backfilling and again after backfilling is complete.

General

Visually inspect the pipeline for obvious signs of damage and for incorrectly made joints. Carefully check that all stoppers and tubing are airtight. Flush out the whole system with water to remove any silt and debris before final tests are applied.

Air Test

For pipes up to 300mm diameter, the test is carried out by measuring the loss of air pressure in the pipeline over a period of 7 minutes.

Fit expanding stoppers or inflatable test bags in the ends of all the pipelines and branches, making sure that the pipe surface is clean, and the stoppers are firmly in position. Connect a "U tube" gauge (manometer) to a testing stopper

at the upstream end of the pipeline. Apply pressure to achieve a 110mm water gauge on the manometer. Allow approximately 5 minutes for stabilisation, and then adjust the pressure to 100mm water gauge.

If the pressure drop is less than 25mm water gauge on the manometer over a period of 7 minutes, the pipeline passes. In the event of a single or continued air test failure, recourse to a water test is allowed and the result of the water test alone shall be decisive.

Possible reasons for failure

1. Leaking or faulty testing stoppers. Check these again with soapy water to locate leaks
2. Temperature changes of the air in the pipe due to the effects of direct sunlight, or a change in the cloud cover, cold wind or rain, which can give misleading results
3. Product failure, e.g. damaged pipes or incorrectly made joint



01 Carefully check that all stoppers are in good condition



02 Fit expanding stoppers in the end of all pipelines and branches



03 Connect a "U tube" gauge (manometer) to the testing stopper



04 Apply pressure to achieve a 110mm water gauge on the manometer



05 Allow approx. 5 minutes for stabilisation before adjusting the pressure to 100mm water gauge.



06 Measure the pressure drop over a period of 7 minutes

It is recommended that no more than three pipes are laid before applying a quick intermediate air test on the pipeline to confirm correct jointing procedure. If an issue is detected, then it can be easily and quickly rectified.

Water test

For pipes up to 300 mm diameter fill the system with water to a maximum depth of 5 metres above the lowest invert in the test section and a minimum depth of 1 metre above the highest invert in the test section. On steep runs it may be necessary to test in sections, to avoid exceeding the maximum head. This should then be left for one hour to condition the pipeline. The level of water should then be maintained for a period of 30 minutes by topping up to within 100 mm of the required level throughout the test. The quantity of water used should be recorded.

The loss per square metre of internal pipe surface area should not exceed –

0.15 litres for test lengths consisting of pipes only,
0.20 litres for test lengths including pipes and manholes,
0.40 litres for tests on inspection chambers or manholes only.

As a guideline, per 10 metres of pipe run, this equates to –

Pipe diameter (mm)	Permitted loss (litres)
100	0.47
150	0.72
225	1.07
300	1.41

Possible reasons for failure

1. Leaking or faulty testing stoppers. Check these again with soapy water to locate leaks.
2. Dryness of the pipe wall allowing continued absorption, or air trapped in couplings being dissolved. In such cases the line should be left to stand until conditions have stabilised.
3. Product failure, e.g. damaged pipes or incorrectly made joint.

SuperSleeve Testing



View at [youtube.com/WavinUK](https://www.youtube.com/WavinUK). Select the Hepworth Clay playlist.

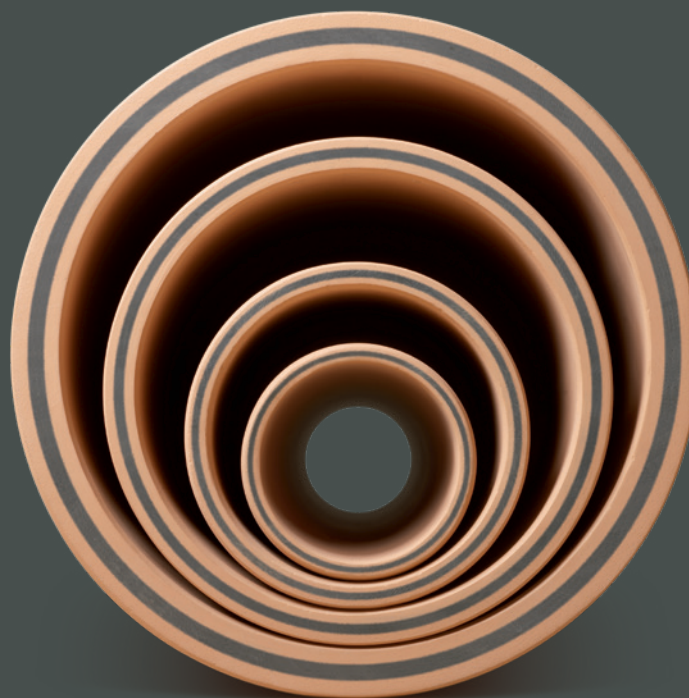

Installation: Health and safety, maintenance

Health and safety

To ensure your safety; Hepworth strongly recommend the use of the correct form of personal protective equipment (PPE) when cutting or handling clay pipes. This should include goggles or similar eye protection, along with sturdy gloves. Further Health and Safety data is available in the form of a Material Safety Data Sheet for Fired Clay Products.

Download from www.hepworthclay.co.uk

The relevant regulations detailed in the Health and Safety at Work Act 1974 must be adhered to on site.

Handling and trench safety

Take care when removing pipes from pipe packs to prevent damage or injury. The metal wires on 100/150mm pipe packs should NOT be cut at any time. See page 95 for the correct dismantling method.

For all sizes take care when cutting the plastic banding on pipe packs as they are under considerable tension and may flail when cut.

Follow the relevant guidance when digging trenches to prevent accidents from trench collapse.

Use the correct fencing and marking as required by the site.

Maintenance

Correctly designed and laid pipelines will need no maintenance with the possible exception of rodding to clear a blockage arising from misuse. Refer to the section on provision of access page 78 for guidance on the location and type of access needed.

An inherent advantage of vitrified clay drainage systems is that any type of drain clearing equipment, including power rodding, can be used, as only gross misuse could result in damage to pipes or fittings.

Clay drainage's resistance to high water pressure jetting means more blockages will be cleared first time with reduced risk. SuperSleve pipe has a Lifetime Jetting Guarantee* of 7,500 psi.

It is desirable that accumulated deposits should be removed periodically from gullies, the frequency of clearing depending on local observations. After clearing, traps should be flushed with clean water.

*When laid in accordance with our instructions and the requirements of the codes of practice and guides relevant to their use.

General information

Supply

Hepworth Clay drainage systems are supplied through a nationwide network of Premier Stockists. For further information contact Customer Services on **0800 038 0088** or visit **stockist.wavin.co.uk** for our stockist locator tool.

Downloads

All Hepworth Clay literature, material safety datasheets, certificates and CAD details can be downloaded from **hepworthclay.co.uk**

Or contact **literature@wavin.co.uk**



'How to' videos

To accompany this brochure, there is a set of 'how to' Hepworth Clay videos to give guidance on a range of installation and maintenance issues.

They can be viewed at **www.youtube.com/WavinUK** under the Hepworth Clay playlist or from **hepworthclay.co.uk**

- How clay drainage can benefit your next project
- How to join clay pipes
- How to cut clay drainage pipes
- Dismantling a Hepworth Clay pipe pack
- How to air test clay pipes
- Troubleshooting clay pipe air test failures



Training

Develop your knowledge and keep up to date with our range of CPD presentations and online e-learning modules.

- CPD: Whole life value within clay drainage systems
- Online: Hepworth Clay introductory level product training module covering SuperSieve and Inspection Chambers

Visit **hepworthclay.co.uk** for e-learning link / booking forms.

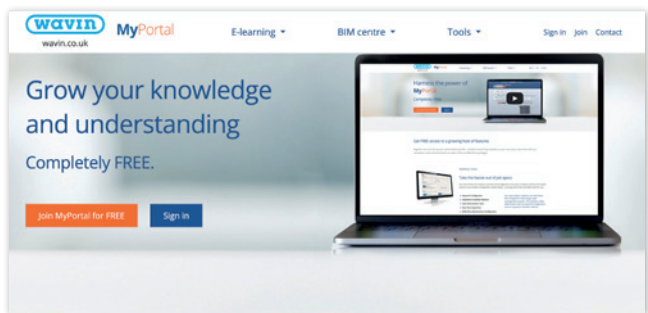

Technical tools

Register on **myportal.wavin.co.uk** for access to great tools to help you get the job done faster and with assured accuracy. Includes Inspection Chamber Selector.

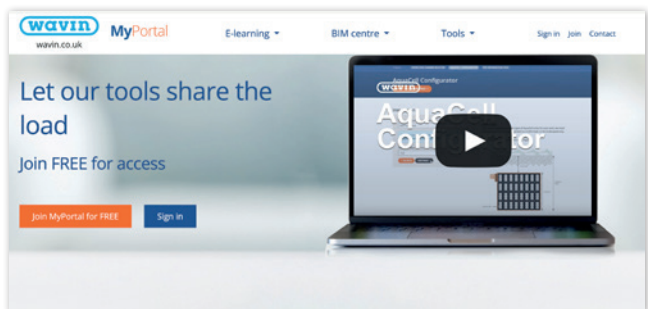

Technical design

For any technical enquiries please contact:

Tel: **0800 038 0088**

Email: **drainage@hepworth.co.uk**

Hepworth

Fired to Perfection

CLAY

Hepworth Clay drainage systems from Wavin are manufactured from natural materials to produce durable, high strength, quality products. This enables sustainable installation on site using recycled aggregates, and rigorous maintenance regimes in service. These market leading clay drainage systems are accepted within the built environment for residential, adoptable, commercial and industrial applications.

Wavin Limited
Edlington Lane
Edlington
Doncaster
South Yorkshire
DN12 1BY

T: 0800 038 0088
E: drainage@hepworth.co.uk
www.hepworthclay.co.uk

