

PRODUCT AND INSTALLATION MANUAL

# Wavin HDPE

Soil, Waste and Vent  
Applications



An Orbia business.

# Wavin HDPE

## Soil, Waste and Vent Applications



## Contents

<b>Introduction</b>	<b>2</b>	3.6 Installation of Wavin fire protection sleeves	36-38
Soil, Waste and Vent System	3-4	3.7 Wavin HDPE Airmix “Sovent” fitting	39
1. HDPE Soil, Waste and Vent System	3	3.8 Casting in heat cured concrete and extrusion shrinkage	40
1.1 System Description	3	3.9 Cast-in pipework	40
1.2 Material Characteristics	3		
1.3 Applications	4	<b>Construction, Testing and Maintenance</b>	<b>41</b>
1.4 Product Specifications	4	4. Situations During Construction	41
		5. Pressure Testing	41
<b>Product Details</b>	<b>5-26</b>	6. Maintenance	41
<b>Assembly</b>	<b>27-31</b>		
2. Assembly	27	<b>Chemical Resistance</b>	<b>42-45</b>
2.1 General	27	7. Chemical Resistance	42-45
2.2 Jointing	27-31	<b>Packaging, Transport and Storage</b>	<b>46</b>
		8.1 Packaging	46
<b>3. Installation</b>	<b>32-40</b>	8.2 Transport	46
3.1 Installation using flexion legs / expansion bends	32	8.3 Pipe Storage	46
3.2 Operation, treatment and installation of expansion sockets	32-33	8.4 Storing Moulded Fittings	46
3.3 Rigid installation of open-mounted HDPE piping	34		
3.4 Securing using fixed points	34	<b>General Information</b>	<b>47-48</b>
3.5 Installation of expansion joints	35-36		

# Wavin HDPE Introduction

## Soil, Waste and Vent Applications

# HDPE Soil, Waste and Vent Applications

This technical manual on HDPE above-ground drainage systems provides a solution to the removal of domestic waste water and rainwater from residential and commercial properties using plastic piping systems.

It covers all aspects from design to installation. The manual is intended for clients, architects, construction specialists, building engineers, building inspectors and of course installers. If you have any questions, or practical problems not covered by this manual then please contact your Technical Sales Manager or email our Technical Centre at [technical.design@wavin.co.uk](mailto:technical.design@wavin.co.uk)

Since our systems are often utilised in circumstances beyond our control, we cannot accept liability for the consequences of applying the information provided in this manual. This edition of the manual supersedes all previously published technical data.



## Soil, Waste and Vent Applications

# Wavin HDPE



### 1. HDPE Soil, Waste and Vent System

#### 1.1 System Description

Wavin HDPE is a universal system approved for pipe installation in buildings to DIN 19535 and DIN EN 1519.

The product range includes pipes and fittings with dimensions between 40mm and 315mm.

Wavin HDPE is a complete soil, waste and vent system of pipes and fittings, manufactured from high-density polyethylene (PE HD). This tough and durable HDPE system offers an extraordinary chemical resistance in combination with a high flexibility level and great impact resistance. Wavin HDPE pipes and fittings are jointed by welding, making the joints resistant to tension. There are two methods of welding: butt welding and electro-fusion welding. Most Wavin HDPE products can also be used as part of negative pressure installations like the siphonic roof drainage system Wavin QuickStream.

#### 1.2 Material Characteristics

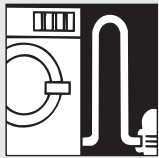

##### High-temperature resistance

Wavin HDPE is resistant to temperatures of up to 90°C continuous temperature and 100°C short term conditions

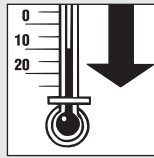

##### Low-temperature resistance

The elasticity of Wavin HDPE allows pipes to withstand freezing of internal water

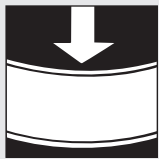

##### Flexibility

Wavin HDPE is well suited to assemblies subjected to vibration. It is therefore ideal for use in seismic zones and across expansion joints



##### Impact resistance

Wavin HDPE's elasticity gives pipes a high impact strength at temperatures as low as -40°C. This ruggedness makes handling of pipes easy during installation

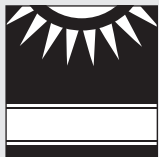

##### UV resistance

With the addition of a percentage of carbon black, HDPE is UV-stabilised and can therefore be installed outdoors without degradation problems

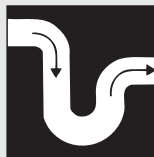

##### Smooth Bore

The smooth surface of Wavin HDPE allows for both an optimum flow of any type of waste material and self-cleaning of pipes



##### Ease of welding

An advantage of Wavin HDPE is that it can be welded (both by butt welding and with electrofusion joints), thereby providing a perfectly sealed system



##### Fire Hazards

Wavin HDPE does not issue any toxic gases during combustion

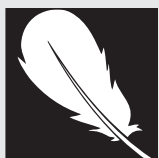

##### Low weight

Wavin HDPE's lightness makes transportation and handling easy



##### Wavin HDPE connection seals

Quick-fit coupling and expansion joint seals remain resistant to waste water from household appliances, laboratories and hospitals. The seals are produced from an elastomer which guarantees sealing and durability even in extreme conditions

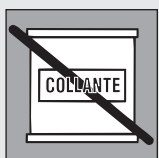

##### Use of adhesives

Because of its high resistance to chemical agents, Wavin HDPE cannot be jointed with adhesives

# Wavin HDPE

## Soil, Waste and Vent Systems

### 1.3 Applications

#### Domestic waste-water system

Tensile resistant joint technology guarantees the highest levels of leakage security. The Wavin HDPE waste-water piping system complies with DIN 19535 and DIN EN 1519 and is resistant to the effects of hot water. It meets the requirements of DIN EN 12056 and DIN 1986 -100 (95° short-term loading).

#### Rainwater piping

Wavin HDPE waste-water piping is suitable for use on rainwater drainage systems. HDPE piping can be used in low-pressure systems to drain free surface waters and rainwater (see the Wavin QuickStream technical handbook).

#### Industrial waste-water

The Wavin PE system is resistant to aggressive chemicals. Further details about the chemical resistance of PE-HD can be found in chapter 7 on pages 42-45.

#### Manufacture and testing

Wavin HDPE piping complies with the technical specifications in DIN EN 1519 and DIN 19535 Part 2 as tested by the National Materials Testing Facility.

### 1.4 Product Specifications

#### Basic material

Wavin HDPE waste-water pipes and fittings are manufactured from PE - HD material.

#### Colour

Black

#### Identification and labelling

Wavin HDPE, nominal diameters, year of manufacture, material, supervision marks, fire category: B2

Example: Wavin HDPE EN 1519 IIP 152 UNI Ue DIN 19535 DN 100 110 x 4.3 PE BD S 12.5 weldable, tempered A-M-G-T

#### Properties

Melt flow index: 0.3 – 0.89 g/10 min  
 Coefficient of expansion: 0.2 mm/m °C  
 UV resistance: given by carbon content of 2 – 2.5 %  
 Fire behaviour: DIN 4102, B2

#### Pipe data

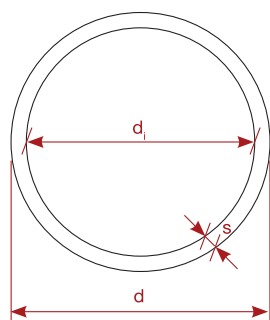

Calculation of SDR classes

$$SDR = \frac{d}{s}$$

Table 1: Pipe data

DN	d <sup>1)</sup>	d <sup>2)</sup>	s <sup>3)</sup>	SDR <sup>4)</sup>	SN
40	40	34.0	3.0	13.6	–
50	50	44.0	3.0	17	–
56	56	50.0	3.0	17	–
60	63	57.0	3.0	21	–
70	75	69.0	3.0	26	–
90	90	83.0	3.5	26	4
100	110	101.4	4.3	26	4
125	125	115.2	4.9	26	4
150	160	147.6	6.2	26	4
200	200	187.6	6.2	33	2
200	200	184.6	7.7	26	4
250	250	234.4	7.8	33	2
250	250	230.8	9.6	26	4
300	315	295.4	9.8	33	2
300	315	290.8	12.1	26	4

1. Outer diameter in mm
2. Inner diameter in mm
3. Wall thickness in mm
4. SDR class

#### Quality assurance

All piping and fittings are subject to continuous internal quality control procedures. The system is also subject to external monitoring by the Materials Testing Facility. The system conforms to the established technical specifications set out in Building Regulations A, Part 1 Issue 2003/1 No.12.1.8 and comply with DIN EN 1519 - 1:2001-01 and DIN 19535 - 10:200-01.

#### Information on the transportation and storage of HDPE pipes and fittings

HDPE pipes must be protected against damage during transportation and especially during loading and unloading. Prior to any unloading, pipes should be carefully inspected for damage incurred during transportation. Where lifting gear is to be employed, the use of wide belts and slings is recommended. Unpaletted pipes should, wherever possible, be supported along their entire length and prevented from rolling against each other. Pipe storage areas and supporting surfaces should be free from sharp edges.

**Caution:** Short-term pipe deformation can occur where pipes are unevenly exposed to the effects of the sun (or other forms of heat). Pipes should therefore not be stored in direct sunlight.

# Wavin HDPE

## Product details **Soil, Waste and Vent**

### Pipe

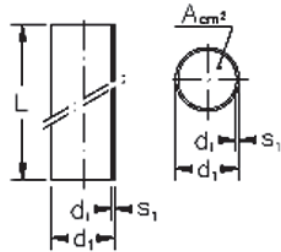

### Pipe

- Pipes: From Ø 75 to Ø 315 pipe series S12,5 / PN 5 and in stiffness class SN 4, suitable for buried application 200 x 7.7, 250 x 9.6, 315 x 12.1
- 200, 250 and 315 mm in class S16 (SN2) available on request
- Nominal diameters according to DIN 19535
- Wavin PE standard pipes are supplied in 5 metre lengths marked with co-extruded green markings or text

Material: HDPE

Nominal Size (mm)	Part Number	Dimensions (mm)				L	A cm <sup>2</sup>
		d1	di	S1			
40	3003465	40	34.0	3.0	5000	9.0	
50	3003466	50	44.0	3.0	5000	15.2	
56	3003477	56	50.0	3.0	5000	23.1	
63	3003467	63	57.0	3.0	5000	25.4	
75	3003468	75	69.0	3.0	5000	37.3	
90	3003458	90	83.0	3.5	5000	54.1	
110	3075609	110	101.4	4.3	3000	80.7	
110	3003459	110	101.4	4.3	5000	80.7	
125	3003460	125	115.2	4.9	5000	104.2	
160	3003461	160	147.6	6.2	5000	171.1	
200	3003462	200	184.6	7.7	5000	267.1	
250	3003463	250	230.8	9.6	5000	418.4	
315	3003464	315	290.8	12.1	5000	664.2	

# Wavin HDPE

## Product details **Soil, Waste and Vent**

### Fittings

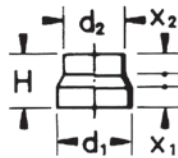

#### Concentric Reducer

- Segment Welded \*

Material: HDPE

Nominal Size (mm)	Part Number	Dimensions (mm)			H
		d1/d2	X1	X2	
50/40	3084576	50/40	30	30	80
56/50	3003820	56/50	30	30	80
63/40	3003796 <sup>▲</sup>	63/40	30	30	80
63/50	3003797 <sup>▲</sup>	63/50	30	30	80
63/56	3003798	63/56	30	30	80
75/50	3003800 <sup>▲</sup>	75/50	30	30	80
75/63	3003801 <sup>▲</sup>	75/63	30	30	80
90/50	3003803 <sup>▲</sup>	90/50	30	30	80
90/63	3003804 <sup>▲</sup>	90/63	30	30	80
90/75	3003805 <sup>▲</sup>	90/75	30	30	80
110/50	3003807 <sup>▲</sup>	110/50	30	30	80
110/56	3003858	110/56	30	30	80
110/63	3003808	110/63	30	30	80
110/75	3003809	110/75	30	30	80
110/90	3003810	110/90	30	30	80
125/63	3003812 <sup>▲</sup>	125/63	30	30	80
125/110	3003815	125/110	30	30	80
160/110	3003816	160/110	32	29	100
160/125	3003817 <sup>▲</sup>	160/125	35	35	100
200/160	3018808*	200/160	100	100	250
250/200	3018809*	250/200	120	120	270
315/250	3018810*	315/250	130	130	325

NOTE: <sup>▲</sup> = Made to order

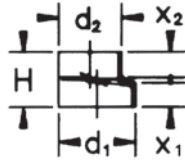

### Eccentric Reducer – Short

Material: HDPE

Nominal Size (mm)	Part Number	Dimensions (mm)			
		d1/d2	X1	X2	H
50/40	3003821	50/40	35	37	80
56/50	3003841	56/50	35	37	80
63/40	3003822Q <sup>▲</sup>	63/40	35	37	80
63/50	3003823Q	63/50	35	37	80
63/56	3003842Q	63/56	35	37	80
75/40	3003824	75/40	33	30	80
75/50	3003825	75/50	35	37	80
75/56	3003843	75/56	35	37	80
75/63	3003826	75/63	35	37	80
90/50	3003827Q <sup>▲</sup>	90/50	31	34	80
90/63	3003828	90/63	31	38	80
90/75	3003829	90/75	31	43	80
110/40	3003830	110/40	31	34	80
110/50	3003831	110/50	31	34	80
110/56	3003835	110/56	31	35	80
110/63	3003832	110/63	35	37	80
110/75	3003833	110/75	31	36	80
110/90	3003834	110/90	35	37	80
125/75	3003836Q <sup>▲</sup>	125/75	35	30	80
125/90	3003837Q	125/90	35	32	80
125/110	3003838Q	125/110	36	36	80
160/110	3003839	160/110	35	37	80
160/125	3003840	160/125	35	37	80

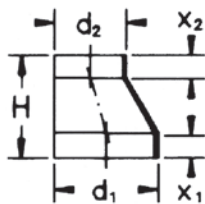

### Eccentric Reducer – Long

- Segment Welded \*

Material: HDPE

Nominal Size (mm)	Part Number	Dimensions (mm)			
		d1/d2	X1	X2	H
200/110	3018811	200/110	110	60	325
200/125	3018812	200/125	110	70	310
200/160	3018813	200/160	110	90	270
250/200	3070632*	250/200	130	110	325
315/200	3014918*	315/200	150	130	325
315/250	3003856*	315/250	150	130	395

NOTE: <sup>▲</sup> = Made to order



# Wavin HDPE

## Product details **Soil, Waste and Vent**

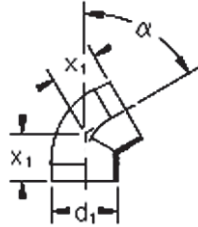

### Elbow 15°

Material: HDPE

Nominal Size (mm)	Part Number	Dimensions (mm)		
		d1	∅	X1
110	3017993	110	15°	45
160	3043453 <sup>▲</sup>	160	15°	130
200	3043454 <sup>▲</sup>	200	15°	133
250	3043455 <sup>▲</sup>	–	–	–
315	3043457 <sup>▲</sup>	–	–	–

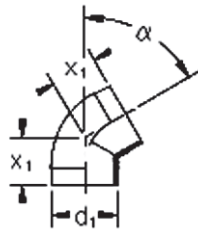

### Elbow 30°

Material: HDPE

Nominal Size (mm)	Part Number	Dimensions (mm)		
		d1	∅	X1
110	3003576	110	30°	55
160	3003584	160	30°	80



### Elbow 45°

- Segment Welded \*

Material: HDPE

Nominal Size (mm)	Part Number	Dimensions (mm)	
		d1	X1
40	3084563	40	40
50	3084565	50	45
56	3003597	56	45
63	3003569	63	50
75	3003572	75	50
90	3003574	90	55
110	3003577	110	60
125	3003582	125	65
160	3003585	160	100
200	3018820	200	160
250	3018821*	250	165
315	3018822* <sup>▲</sup>	315	230

NOTE: <sup>▲</sup> = Made to order

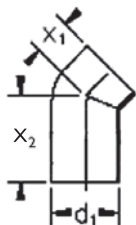

### Elbow 45° Long Tail

Material: HDPE

Nominal Size (mm)	Part Number	Dimensions (mm)		
		d1	X1	X2
110	3075824 <sup>▲</sup>	110	95	156

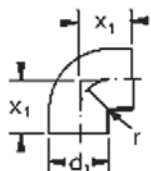

### Elbow 88.5°

- Swept type †

Material: HDPE

Nominal Size (mm)	Part Number	Dimensions (mm)	
		d1	X1
40	3084564 <sup>†</sup>	40	60
50	3084566 <sup>†</sup>	50	70
56	3003598	56	40
63	3003570 <sup>†</sup>	63	80
75	3003573 <sup>†</sup>	75	75
90	3003575	90	80
110	3003579 <sup>†</sup>	110	110
125	3003583 <sup>†</sup>	125	125
160	3003587 <sup>†</sup>	160	180

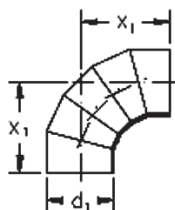

### Elbow 90° Segment Welded

Material: HDPE

Nominal Size (mm)	Part Number	Dimensions (mm)		
		d1	X1	
160	3003943	160	140	(Welded)
200	3018818 <sup>*</sup>	200	250	
250	3017978 <sup>*</sup>	250	335	
315	3018819 <sup>*▲</sup>	315	370	

NOTE: <sup>▲</sup> = Made to order

# Wavin HDPE

## Product details **Soil, Waste and Vent**

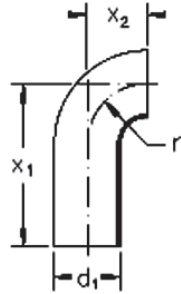

### Elbow 90° Extended

Material: HDPE

Nominal Size (mm)	Part Number	Dimensions (mm)			
		d1	X1	X2	r
40	3084577	40	150	30	30
50	3084567	50	180	40	40
56	3003944	56	210	40	40
63	3003601 <sup>▲</sup>	63	210	50	50
75	3003622	75	210	70	70
90	3003602	90	240	90	90
110	3003603	110	270	103	100
125	3003605 <sup>▲</sup>	125	200	110	110

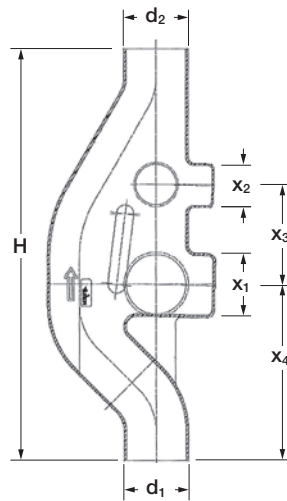

### HDPE Airmix "sovent"

Material: HDPE

Nominal Size (mm)	Part Number	Dimensions (mm)					
		d1/d2	X1	X2	X3	X4	H
110	3003791 <sup>▲</sup>	110	110	75	170	300	700
160	4042219 <sup>▲</sup>	160	110	75	162.6	457.7	950

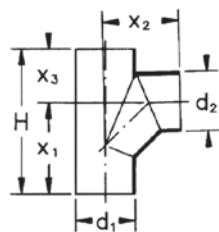

### Swept Branch 88.5°

Material: HDPE

Nominal Size (mm)	Part Number	Dimensions (mm)				
		d1/d2	X1	X2	X3	H
110	3003792	110	170	140	100	270

NOTE: <sup>▲</sup> = Made to order

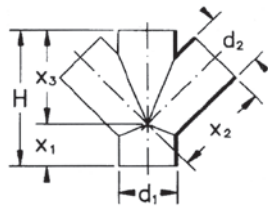

### Double Branch 45°

Material: HDPE

Nominal Size (mm)	Part Number	Dimensions (mm)			
		d1/d2	X1	X2-X3	H
90/50	3018005 <sup>▲</sup>	90/50	80	160	240
110/50	3003730 <sup>▲</sup>	110/50	80	180	260
110/110	3003728	110/110	80	180	260

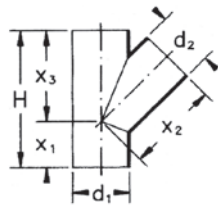

### Branch 45°

- Segment Welded \*

Material: HDPE

Nominal Size (mm)	Part Number	Dimensions (mm)			
		d1/d2	X1	X2-X3	H
40/40	3084570	40/40	45	90	135
50/40	3084574	50/40	55	110	165
50/50	3084572	50/50	55	110	165
56/50	3003725Q	56/50	55	110	165
56/56	3003724	56/56	60	120	180
63/40	3003635Q <sup>▲</sup>	63/40	65	130	195
63/50	3003637Q	63/50	65	130	195
63/56	3003639Q	63/56	65	130	195
63/63	3003633	63/63	65	130	195
75/40	3003643Q	75/40	70	140	210
75/50	3003645Q	75/50	70	140	210
75/56	3003649	75/56	70	140	210
75/63	3003647Q	75/63	70	140	210
75/75	3003641	75/75	70	140	210
90/40	3003654Q	90/40	80	160	240
90/50	3003656Q	90/50	80	160	240
90/63	3003658Q <sup>▲</sup>	90/63	80	160	240
90/75	3003660Q <sup>▲</sup>	90/75	80	160	240
90/90	3003651Q <sup>▲</sup>	90/90	80	160	240
110/40	3003664 <sup>▲</sup>	110/40	90	180	270
110/50	3003666	110/50	90	180	270
110/56	3003674	110/56	90	180	270
110/63	3003668	110/63	90	180	270
110/75	3003670	110/75	90	180	270
110/90	3003672Q <sup>▲</sup>	110/90	90	180	270
110/110	3003662	110/110	90	180	270
125/50	3003678Q	125/50	100	200	300
125/63	3003679 <sup>▲</sup>	125/63	100	200	300
125/75	3003681Q <sup>▲</sup>	125/75	100	200	300
125/90	3003683Q <sup>▲</sup>	125/90	100	200	300
125/110	3003685	125/110	100	200	300
125/125	3003676 <sup>▲</sup>	125/125	100	200	300

Other sizes continued on next page

NOTE: <sup>▲</sup> = Made to order

# Wavin HDPE

## Product details **Soil, Waste and Vent**

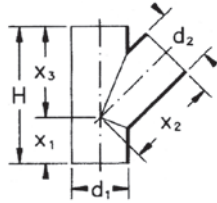

### Branch 45° – Continued

- Segment Welded \*

Material: HDPE

Nominal Size (mm)	Part Number	Dimensions (mm)			
		d1/d2	X1	X2-X3	H
160/110	3003688	160/110	125	250	375
160/125	3003690 <sup>▲</sup>	160/125	125	250	375
160/160	4009725	160/160	125	250	375
200/110	3070633*	200/110	180	360	540
200/125	3018824Q <sup>▲</sup>	200/125	180	360	540
200/160	3070634*	200/160	180	360	540
200/200	3070630*	200/200	180	360	540
250/110	3003705*	250/110	220	440	660
250/125	3003707Q <sup>▲</sup>	250/125	220	440	660
250/160	3003709*	250/160	220	440	660
250/200	3003710*	250/200	220	440	660
250/250	3018826*	250/250	220	440	660
315/110	3003723*	315/110	280	560	840
315/125	3018827 <sup>▲</sup>	315/125	280	560	840
315/160	3018828*	315/160	280	560	840
315/200	3003718*	315/200	280	560	840
315/250	3003719*	315/250	280	560	840
315/315	3018829*	315/315	280	560	840

NOTE: <sup>▲</sup> = Made to order

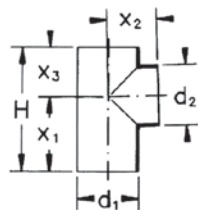

### Branch 88.5°

- Segment Welded \*

Material: HDPE

Nominal Size (mm)	Part Number	Dimensions (mm)			
		d1/d2	X1	X2-X3	H
40/40	3084571	40/40	75	55	130
50/40	3084575	50/40	90	60	150
50/50	3084573	50/50	90	60	150
56/50	3003726	56/50	105	70	175
56/56	3003727	56/56	105	70	175
63/50	3003638	63/50	105	70	175
63/63	3003634 <sup>▲</sup>	63/63	105	70	175
75/50	3003646 <sup>▲</sup>	75/50	105	70	175
75/56	3003650	75/56	105	70	175
75/63	3003648 <sup>▲</sup>	75/63	105	70	175
75/75	3003642	75/75	105	70	175
90/40	3003655	90/40	120	80	200
90/50	3003657	90/50	120	80	200
90/63	3003659 <sup>▲</sup>	90/63	120	80	200
90/75	3003661 <sup>▲</sup>	90/75	120	80	200
90/90	3003652	90/90	120	80	200
110/40	3003665	110/40	135	90	225
110/50	3003667	110/50	135	90	225
110/56	3003675	110/56	135	90	225
110/63	3003669 <sup>▲</sup>	110/63	135	90	225
110/75	3003671	110/75	135	90	225
110/90	3003673 <sup>▲</sup>	110/90	135	90	225
110/110	3003663	110/110	135	90	225
125/63	3003680 <sup>▲</sup>	125/63	150	100	250
125/110	3003686 <sup>▲</sup>	125/110	150	100	250
125/125	3003677	125/125	150	100	250
160/110	3003689	160/110	210	140	350
160/125	3003691 <sup>▲</sup>	160/125	210	140	350
160/160	3003687	160/160	210	140	350
200/110	3003698*	200/110	180	180	360
200/125	3018832 <sup>▲</sup>	200/125	180	180	360
200/160	3003702*	200/160	180	180	360
200/200	3018831*	200/200	180	180	360
250/110	3018002*	250/110	220	220	440
250/125	3018832 <sup>▲</sup>	250/125	220	220	440
250/160	3018003*	250/160	220	220	440
250/200	3018833*	250/200	220	220	440
250/250	3003704*	250/250	220	220	440
315/110	3018834 <sup>▲</sup>	315/110	280	280	560
315/125	3003716 <sup>▲</sup>	315/125	280	280	560
315/160	3018835 <sup>▲</sup>	315/160	280	280	560
315/200	3018836 <sup>▲</sup>	315/200	280	280	560
315/250	3018837 <sup>▲</sup>	315/250	280	280	560
315/315	3003713 <sup>▲</sup>	315/315	280	280	560

NOTE: <sup>▲</sup> = Made to order

# Wavin HDPE

## Product details **Soil, Waste and Vent**

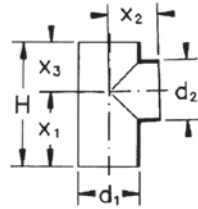

### Boss Pipe – Four Way Extended Spigot

Material: HDPE

Nominal Size (mm)	Part Number	Dimensions (mm)			
		d1/d2	X1	X2-X3	H
110/56	3075823	110/56	136	115-86	222

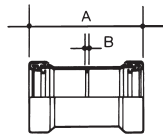

### Universal Connector

- Two push-fit ring-seal sockets
- Connects to 40mm [1½"] or 50mm [2"] pipe to BS EN 1451-1/ BS EN 1455-1 and BS EN 1566-1

Material: Polypropylene

Nominal Size (mm)	Part Number	Dimensions (mm)	
		A	B
40	5W102G ♡	95	3
50	2W102G ♡	105	3

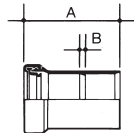

### Expansion Socket – with Solvent Socket Tail

- For creating an expansion joint where provision for thermal movement is required.
- Solvent weld socket and push-fit ring-seal socket Push-fit socket connects to 50mm [2"] pipe to BS EN 1451-1/ BS EN 1455-1 and BS EN 1566-1

Material: ABS

Nominal Size (mm)	Part Number	Dimensions (mm)	
		A	B
50	2Z124W ♡	93	3

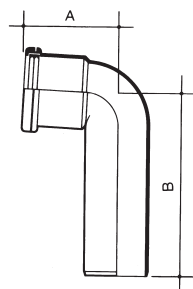

### Long-Tail Bend – 87.5°

- One plain end and one push-fit ring-seal socket
- Push-fit socket connects to 50mm [2"] pipe to BS EN 1451-1/BS EN 1455-1 and BS EN 1566-1

Material: ABS

Nominal Size (mm)	Part Number	Dimensions (mm)	
		A	B
50	2Z359G	80	152



### Rubber Boss Adaptor

- Boss adaptor to 32mm (36mm OD) UK pipe
- Boss adaptor to 40mm (43mm OD) UK pipe

Material: Synthetic Rubber

Nominal Size (mm)	Part Number
56/32	4063088 <sup>▲</sup>
56/40	4063089 <sup>▲</sup>



### Galvanised HDPE Bracket M10 Connection

Material: Galvanised Steel

Nominal Size (mm)	Part Number
40	4012113
50	4012117
56	4063090 <sup>▲</sup>
63	4012121 <sup>▲</sup>
75	4012125
90	4012131
110	4012137
125	4012141
160	4012146



### Bracket Insert

Material: Galvanised Steel

Nominal Size (mm)	Part Number
40	4012329
50	4012331
56	4063093 <sup>▲</sup>
63	4012333 <sup>▲</sup>
75	4012335
90	4012337
110	4012339
125	4012341 <sup>▲</sup>
160	4012343
200	4012345
250	4023375
315	4023376

NOTE: <sup>▲</sup> = Made to order





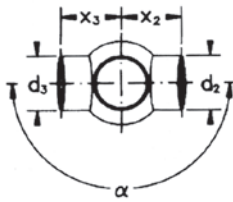
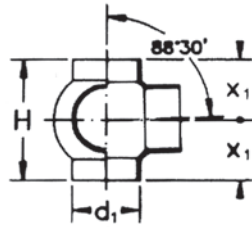

### Spherical Branch, 2 Stubs

Material: HDPE

#### Type A – 180°

Nominal Size (mm)	Part Number	Dimensions (mm)			
		d1/d2-d3	X1	X2-X3	H
110/110	3003755	110/110	100	120	200

#### Type B – 90°

Nominal Size (mm)	Part Number	Dimensions (mm)			
		d1/d2-d3	X1	X2-X3	H
110/110	3003756	110/110	100	120	200

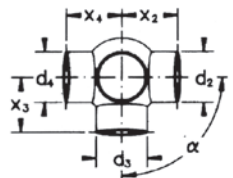
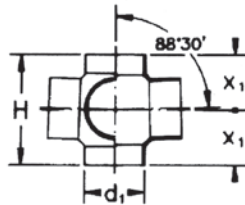
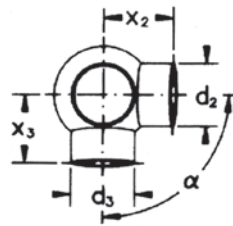

### Spherical Branch, 3 Stubs

Material: HDPE

#### Type E – 90°

Nominal Size (mm)	Part Number	Dimensions (mm)			
		d1/d2-d3	X1	X2-X3	H
110/110	3003776 <sup>▲</sup>	110/110	100	120	200

NOTE: <sup>▲</sup> = Made to order

# Wavin HDPE

## Product details **Soil, Waste and Vent**

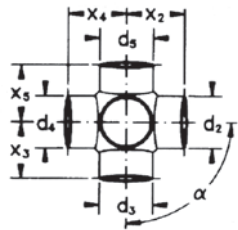

### Spherical Branch, 4 Stubs

Material: HDPE

Type F – 90°

Nominal Size (mm)	Part Number	Dimensions (mm)			
		d1/d2-d3	X1	X2-X3	H
110/110	3003777	110/110	100	120	200

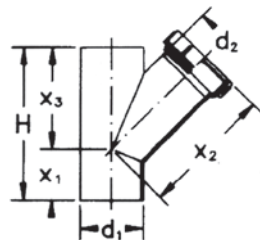

### Access Tee 45°

Material: HDPE

Nominal Size (mm)	Part Number	Dimensions (mm)				
		d1/d2	X1	X2	X3	H
110/110	3003739	110/110	90	230	180	270
125	3003741 <sup>▲</sup>	125	100	200	250	300
160/110	3003743	160/110	125	300	250	375

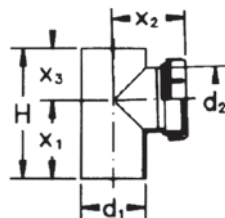

### Access Tee 88.5°

• Segment Welded \*

Material: HDPE

Nominal Size (mm)	Part Number	Dimensions (mm)				
		d1/d2	X1	X2	X3	H
50	3003732 <sup>▲</sup>	50	90	60	85	150
63	3003734 <sup>▲</sup>	63	105	70	80	175
75/75	3003736	75/75	105	90	70	175
90	3003738Q <sup>▲</sup>	90	120	80	100	200
110/110	3003740	110/110	135	125	90	225
125	3018815Q <sup>▲</sup>	125	150	100	130	250
160/110	3070631*	160/110	210	150	140	350
200/110	3017974*	200/110	180	170	180	360
250/110	3017975*	250/110	220	190	220	440
315/110	3017976*	315/110	280	210	280	560

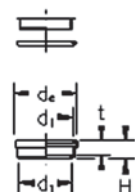

### Wall Mounted Toilet Connector

Material: HDPE

Nominal Size (mm)	Part Number	Dimensions (mm)			
		d1/di	de	t	H
90/90	3003550 <sup>▲</sup>	90/90	110	28	38
110/110	3003554 <sup>▲</sup>	110/110	131	28	38

NOTE: <sup>▲</sup> = Made to order

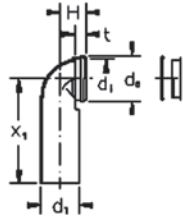

### Wall Mounted Toilet Connector Elbow 90° for hanging toilets

Material: HDPE

Nominal Size (mm)	Part Number	Dimensions (mm)				
		d1/di	de	X1	t	H
90/90	3003619 <sup>▲</sup>	90/90	110	225	34	75
110/90	3018007 <sup>▲</sup>	110/90	110	225	34	75
110/110	3003620 <sup>▲</sup>	110/110	131	300	33	75

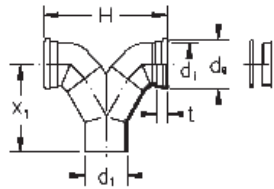

### Wall Mounted Double Toilet Connector Elbow 90°

Material: HDPE

Nominal Size (mm)	Part Number	Dimensions (mm)				
		d1/di	de	X1	t	H
110/110	3003621 <sup>▲</sup>	110/110	131	195	28	270

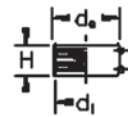

### Electro-fusion Coupler – Universal Type (WAVIDUO)

- To be welded with: Electro-fusion welding machine DUO 315 (Part No. 4036330)

Material: HDPE

Nominal Size (mm)	Part Number	Dimensions (mm)		
		d1	de	H
40	3003478	40	54	52
50	3003479	50	64	52
56	3003489	56	68	52
63	3003480	63	77	52
75	3003481	75	90	52
90	3003482	90	104	54
110	3003483	110	124	64
125	3003484	125	143	64
160	3003485	160	180	63
200	4061068	200	221	148
250	4064881	250	304	244
315	4064882	315	382	268

NOTE: <sup>▲</sup> = Made to order

# Wavin HDPE

## Product details **Soil, Waste and Vent**

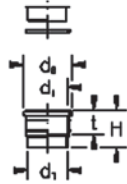

### Push-fit Socket with Gasket and Cap

- To connect HDPE to PVC

Material: HDPE

Nominal Size (mm)	Part Number	Dimensions (mm)			
		d1/di	de	t	H
40/40	3084561	40	57	50	85
50/50	3084562	50	67	50	85
56/56	3003493	56	57	52	85
63/63	3003494 <sup>▲</sup>	63	79	52	85
75/75	3003495	75	92	65	100
90/90	3003496 <sup>▲</sup>	90	110	69	105
110/110	3003497	110	131	70	105
125/125	3003498 <sup>▲</sup>	125	150	75	115
160/160	3003499	160	190	93	140

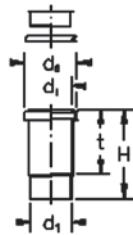

### Expansion Socket with Gasket and Cap

- Segment Welded \*
- To connect HDPE to PVC

Material: HDPE

Nominal Size (mm)	Part Number	Dimensions (mm)			
		d1/di	de	t	H
40/40	3003505	40/40	57	170	235
50/50	3003506	50/50	67	170	235
56/56	3018008	56/56	57	170	235
63/63	3003507	63/63	80	175	235
75/75	3003508	75/75	92	179	240
90/90	3003509	90/90	110	175	240
110/110	3003510	110/110	130	178	255
125/125	3003511 <sup>▲</sup>	125/125	148	180	255
160/160	3003512	160/160	188	190	285
200/200	3003513*	200/200	225	200	345
250/250	3070629	250/250	280	250	405
315/315	3003515	315/315	350	250	405

#### Push-fit depth in mm

Ø	-10°	0°	+10°	+20°
40 – 160	70	80	90	105
200 – 315	170	180	190	205

The expansion sockets from 40 to 315mm absorb the expansion and the contraction of a 5000mm long pipe. 10°C temperature difference = 2mm expansion or contraction per meter. On the expansion socket the push-in depth of the pipe at a room temperature of 0°C and +20°C is mentioned.

The expansion socket Ø 110 has an external ring for fixed-point bracket.

NOTE: <sup>▲</sup> = Made to order



### Complete Screw Connection

Material: HDPE

Nominal Size (mm)	Part Number	Dimensions (mm)		
		d1	de	H
40	3003905 <sup>▲</sup>	40	64	50
50	3003935 <sup>▲</sup>	50	74	58
63	3003936 <sup>▲</sup>	63	87	63
75	3003937 <sup>▲</sup>	75	103	65
110	3003938 <sup>▲</sup>	110	145	90

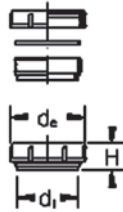

### Complete Closing Cap

Material: HDPE

Nominal Size (mm)	Part Number	Dimensions (mm)		
		d1	de	H
40	3003869	40	64	45
50	3003870	50	74	55
63	3003871 <sup>▲</sup>	63	87	40
75	3082542	75	107	38
90	3003872 <sup>▲</sup>	90	123	45
110	3003873	110	145	50

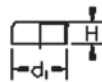

### Weld Cap

Material: HDPE

Nominal Size (mm)	Part Number	Dimensions (mm)	
		d1	H
40	3003860	40	38
50	3003861	50	38
56	3003874	56	38
63	3003862 <sup>▲</sup>	63	38
75	3003863	75	38
90	3003865 <sup>▲</sup>	90	40
110	3003866	110	45
125	3003867 <sup>▲</sup>	125	46
160	3003868	160	48

NOTE: <sup>▲</sup> = Made to order

# Wavin HDPE

## Product details **Soil, Waste and Vent**

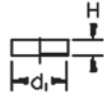

### Protection Cap for pipes and fitting

Material: HDPE

Nominal Size (mm)	Part Number	Dimensions (mm)	
		d1	H
40	3018704 <sup>▲</sup>	40	30
50	3018705 <sup>▲</sup>	50	30
63	3018706 <sup>▲</sup>	63	30
75	3018707 <sup>▲</sup>	75	30
90	3018708	90	31
110	3018709	110	33
125	3018710 <sup>▲</sup>	125	36
160	3018711 <sup>▲</sup>	160	36

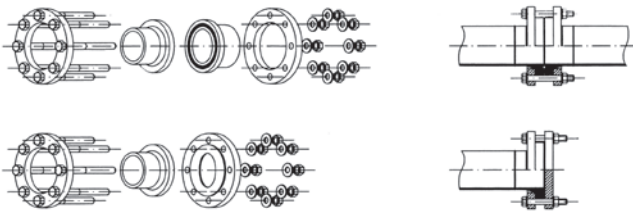

### Flange Connection

Material: HDPE



### Flange Adaptor

Material: HDPE

Nominal Size (mm)	Part Number	Dimensions (mm)			
		d1	de	h	H
50	4025986 <sup>▲</sup>	50	88	17	60
63	4025988 <sup>▲</sup>	63	102	19	65
75	4025989 <sup>▲</sup>	75	122	21	70
110	4009748	110	158	24	80
125	4009749 <sup>▲</sup>	125	188	24	80
160	4009750 <sup>▲</sup>	160	212	24	85
200	4009751 <sup>▲</sup>	200	268	24	140
250	4025992 <sup>▲</sup>	250	320	27	145
315	3018031 <sup>▲</sup>	315	370	27	145



### Galvanised Steel Flange 1"

Material: Steel

Nominal Size (mm)	Part Number
1"	4009793

NOTE: <sup>▲</sup> = Made to order



### Brass Nut Connection

Material: HDPE

Nominal Size (mm)	Part Number	Dimensions (mm)		
		d1	G	H
40 x ¾"	3003908 <sup>▲</sup>	40	¾"	60
40 x 1"	3003910 <sup>▲</sup>	40	1"	60
40 x 1¼"	3003912 <sup>▲</sup>	40	1¼"	60
40 x 1½"	3003913 <sup>▲</sup>	40	1½"	60
50 x ¾"	3003917 <sup>▲</sup>	50	¾"	75
50 x 1¼"	3003921 <sup>▲</sup>	50	1¼"	60
50 x 1½"	3003924 <sup>▲</sup>	50	1½"	60
50 x 2"	3003927 <sup>▲</sup>	50	2"	60
63 x 2"	4009761 <sup>▲</sup>	63	2"	82

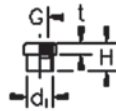

### Internal Thread Joint

Material: HDPE

Nominal Size (mm)	Part Number	Dimensions (mm)			
		d1	G	t	H
50	3003925 <sup>▲</sup>	50	1 - ½"	22	55

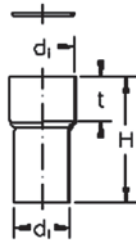

### Shrink-on Socket with Seal

Material: HDPE

Nominal Size (mm)	Part Number	Dimensions (mm)					
		d1	di	t	H	Ø connection	
50	3003516 <sup>▲</sup>	50	68	80	250	45 ÷ 60	
63	3018026 <sup>▲</sup>	63	91	85	250	60 ÷ 82	
75	3018027 <sup>▲</sup>	75	100	90	250	70 ÷ 92	
90	3018028 <sup>▲</sup>	90	111	100	250	85 ÷ 102	
110	3003528 <sup>▲</sup>	110	132	90	250	105 ÷ 124	
125	3018029 <sup>▲</sup>	125	156	100	250	120 ÷ 148	
160	3018030 <sup>▲</sup>	160	180	100	250	155 ÷ 172	
200	3018025 <sup>▲</sup>	200	220	100	250	195 ÷ 212	

NOTE: <sup>▲</sup> = Made to order



# Wavin HDPE

## Product details **Soil, Waste and Vent**



### Electrofusion Welding Tool DUO "315"

- Supplied with two different welding cables, which must be used as follows:
  - Dimension 40 – 160mm: green welding cable
  - Dimension 200 – 315mm: brown welding cable
- Observe the installation and processing instructions when using the welding tool

Description	Part Number
Electrofusion welding tool DUO 315	4036330

*\*The DUO "315" electrofusion welding tool is for creating longitudinal frictional joints. The tool is designed exclusively for welding Wavin Duo and Geberit\* brand, or Geberit compatible (Valsir, Coes, Vulcathene, Eurofusion, Aakatherm, Polypipe)\* electrofusion sockets (\*up to max. 160mm).*



### Electrofusion Welding Tool

- 230V

Description	Part Number
Electrofusion Welding Tool 110v	4064999



### Electrofusion Welding Tool Cable

Description	Part Number
40-160 Spare, for use with 4064999	4065001



### Electrofusion Welding Tool Cable

Description	Part Number
200-315 Spare, for use with 4064999	4065000



### Heat Reflector Butt-Welding Tool

Description	Part Number
VR 160, 40 – 160mm	4011398



### Heat Reflector Butt-Welding Tool Media 250

Description	Part Number
Media 250, 75 – 250mm	4011401 <sup>▲</sup>



### Welding Mirror Complete with metal case

- Manual thermostat
- Teflon coating
- Maximum power consumption 800w
- Power supply 220~50Hz

Class	Description	Welding Diameter	Part Number
X1	TP200	160	4011403



### Heat Reflector Butt-Welding Tool Maxi 315

Description	Part Number
Maxi 315, 90 – 315mm	4011402 <sup>▲</sup>



### PE Pipe Cutter

DN (mm)	Part Number
40 – 63	4026014 <sup>▲</sup>
50 – 125	4011390
110 – 160	4011393
200 – 315	4011396

NOTE: <sup>▲</sup> = Made to order

# Wavin HDPE

## Product details **Soil, Waste and Vent**



### HDPE Rotary Peelers

Description	Part Number
for pipe 50mm	4042914
for pipe 63mm	4024493
for pipe 75mm	4024569
for pipe 90mm	4024432
for pipe 110mm	4024189
for pipe 125mm	4024393
for pipe 160mm	4024190
Replacement blade	4066330



### Other Processing Aids

Description	Part Number
PE marker pen China Marker	4011453
PE pipe scraper	4020757
PE cleaner 0.7 litre bottle	4025509

# Wavin HDPE

## Assembly

### 2. Assembly

Wavin HDPE soil and waste systems are designed to convey soil and waste safely away from appliances to a soil stack or drain. The system is suitable for above ground sanitary fittings and appliances in domestic, commercial and public buildings.

#### 2.1 General

##### 2.1.1 Pipework in the waste removal system

Wavin HDPE soil and waste systems are designed to convey soil drainage and waste safely away from appliances to a soil stack or drain. The systems are suitable for above ground sanitary fittings and appliances in domestic, commercial and public buildings.

Wavin HDPE soil and waste systems should be designed and installed in accordance with the guidance provided in the appropriate sections of the following:

- ① Building Regulations 2000 (England and Wales): Approved Document H, Part H1
- ① Building Standards (Scotland) Regulations 1993-2002 (including current amendments: Technical Standards Part M)
- ① Building Regulations (Northern Ireland) 2000: Technical Booklet N
- ① BS 8000 Workmanship on Building Sites: Part 13: 1989 Code of Practice for above ground drainage and sanitary appliances
- ① BS EN 12056: 2000 Gravity drainage systems inside buildings
- ① Painting plastics: IP 11/1979. Watford, BRE 1979
- ① Water Regulations Guide: London, Water Regulations Advisory Scheme, 2000
- ① BS EN 752:2008 – Drain and sewer systems outside buildings

##### 2.1.2. Brackets

Most types of support brackets can be used including; light nylon band brackets, light or heavy PVC brackets to galvanised sewer brackets, and suspension bands. Ensure that any sliding brackets do actually slide (avoid over-tightening). Brackets used for clamping must be of suitable strength. For fixed point brackets (only with HDPE) galvanised steel brackets must be used.

##### 2.1.3. Storage

Rubber O-rings must be kept in a cool, dark place and not exposed to sunlight (not even behind glass). Pipes must be stored as flat as possible to prevent sagging. Keep pipes as clean as possible; this saves time when preparing and making connections. Covering the pipes is recommended during extended storage outdoors to avoid the pipes warping. Oval pipes create extra work when welding joints. Leave accessories in the packaging as long as possible. HDPE electroweld sleeves should be stored indoors and left as long as possible in the packaging to prevent oxidation from sunlight.

##### 2.1.4 Oval pipe ends

If the HDPE pipe ends become oval they should first be rounded off. This can be achieved by clamping the pipe with a bracket with a piece of padding between, placed back from the eventual coupling insertion depth at the end of the pipe. The brackets are only removed after the weld has cooled.

##### 2.1.5 Shortening of pipes

The best and simplest method is to use a pipe cutter. This ensures that the cut is then straight and no burrs are generally created. If a saw is used, care needs to be taken to ensure that the cut is straight: mark the cut, use a stiff saw blade and use a work bench with  $\varnothing$  above 50mm. Remove internal and external burrs with steel wool or a knife. For sawing HDPE use a fairly coarse-toothed blade with a wide set.

### 2.2 Jointing

Joints fall in principle into two categories, those resistant to tension and those not resistant to tension. Heat welded and flanged joints are resistant to tension. Expansion sockets and connections using rubber seals are not resistant to tension. HDPE pipes cannot be joined using solvent cement. However heat welding of HDPE gives excellent results. This creates a tension-resistant connection. There are two methods of heat welding: butt welding and electro-welding using fittings with integral heating elements.

#### 2.2.1 Principles of heat fusing polyethylene pipes and fittings

The Wavin HDPE range contains pipes, spigot fittings and electrofusion sockets. Pipes and fittings (both electro fusion couplers and spigot fittings) are provided with external marking ribs or marking stripes enabling easy alignment particularly in pre-fabrication.

For correct heat fusion of polyethylene, the following basic requirements must be met in order to obtain good quality joints.

1. Sufficient heat
2. Sufficient pressure
3. Sufficient welding & cooling time
4. "Clean to clean" material

In the two most common applied welding techniques, electrofusion and butt-welding, these parameters are dependent on the design of the electrofusion socket and/or in the welding procedure.

# Wavin HDPE

## Assembly

### 2.2.2 Butt-welding

Butt-welding is a very economical jointing technique. Correctly made butt-welds maintain the strength of the pipe. Well-trained personnel are recommended for making butt-welds.

In butt welding, two pipe ends, two fitting ends or a pipe end and a fitting end are bonded by melting the circular pipe faces simultaneously and pressing these together. Butt-welding can only be performed using a butt-welding machine.

The butt-welding procedure incorporates the following 15 steps:

1. **Check environmental conditions.**  
When the outside temperature is below 5°C and/or during rainy and windy conditions, special precautionary measures have to be taken to ensure dry and sufficiently warm welding conditions.
2. **Check the welding machine is in good functional order.**  
At least the following issues should be checked: temperature, alignment, play of the moving parts, smooth movement of the moving parts, electrical connections, cutting machining plate (sharpness).

Step 2

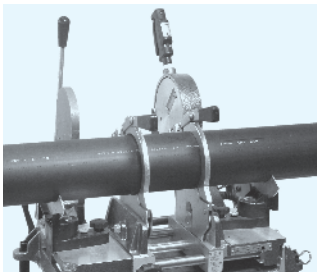

Step 3



3. **Clean the heater plate with HDPE cleaner and a soft cloth.**  
Prevent any damage of the Teflon coating.
4. **Check the temperature heater plate is at 210°C.**
5. **Cut pipe to required length.**  
Note: take into account that in the welding process a few millimetres of pipe will be consumed. Best practice is to use a rotary pipe cutter. The pipe ends are then square and free from burrs. If a saw is used, it is advised to use a spare clamp as a sawing guide. Cut pipe ends must be de-burred before placing in the welding machine.

Step 4

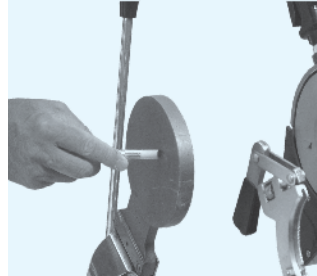

Step 5

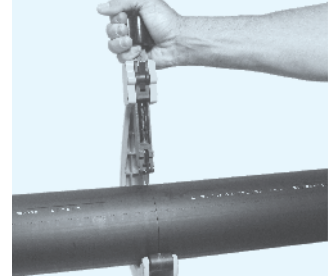

6. **Clamp both pipe-ends in the welding machine and ensure correct alignment.**  
Eliminate any bending forces if present.
7. **Trim both pipe-ends using the planer.**  
Keep the planer running whilst slowly reducing pressure. Do not stop the planer when still in contact with the pipe ends in order to prevent uneven surfaces.

Step 6

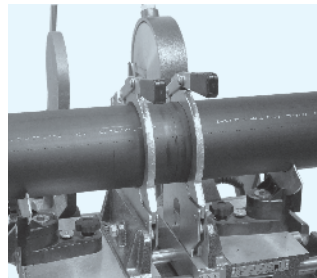

Step 7

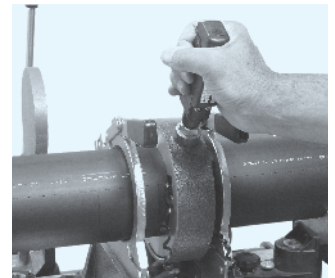

8. **Check that the pipe ends are matching.**  
If not correct either by re-clamp the pipe (alignment) and/or repeat trimming. After re-clamping it is necessary to trim the pipe-end again with a planer.
9. **Insert the heater plate and press both pipe ends for a few seconds with a higher force on the plate to ensure full contact.**
10. **Reduce the force until nearly zero, ensuring contact with the heater plate so that heat is soaked into both pipe ends.**

Step 8

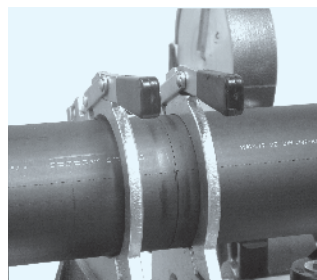

Step 9 and 10

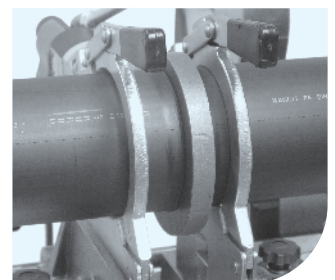

11. Maintain heat soaking until a bead is formed of approximate 1mm for diameters 40 up to 200 and 1.5mm for diameters 250 and 315mm.

Use the figures mentioned in table 2 as guidance for the heat soaking duration.

12. After the heating time is elapsed, quickly open the welding machine, remove the heater plate and close immediately. This part of the welding operation must be kept as short as possible in order not to loose too much heat!

**Step 12**



Table 2: Guidance of the heat soaking duration (in seconds) for butt-welding.

Dimensions mm	Time (approx.) s
40	30
50-110	40
125	60
160	80
200	100
250	140
315	170

Table 2a: Guidance of the minimum cooling time (in seconds) for butt-welding at 20° C.

Dimensions mm	Time (approx.) s
40-75	60
90	70
110	80
125	100
160	120
200	200
250	260
315	340

13. Slowly apply welding force and maintain for required cooling time according to table 2a.

14. Inspect weld bead for evenness.

Uneven weld beads indicate incorrect alignment or out of roundness. Large weld beads could be caused by either too high a heater temperature and/or too high a welding force. A small weld bead could be caused by a too low a heater temperature and/or too low a welding force. In both cases the weld should be rejected due to reduced strength.

15. Remove welded joint from the welding machine after cooling time is elapsed.

The joint needs to be kept free from any loads within 5 minutes after the cooling time is elapsed. If the above steps are followed correctly, the above mentioned four basic requirements should be fully met.

**2.2.3. Electro fusion**

Electro fusion couplers are fitted with a resistance wire. Heat will be applied to the welding zones using appropriate welding equipment. The polyethylene expands during the fusion process. This expansion ensures that the necessary welding pressure is generated. Wavin welding equipment automatically supplies the precise amount of heat required for a perfect weld. One type of electro weld equipment is available (see product range).

**Overview electro fusion machines and couplers**

Equipment type	Weld zone	Electro fusion couplers for use in jointing
WaviDuo Machine	40 – 315	WaviDuo couplers
Type No. 4700.200		

**Electro fusion couplers, weld time (approx.)**

*Note: the data given in the following table is approximated, since weld times are dependent on ambient temperature and are a function of the welding equipment used. The data given in the table is relevant to ambient temperatures of 23°C and 230V supply.*

**WaviDuo electro fusion coupler**

Dimensions mm	Weld time (approx.) s
40 – 160	82
200 – 315	370

**Using electroweld equipment**

Always read the manufacturer’s operating instructions and the contents of DVS 2207 before using pipe collar welding equipment. Where no operating instructions are available please contact the Wavin Technical Office.

# Wavin HDPE

## Assembly

### Installation: Required tools:

- ⦿ Pipe cutter
- ⦿ Circumferential measuring tape
- ⦿ Rotary peeler or hand scraper
- ⦿ HDPE cleaner
- ⦿ Lint-free, colorless and clean cloth
- ⦿ Measuring tape
- ⦿ Permanent marker
- ⦿ 230VAC power supply
- ⦿ Welding machine, suitable for WAVIDUO couplers (DUO 315)
- ⦿ Pipe clamp if appropriate

### NOTICE – Faulty pipe connection

Insufficient preparation and not following the installation instructions may lead to a faulty pipe connection. The functioning and life-time of the system and the connection may be affected. Please adhere to the instructions in this installation manual and the operating instructions provided with the welding machine.

The pipe ends must be cut precisely. The pipe ends should be fully inserted until the marked position on the pipes. Failing to adhere to the welding instructions can lead to overheating of the pipe connection during the welding process and in extreme cases lead to a fire hazard.

**NB: Never weld a WAVIDUO electro fusion coupler twice. A faulty connection must be cut out and be replaced by a new coupler.**

### General

With wet and cold conditions on site, take special precautions in order to create a working environment that is sufficiently dry and warm.

When installing the system, the maximum acceptable temperature range is -10°C to +40°C.

### Electro fusion jointing procedure

1. Clean the pipe roughly in the circumferential direction, cut precisely square with the pipe cutter and de-burr the edges. Cut off obvious reversed pipe ends.
2. Check the fusion ends with a circumferential measuring tape before and after the peeling operation. Adhere to standards and specifications (EN 12666-1). (See Table 3).
3. Measure the length of the coupler with a measuring tape to calculate the peeling length. The formula for the peeling length:  $(\text{coupler length} / 2) + 10\text{mm}$ . In case of use as a sliding coupler or repair coupler the peeling length is equal to the length of the coupler. Remove centre stop with a knife.

### Step 3



### Step 4



4. Measure the area which must be peeled with a measuring tape on the pipe and mark with a permanent marker.
5. Peel the pipe with a rotary peeler or hand scraper past the marking. Do not use sand paper. Ensure that the complete surface of the peeling area is peeled sufficiently. Minimum peeling thickness is 0.2mm. (See Table 3).

### Step 5

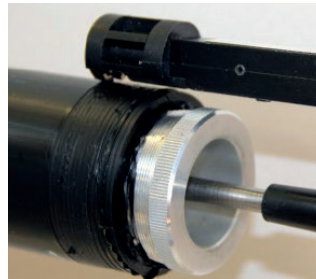

### Step 6



6. Clean the peeled area of the pipe with HDPE cleaner using a clean, lint-free, colourless cloth in a circumferential direction and let the cleaner evaporate.
7. Always mark the insertion depth with a permanent marker on the pipe. Formula for the insertion depth:  $(\text{coupler length} / 2)$ .
8. Clean the inside of the electro fusion coupler with HDPE cleaner using a clean, lint-free, colourless cloth in a circumferential direction and let the cleaner evaporate until coupler is free of residues.

### Step 7



### Step 8



9. Correct marking allows complete control over fully inserting the pipe and movements of pipe and fittings during the welding process.
10. Ensure a low stress installation. Secure pipe and electro fusion coupler to avoid movement. If appropriate, use pipe clamps to hold the system in place.
11. Follow the instructions on the display of the welding machine. Control and supervise the fusion process. Do not touch the electro fusion coupler during the fusion process and the cooling time as it will be very hot.

**Step 9**



**Step 11**

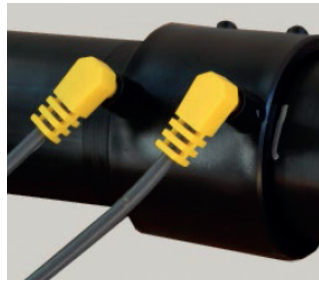

12. During and after fusion, check the message on the display of the fusion unit. When the fusion is successful, remove the fusion cables. Check the fusion indicators on the coupler. Both indicators have to be visible. If not, the coupler must be cut out and a new coupler should be installed. Defective connections must not be welded twice!

**Step 12 Before**



**Step 12 After**

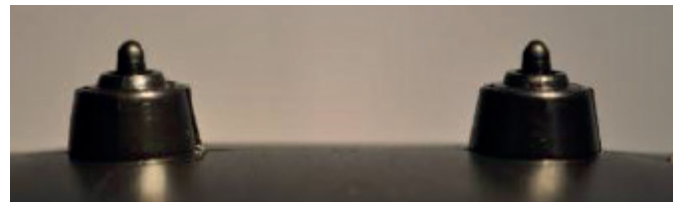

13. Make sure you have a low stress installation. Secure the pipe and electro fusion coupler against movements (i.e. using pipe clamps) and keep fixed and still until cooling time has elapsed.

Table 3. Minimum wall reduction by peeling 0.2mm

Diameter Ø	d40	d50	d56	d63	d75	d90	d110	d125	d160	d200	d250	d315
Min. pipe Ø [mm]	39.6	49.6	55.6	62.6	74.6	89.6	109.6	124.6	159.6	199.6	249.6	314.6
Cooling Time [min]	10	10	10	10	15	15	15	15	15	20	20	20



# Wavin HDPE

## Installation

### 3. Installation

#### 3.1 Installation using flexion legs / expansion bends

Due to the elastic modulus of polyethylene, any temperature related changes in length can be absorbed using flexion legs.

Figure 1: Installation using flexion legs

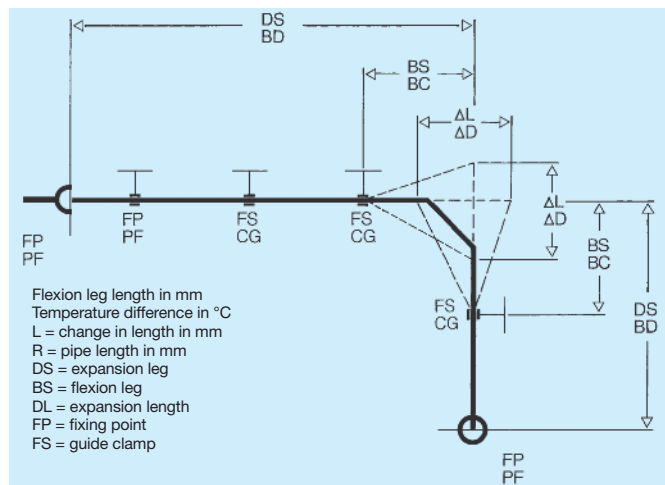

Flexion leg length (BS) is given by

- ① The change in length (DL) of the expansion leg (DS)
- ① HDPE piping external diameter

Temperature-related changes in HDPE pipe length (DL) are transferred to the flexion legs by the guide clamp fixing points (FP).

The following parameters are used to determine flexion leg length in the diagram above (Fig. 2):

- ① Average coefficient of linear expansion of PE – HD = 0.2 mm/m °C
- ① Flexion leg:  $\sqrt{de \times \Delta L}$   
de = external diameter  
L = change in length

Figure 2: Calculation of flexion leg length

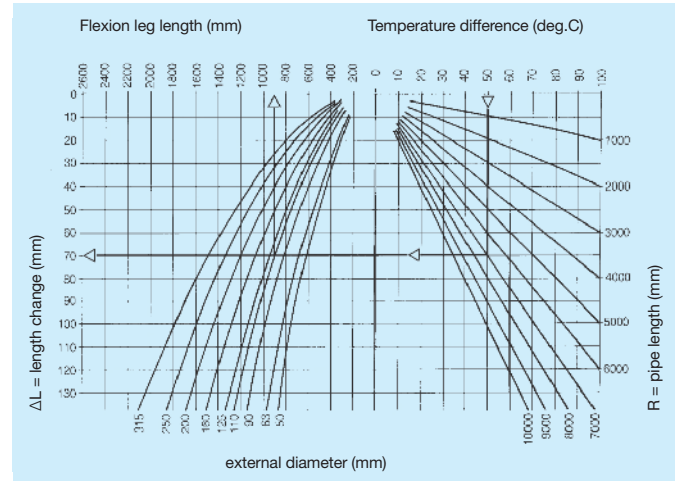

#### 3.2 Operation, treatment and installation of expansion sockets

Expansion sockets are used for taking up expansion on applications where flexion legs cannot be installed.

Long collars should be fixed rigidly to the supporting structure. The fixtures (clamps) must be capable of withstanding the forces applied during pipe installation and subsequent sliding movements. The forces applied during pipe installation are those generated when pushing together the tapered pipe ends. The sliding resistance is the ability of the long pipe collar to withstand the effects of temperature-related changes in the length of the pipe.

Table 4: Installation force and sliding resistance

Dimensions mm	Installation forces	Sliding resistance under operating conditions
de	N	N
50 – 63	200	100
75	250	120
90	300	200
110	400	300
125	550	400
160	800	700
200	1200	1000
250	1800	1500
315	2600	2200

**Installation**

Figure 3: Chamfering in pipe ends

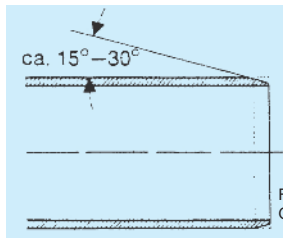
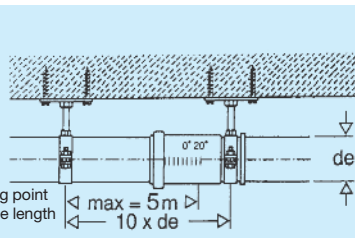

Figure 4: Fixing a long pipe collar



Pipe ends should be evenly chamfered to an angle of approximately 15°. Use silicone lubricant on the spigot end as this allows the pipe end to be inserted with minimum resistance.

The expansion socket is designed to support a maximum pipe length of 6m. The appropriate number of long pipe collars must therefore be calculated when supporting longer pipe runs. Mark off the required insertion depths, chamfer the male pipe ends and use lubricant.

Figure 5: Insertion length as a function of installation temperature

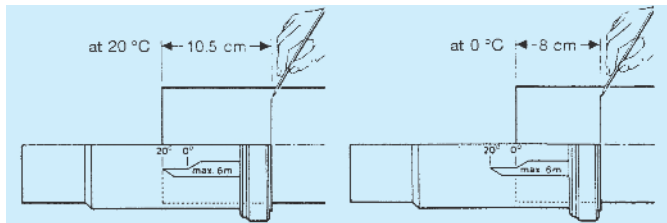

The insertion lengths required are dependent on the temperature of the surroundings during installation. Installation temperatures of 20°C require insertion lengths of 10.5cm; installation temperatures of 0°C require only 8cm insertion lengths.

**Note:** Refer to 'push-in depth' table on page 20.

**Fixation**

The ceiling plates and pipe clamps to be used will be dependent on the size of the wall or ceiling gap, L, and the pipe diameter.

Choose the appropriate ceiling plate or disc to match the gap, L.

The section modulus, W, should be calculated where the value of L is large. The following formula can be used:

$$W = L \cdot K/s$$

W = section modulus in cm<sup>3</sup>

L = Wall or ceiling gap (cm)

K = Sliding resistance (kp) in Newtons (N) – see table 6

s = allowable bending stress of the fixture in kg/cm<sup>2</sup> (2000 kg/cm<sup>2</sup>)

Table 5. Threaded pipe (fittings) as a function of wall and ceiling gap

Wall or ceiling gap L (mm)	d50-90	d110	d125	d160	d200	d250	d315
100	1/2"	1/2"	1/2"	-	-	-	-
150	1/2"	1/2"	1/2"	1/2"	-	-	-
200	1/2"	1/2"	1/2"	1/2"	3/4"	1"	-
250	1/2"	1/2"	1/2"	3/4"	1"	1"	5/4"
300	1/2"	1/2"	1/2"	3/4"	1"	5/4"	5/4"
350	1/2"	1/2"	1/2"	1"	1"	5/4" 1	1/2"
400	1/2"	1/2"	3/4"	1"	1"	5/4" 1	1/2"
450	1/2"	1/2"	3/4"	1"	5/4" 1	5/4" 1	1/2"
500	1/2"	3/4"	3/4"	1"	5/4"	1 1/2"	2"
550	1/2"	3/4"	3/4"	1"	5/4"	1 1/2"	2"
600	1/2"	3/4"	1"	1"	5/4"	1 1/2"	2"

# Wavin HDPE

## Installation

### 3.3 Rigid installation of open-mounted HDPE piping

Wall or ceiling-mounted piping should be installed under the following rigid fixing point (FP) conditions.

The fixtures (fixing points) must be capable of withstanding the often substantial forces generated by pipe expansion and contraction.

Table 6: Sliding resistance in N

Dimensions mm	Ring surface	Assumed temperature difference	
		ca. +20°C – +90°C Sliding resistance	ca. +20°C – -20°C Sliding resistance
d	cm <sup>2</sup>	N	N
56	5.0	1250	3150
63	5.6	1288	2528
75	6.8	1700	4280
90	9.5	2375	5985
110	14.0	3500	8820
125	18.5	4600	11650
160	29.6	7400	18650
200	37.7	9400	23750
250	59.5	14900	37500
315	93.9	23500	59150

### 3.4 Securing using fixed points

The fixed points used for rigid installation must be capable of withstanding much greater expansion forces than those occurring in the case of installations where expansion sockets or expansion legs and elbows are used. Pipes with diameters of up to 160mm can be secured using clamps with G ½" threaded collars with fittings and mating pipes to G 2" (see Table 7).

When using 5/4"-2" please contact a specialist mounting installation company to solve any unusual issues or calculations.

Table 7. Threaded pipe (fittings) as a function of wall and ceiling gap.

Wall or ceiling gap L (mm)	d50-56	d63-75	d110	d125	d160
100	½"	¾"	1"	1"	1 ¼"
150	¾"	1"	1"	1 ¼"	1 ¼"
200	¾"	1"	1 ¼"	1 ½"	1 ½"
250	1"	1"	1 ¼"	1 ½"	2"
300	1"	1 ¼"	1 ¼"	2"	2"
350	1 ¼"	1 ¼"	1 ½"	2"	2"
400	1 ¼"	1 ¼"	1 ½"	2"	–
450	1 ¼"	1 ½"	2"	2"	–
500	1 ¼"	1 ½"	2"	–	–
550	1 ¼"	1 ½"	2"	–	–
600	1 ½"	1 ½"	2"	–	–

Table 8: Actual weight of the loaded piping

de mm	kg/m	Weight N/m
50	1.940	16
56	2.440	20
63	3.080	26
75	3.380	38
90	6.388	55
110	9.500	100
125	12.290	120
160	20.150	200
200	31.240	310
250	48.820	490
315	77.500	780

Figure 6: Examples of anchor point attachment

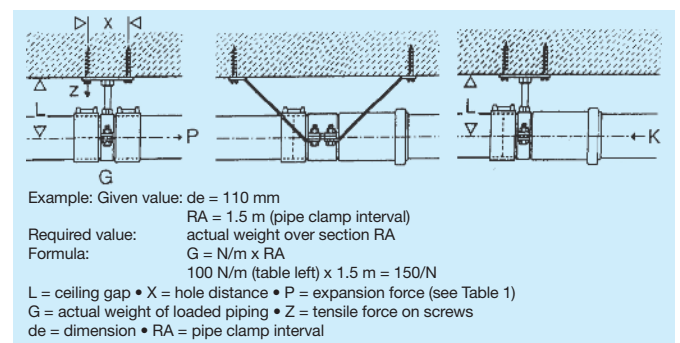

Reduction collars can be used to achieve the required diameters. Fixings used must be capable of withstanding the actual weight of the loaded piping and the resulting tensile forces generated by expansion.

### 3.5 Installation of expansion joints

Expansion joints are push-fit sockets with a rubber seal. Expansion and contraction in the pipe system is absorbed by axial displacements in the sockets. Normally expansion joints are mostly located in the vertical downpipes. In special circumstances, if no other options remain to absorb thermally induced displacements, expansion joints can be positioned in horizontal collector pipes.

#### Step 1

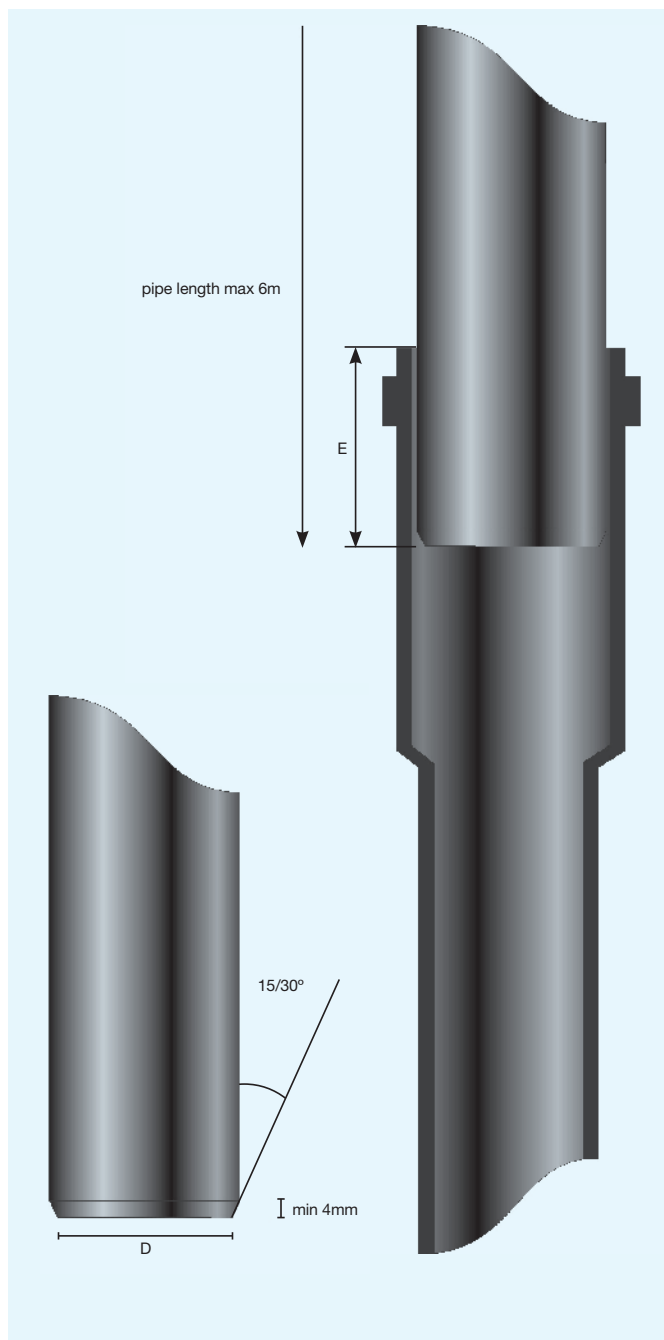

For the expansion joints to function correctly, follow these instructions:

- 1. Prepare the positions of fix-and sliding brackets**  
Expansion sockets must always be configured as a fixed-point. That means that all other fixing points must be sliding brackets.
- 2. Chamfer the pipe end**  
The chamfer angle should be approximately 15° and chamfering length should be minimum 4mm.

#### Step 2

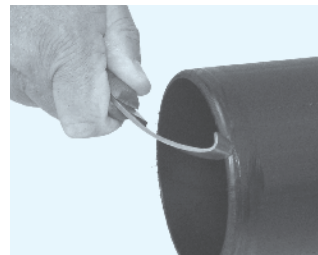

#### Step 3

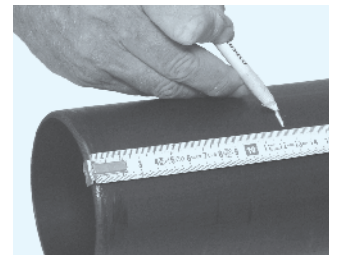

- 3. Mark insertion depth**  
Use the insertion depth for the ambient temperature during installation according to the values mentioned in table 9.

#### Step 4



- 4. Apply silicone lubricant on the rubber seal and sparsely on the spigot end**

#### Step 5



- 5. Install the pipe and fix with a fixed-point bracket on the socket side and sliding brackets over the rest of the pipe length**
- 6. Check the depth of insertion**

# Wavin HDPE

## Installation

Table 9. Insertion depth of the pipes into an expansion socket, max. pipe length 6m

Ambient temperature	Pipe diameter mm									
	≤ 50	63	75	90	110	125	160	200	250	315
	Insertion depth in [mm] for pipe length of 6m									
-10°C	65	70	70	80	85	90	100	140	140	140
0°C	75	80	80	90	95	100	110	150	150	150
+10°C	85	90	90	100	105	110	120	160	160	160
+20°C	95	100	100	110	115	120	130	170	170	170
+30°C	105	110	110	120	125	130	140	180	180	180

### 3.6 Installation of Wavin fire protection sleeves

#### 3.6.1 Product description

The 'EDS Collar' is a fire protection sleeve designed to prevent the spread of fire, smoke and hot gases through plastic pipes which penetrate fire compartment walls and floors. They are suitable for any type of building including timber frame where a fire compartment wall or floor is penetrated by a plastic pipe exceeding 40mm overall diameter. The 'EFS Collar' is approved to UNI EN 13501 2: 2009 & EI 120-180 Classification.

Figure 7: Wavin 'EFS' fire collars



#### Advantages

- ⊕ Installation speed thanks to the closing tab system
- ⊕ Seals against the passage of fumes, gases, flames and heat
- ⊕ Can be inserted inside of the wall in situations where space is limited
- ⊕ No tools are required

#### Size and characteristics of pipes

- ⊕ The 'EFS Collar' is available from 40ø - 250ø
- ⊕ They can be used on various materials, eg. PVC, PP, PE
- ⊕ No special tolerances are required on the diameter of pipe

#### Remarks

The intumescent material that forms the inner part of the collars is made up of graphite interlaced mineral fibre.

#### Applications

The 'EFS Collar' is suitable for maintaining the fire resistance of masonry walls and concrete floors which are penetrated by plastic pipework forming part of a drainage or ventilation system. They can be used in timber floor constructions where the ceiling lining has a fire rated resistance of at least one hour. They can be used on all types of new or refurbished buildings and are especially useful in residential flats, apartments, offices, hospitals, schools etc.

When subjected to heat the intumescent material reacts producing an insulating barrier of carbonaceous char or foam which expands inwards exercising a pressure and thus compressing the softened pipe to form an effective insulating plug which provides an effective seal against fire, smoke and hot gases.

Figure 8: CSI 1686FR Floor

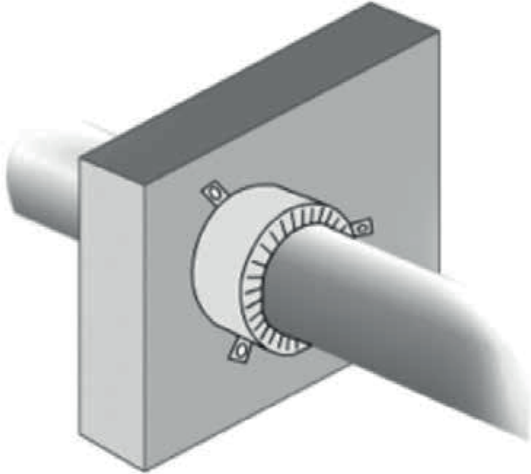
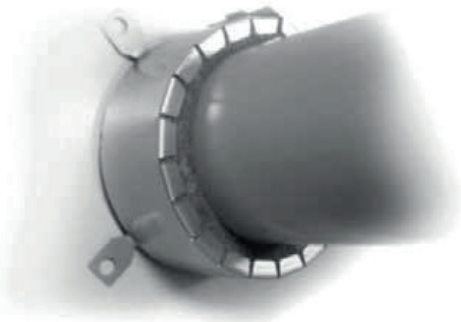

Figure 9: IG 308725/3577FR Wall



### 3.6.1.1 Installation instructions

#### Collar Installation

The 'EFS Collar' can be fixed before or after the installation of the pipes and operate horizontally or vertically. For horizontal pipework where there is a fire risk from each side of the wall the unit should be installed within the thickness of the wall or if this is not possible one unit should be fitted to each side of the wall.

Figure 10: Collar Installation (One side of wall)

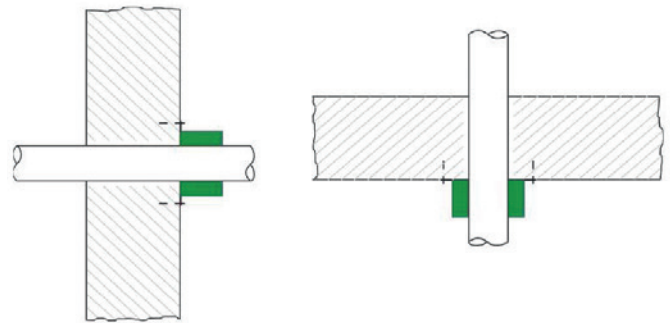
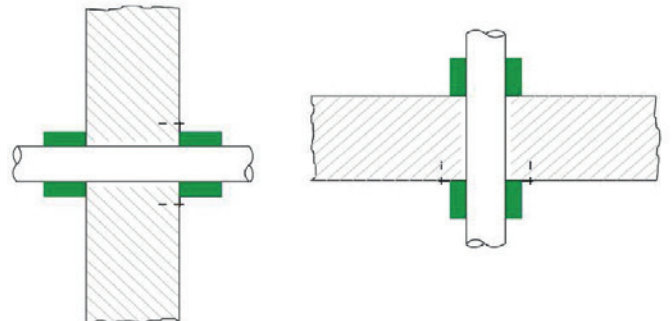

Figure 11: Collar Installation (Both sides of wall)



# Wavin HDPE

## Installation

### Preparing the wall / floor

Create a hole in the wall / floor that is at least 2mm larger than the outer diameter of the pipe that will be used.

### Installation of the pipe

Insert the pipe inside the hole.

### Closing and sealing against the passage of smoke and gas

In the event of any gaps between the pipe and wall / floor it is necessary to fill the hole with a suitable fire resistant material, this avoids the passage of fumes in the event of a fire.

### Cleaning the pipe

The expansion of the intumescent material inside the collar completely closes the plastic pipes through a mechanical action. If the pipes are very dirty and have, for example, mortar residues, this action is delayed. It is therefore necessary to clean the surface of the plastic pipes at the point where the fire collars are installed.

### EFS Collar Installation

Wrap the pipe with the EFS collar and close it with the special tabs located at the end. NB: The collar should be applied from the side which is exposed to the fire.

### EFS Collar Fixing

Once the EFS collar is positioned, attach it to the wall or floor using the supplied fixings. It is important not to use non-fire resistant fixings e.g. plastic. NB: The number of screws varies according to the diameter of the collar. NB: Only if properly secured is the fire collar EFS able to perform its function against the passage of fire.

Table 10.

Collar Cat. No.	SAP Code	Adaptor for pipe ø	Number of fixings	Collar Height mm
309 175	4063766	40	3	30/50
309 176	4063767	50	3	30/50
309 177	4063768	63	3	30/50
309 178	4063769	75/78	3	30/50
309 179	4063770	90	3	50
309 184	4026438	110	4	50
309 185	4026439	125	4/5	50/70
309 190	4063772	160	5	50/70
309 187	4026441	200	5	100
309 188	4026442	250	5	100

### 3.7 Wavin HDPE Airmix “Sovent” fitting

The Airmix “Sovent” fitting from Wavin is an ideal solution to reduce pressure fluctuations and to prevent installing an additional ventilation stack.

#### 3.7.1 Introduction

In our daily life a large volume of soil & waste water is being produced by toilets, bath, showers, dishwashers and washing machines. All this waste water has to be drained from the buildings and transported to the sewage facilities. A single drainage pipe would be capable of draining a certain amount of waste water. However, large pressure peaks do appear, blowing out all water traps and giving access for bad odours to enter the home.

To keep the pressure fluctuations low, the system has to be ventilated and an additional ventilation stack can do the work. But this additional ventilation stack is more complicated in construction, costs considerably more and takes up more valuable space in the building shafts.

Figure 12: Airmix “Sovent” fitting



The Wavin HDPE Airmix “Sovent” fitting prevents all this. The principle of this fitting is based on keeping a free path air to leave or to enter the system and thereby keeping the pressure level within acceptable limit.

It interrupts the fall of the waste water on every floor resulting in a reduction of speed. The vent pipe is obsolete and the unique design increases the capacity of the riser.

This fitting will be delivered with closed caps. After removing the caps the required branches can be butt welded on the fitting.

#### 3.7.2 Benefits

The Wavin HDPE Airmix “Sovent” offers the following benefits in comparison with conventional systems:

- ④ **One special fitting offers 6 connections**  
Gives multiple connections per floor
- ④ **Single stack system**  
No separate ventilation pipes required.
- ④ **Space savings**  
Reduced stack sizes with the same loading capacities as a secondary ventilated system gives extra space for other installations
- ④ **Cost savings**  
Installation time and material saved
- ④ **Lower speed**  
Reduces the hydraulic pressure

#### 3.7.3 Applications

The Wavin HDPE Airmix “Sovent” is an ideal drainage system fitting that can be used for:

- ④ Hotels
- ④ Universities, schools
- ④ High-rise buildings
- ④ Hospitals
- ④ Laboratories
- ④ Industrial plants



# Wavin HDPE

## Installation

### 3.8 Casting in heat cured concrete and extrusion shrinkage

HDPE pipework gives excellent results when cast into concrete floors and walls. Concrete is sometimes brought to very high temperatures in order to allow shuttering to be struck the following day, particularly in tunnelling work. The temperature gauge controlling the burners may sometimes be defective. Sometimes the control of the burners is carried out using the outermost tunnel sections, because these cool most rapidly. The temperature in the enclosed tunnel may then be higher. Extrusion shrinkage becomes significant for plastic pipework in these circumstances. Extrusion shrinkage is measured when the pipe is heated and then cooled. The limits are set down in the standards against set temperatures, and are for HDPE: at 110°C max. 3%. The pipe will expand during heating of the liquid concrete. The degree of expansion is limited as the pipework is fixed at various points and (the mass of) the concrete restricts expansion. Once the concrete has hardened the pipe will shrink due to thermal shrinkage and extrusion shrinkage. This is resisted by the hardened concrete as the pipework is held fast by bends, sleeves, T-pieces and similar, so that tensile forces arise in the pipe. The tensile forces give rise to concentrations of stress which may lead to breakage. T-pieces are particularly susceptible to stress concentrations. The degree of extrusion shrinkage depends on the maximum temperature achieved.

The temperature of the pipes may be no higher than 80 to 90°C to cut out all risk. Since the variation in temperature in the concrete can be fairly great, it is stipulated that the measured temperature shall be no higher than 50 to 60°C. Higher temperatures are in any case not good for the quality of the concrete.

HDPE pipes for above-ground drainage are sometimes “tempered” for safety reasons. That means that they are heat treated during or following manufacture (extrusion), largely removing extrusion shrinkage.

### 3.9 Cast-in pipework

Pipework cast into concrete can be regarded as rigidly installed. Any welded joints in HDPE must be allowed to cool first. It is recommended that the pipework is pressure tested and checked for leaks before the concrete is poured. The pipework must be fixed well to prevent flotation during pouring. With HDPE the bracket separation is around 8 x D (min. 0.75 metre, max. 1.5 metre). If pipework is cast vertically in concrete (e.g. columns, walls) the liquid concrete will produce an external overpressure.

In order to calculate the external overpressure in kPa the height in metres of liquid concrete must be multiplied by 24. If the pipe is filled with water to counteract flotation the multiplication factor is 14.

Example: 6 metres of liquid concrete, pipe Ø 110mm without water filling, pressure  $6 \times 24 = 144$  kPa.

With water filling the external overpressure is  $6 \times 14 = 84$  kPa.

Table 11.

SDR Du/e	HDPE			Calculated resistance (kPa)
	HDPE pipe size			
13.3	40x3 50x3;	63x3.6;	75x4.3	635
17	90x5.1; 160x9.1;	110x6.3; 200x11.4	125x7.1	348
21	63x3 75x3;	90x3.5;	110x4.3	178
26	125x4.9; 200x7.7	160x6.2;		92
30	90x3			58
32	110x3.5; 160x5.0;	125x3.9; 200x6.2		50

# Wavin HDPE

## Construction, Testing and Maintenance

### 4. Situations During Construction

Damage and movement of the installed waste removal system must be avoided during construction.

Possible measures include:

- ④ Closing off pipework with protective caps. Use caps that fit over the pipe wherever possible so that they are not accidentally left in place. When using caps that fit within pipes, this should be clearly indicated
- ④ Seal off spigot ends that are still to be connected
- ④ Expansion socket sleeves in vertical pipework should be protected from materials such as mortar that might get into the sleeve
- ④ Protect around 20mm of pipe ends emerging vertically from concrete floors by sealing with a suitable material prior to pouring concrete. This often prevents damage when the floor is worked on later
- ④ Ensure adequate anchoring to prevent flotation or bending of pipes during concrete pouring
- ④ Check direction and height of pipework before ceilings or ducts are installed
- ④ Pressure test pipework before pouring concrete
- ④ Prevent grit from roofs entering waste pipework. This can be extremely difficult to flush out and can give rise to problems especially with rubber seals

### 5. Pressure Testing

On completion of any installation work, the systems should be inspected and tested in accordance with BS EN 12056 and Part H of The Building Regulations.

Air testing is the preferred form of leak detection. The use of smoke testing of plastic pipework should be avoided.

### 6. Maintenance

A well-designed, properly installed and correctly used waste removal system will require little or no maintenance. Inadequacies in design and installation, and incorrect discharge activities may cause poor or slow removal of water or a blockage. Usually no action is taken until the water begins to drain slowly or there is a complete blockage. Checks on drainage and periodic maintenance are therefore recommended. In the event of blockages or threatened blockages which are not located in the traps, a clearing spring may be used. Care must be taken to prevent damage, especially in bends. High pressure cleaning with a jet head is a better approach. The use of explosive charges to cause pressure shocks in the pipes is not recommended.

Specialist firms may carry out major maintenance or the clearing of serious blockages. It is useful to build in a number of cleansing facilities to aid cleaning or removal of blockages:

- ④ Removable traps
- ④ Connections to underground pipes with rubber sleeves
- ④ Access fittings at strategic points such as at the transition from underground pipework to the domestic pipework, around hydraulic problem areas such as after a series of bends and with longer pipe runs, and in cast-in pipework

Access fittings must be accessible and where possible be located higher than the horizontal pipework, or higher than the discharge level of fittings. This means that a section of the blocked pipework does not need to empty through the opened access fitting. Where the access fitting cap is more than around 100 to 150mm from the exterior of the pipe, the use of a 45° fitting is recommended. Obstruction of drainage from roofs, gutters, gullies, overflows, rainwater drainage and other drainage constructions must be prevented by means of periodic maintenance.

Special attention must be paid to drainage where granular roof coverings are installed after the drainage system is in place. Grit which enters horizontal pipework is difficult to flush away using the normal speed of flow, and encourages fouling. Flushing clean before handover and after around a year is strongly recommended.

# Wavin HDPE

## Chemical Resistance

### 7. Chemical Resistance

The data in this list is intended only as a guide for planning purposes and are not automatically applicable to all conditions of use. Considerable deviations can occur dependent on type of exposure and probable contamination of the chemical medium. Wavin cannot be held liable for any special, indirect or consequential damages irrespective of whether caused or allegedly caused by negligence. No warranty can be derived concerning the data mentioned.

#### Symbols used in the table:

- + resistant
- 0 limited resistance only
- not resistant

SA saturated, aqueous solution

T customary in trade

TP technically pure

D diluted

*No symbol means no testing, unknown*

Chemical resistance	Concentration	PE-HD Temperature °C.		
		20	40	60
acetaldehyde	TP	+	0	0
acetic acid	60%			
acetic acid	10%	+	+	+
acetic acid	25%			
acetic acid	60–95%			
acetic anhydride	TP	+		0
acetone	TP	+	+	0
acetophenone	TO	+		-
acrylonitrile	TO	+	+	+
adipic acid	SA	+	+	+
air	-	+	+	+
allyl alcohol	96%	-	+	+
aluminium chloride	SA	+	+	+
aluminium fluoride	SA	+	+	+
aluminium sulphate	SA	+	+	+
alums	SA	+	+	+
ammonia, aqueous	SA	+	+	+
ammonia, fluid	TP	+	+	+
ammonia, gaseous	TP	+	+	+
ammonium acetate	SA			
ammonium carbonate, and bi	SA			
ammonium chloride	SA	+	+	+
ammonium fluoride	>10%	+	+	+
ammonium fluoride	20%			
ammonium fluoride	SA			
ammonium hydroxide	SA			
ammonium nitrate	SA	+	+	+
ammonium phosphate, also meta	SA	+	+	+
ammonium sulphide	SA	+	+	+
amyl acetate	TP	+	+	0
amyl alcohol	TP	+	+	0
aniline	SA			
aniline	TP	+	+	
oaniline chlorhydrate	SA	+	+	+
anisole	TP	0	-	-
anthraquinone sulphonc acid, suspension	SA			
antimony trichloride	90%	+	+	+
apple juice	T	+	+	+
aqua regia (HCl / HNO3)	03:01	-	-	-
arsenic acid	SA	+	+	+
barium salts	SA	+	+	+
beer	T	+	+	+
benzaldehyde	0.1%			
benzaldehyde	TP	+	+	0
benzene	TP	0	0	0
benzine (cleaning benzine)	T	+	+	0
benzine -super (gas fuel)	T	+	+	0
benzine-benzene mixture	80/20			
benzoic acid	SA	+	+	+
benzoyl chloride	TP	0	0	0
benzyl alcohol	TP	+	+	0
borax	D			
borax	SA	+	+	+
boric acid	SA	+	+	+

Chemical resistance	Concentration	PE-HD Temperature °C.		
		20	40	60
		brandy	T	
bromic acid	10%			
bromine vapour	-			
bromine, fluid	TP	-	-	-
bromine, gaseous, dry	TP	-	-	-
butadiene	TP	o		-
butane, gaseous	TP	+	+	+
butanol	TP	+	+	+
butyl acetate	TP	o		-
butyl glycol (butandiol)	TP	+		
butyl phenol	SA			
butyl phenol	TP			
butyl phthalate	TP	+		o
butyric acid	20%			
butyric acid	TP	+	+	o
calcium carbonate	SA	+	+	+
calcium chlorate	SA	+	+	+
calcium chloride	SA	+	+	+
calcium hydroxide	SA	+	+	+
calcium hypochloride	SA	+	+	+
calcium nitrate	50%			
calcium nitrate	SA	+	+	+
calcium sulphate	SA	+	+	+
calcium sulphite	SA	o	o	o
camphor oil	TP	-	-	-
carbon dioxide	100%	+	+	+
carbon dioxide, gaseous, wet/dry	TP	+	+	+
carbon disulphide	TP	o	-	-
carbon monoxide	TP	+	+	+
carbon tetrachloride	TP	o	-	-
carbonic acid	SA			
castor oil	TP	+	+	+
caustic soda, see sodium hydroxide solution		+	+	+
chlorthanol	TP	+	+	+
chlorinated lime, slurry	-	+	+	+
chlorine, fluid	TP	-	-	-
chlorine, gaseous, dry	TP	o	-	-
chloroacetic acid	85%	+	+	+
chloroacetic acid	TP			
chloromethane	TP	o	-	-
chlorosulphuric acid	D			
chlorosulphuric acid	TP	-	-	-
chrome alum	SA	+	+	+
chromic acid	1-50%	+	o	o
citric acid	D			
citric acid	SA	+	+	+
coconut oil	TP			
copper chloride	SA	+	+	+
copper cyanide	SA			
copper nitrate	30%			
copper nitrate	SA	+	+	+
copper sulphate	SA	+	+	+
copper fluoride	2%			

Chemical resistance	Concentration	PE-HD Temperature °C.		
		20	40	60
		corn germ oil	TP	
cottonseed oil	TP			
cresole	up to 90%	+	+	+
cresole	> 90%	+	+	o
creylic acid	SA			
crotonaldehyde	TP	+		o
cyclohexane	TP			
cyclohexanol	TP	+	+	+
cyclohexanon	TP	+		o
decahydronaphtalene (decalin)	TP	+		o
developer	T	+	+	+
dextrin	D	+	+	+
dibutyl phthalate	TP	+	o	o
dichloroacetic acid	TP	o	o	o
dichloroethylene	TP			
dichloromethane (methylene chloride)	TP	o		-
diethanolamine	TP	+		
diethylether	TP	o		
diglycolic acid	30%			
diglycolic acid	SA	+	+	+
diisooctyl phthalate	TP	+	+	o
dimethylamine	30%			
dimethylamine	TP			
dimethylformamide	TP	+	+	o
dioctyl phthalate	TP	+		o
dioxane	TP	+	+	+
disodium phosphate	SA			
ethanediol	TP	+	+	+
ethanol	40%	+		o
ethanol	TP	+	+	+
ethanolamine	TP			
ether, see diethyl ether		o		
ethyl acetate	TP	+		-
ethyl chloride, mono and di	TP			
ethyl glycol, see ethanediol		+	+	+
flax oil	TP	+	+	+
fluoric acid	40%			
fluoric acid	70%	+	+	o
fluoride	TP	-	-	-
fluorosilicic acid	40%	+	+	+
formaldehyde (formalin)	40%	+	+	+
formic acid	1-50%	+	+	+
formic acid	TP	+	+	+
fructose	T	+	+	+
fruit juices	T	+	+	+
furfuryl alcohol	TP	+	+	o
gelatin	D	+	+	+
glacial acetic acid	TP	+		o
glucose	20%			
glucose	SA	+	+	+
glucose	D	+	+	+
glycerine	TP	+	+	+
glycolic acid	30%			
glycolic acid	SA	+	+	+

# Wavin HDPE

## Chemical Resistance

Chemical resistance	Concentration	PE-HD Temperature °C.		
		20	40	60
		+	o	-
heptane	TP	+	o	-
hexadecanol	TP			
hexane	TP	+	o	o
hydrobromic acid	SA	+		
hydrochloric acid	10%			
hydrochloric acid	SA			
hydrocyanic acid	10%	+	+	+
hydrogen	TP	+	+	+
hydrogen bromide	50%	+	+	+
hydrogen bromide	TP	+	+	+
hydrogen chloride, damp	TP	+	+	+
hydrogen chloride, dry	TP			
hydrogen peroxide	30%	+	+	+
hydrogen peroxide	90%	+	o	-
hydrogen sulphide	100%	+	+	+
hydrogen sulphide	SA			
hydrogen sulphide	TP	+	+	+
iodine tincture	T	+		o
i-propanol, see isopropanol		+	+	+
iron II chloride	SA	+	+	+
iron II sulphate	SA	+	+	+
iron III chloride	SA	+	+	+
iron III nitrate	D	+	+	+
iron III sulphate	SA	+	+	+
isopropanol	TP			
isopropylether	TP			
lactic acid	10%			
lactic acid	TP	+	+	+
lanolin (wool lipids)	T	+	o	o
lead acetate	SA	+	+	+
lead tetraethyl	TP	+		
magnesium carbonate	SA	+	+	+
magnesium chloride	SA	+	+	+
magnesium hydroxide	SA	+	+	+
magnesium nitrate	SA	+	+	+
magnesium sulphate	SA			
maleic acid	SA	+	+	+
malic acid	SA			
mercury	TP	+	+	+
mercury chloride	SA	+	+	+
mercury cyanide	SA	+	+	+
mercury nitrate	D	+	+	+
methanol (methyl alcohol)	TP	+	+	o
methyl acetate	TP	+	+	
methyl bromide	TP	o		-
methyl ethyl ketone	TP	+		o
methyl methacrylate	TP			
methylamine	up to 32%	+		
methylene chloride, see dichloromethane		o	-	-
milk	T	+	+	+
mineral oils	T	+	+	o
mineral water	T	+	+	+
molasses	T	+	+	+
muriatic acid	up to 35%	+	+	+

Chemical resistance	Concentration	PE-HD Temperature °C.		
		20	40	60
		+	+	+
muriatic acid	20%			
muriatic acid, dilute	conc.	+	+	+
naphtha	T	+	-	-
naphthalene	TP			
nickel salts	SA	+	+	+
nicotinic acid	D	+	+	
nitric acid	10%			
nitric acid	25%	+	+	+
nitric acid	up to 40%	o	o	-
nitric acid	10-50%	o	o	-
nitric acid	more than 50%			
nitric acid	75%	-	-	-
nitric acid	98%			
nitrobenzene	TP	+	o	o
n-propanol	TP	+	+	+
oils and fats (vegetable/animal)	-	+	o	o
oleic acid	TP	+	+	+
olive oil	TP	+	+	o
oxalic acid	SA	+	+	+
oxygen	TP	+	+	o
ozone	TP	o	-	-
paraffin oil	TP	+	o	o
peanut oil	TP	+		
peppermint oil	TP	+		
perchloric acid	10%			
perchloric acid	20%	+	+	+
perchloric acid	70%			
perhydrol, see hydrogen peroxide 30%		+	+	+
petrol ether	TP	+	o	o
phenol	D	+	+	+
phenol, dilute	90%			
phenylhydrazine	TP			
phenylhydrazine chlorohydrate	TP			
phosphine	TP			
phosphoric acid	50%	+	+	+
phosphoric acid	up to 85%	+	+	o
phosphorus trichloride	TP	+	+	o
phosphoryl chloride	TP	+	+	o
picric acid	SA	+	+	
potable water, chlorinated	TP	+	+	+
potash, see potassium nitrate		+	+	+
potassium bichromate	40%			
potassium bichromate	SA	+	+	+
potassium borate	SA			
potassium bromate	SA	+	+	+
potassium bromate	10%			
potassium bromide	SA	+	+	+
potassium carbonate and bi	SA	+	+	+
potassium chlorate	SA	+	+	+
potassium chloride	SA	+	+	+
potassium chromate	40%	+	+	+
potassium cyanide	>10%	+	+	+
potassium cyanide	SA			
potassium fluoride	SA	+	+	+

Chemical resistance	Concentration	PE-HD		
		Temperature °C.		
		20	40	60
potassium hexacyanoferrate (II+III)	SA	+		+
potassium hydroxide	60%	+	+	+
potassium hydroxide	up to 50%	+	+	+
potassium hydroxide solution, see potassium hydroxide				
potassium hypochloride	D	+		o
potassium iodide	SA	+	+	+
potassium nitrate (potash)	SA	+	+	+
potassium orthophosphate	SA	+	+	+
potassium perchlorate	1%			
potassium perchlorate	10%			
potassium perchlorate	SA	+	+	+
potassium permanganate	SA			
potassium permanganate	20%	+	+	+
potassium persulphate	SA	+	+	+
potassium sulphate	SA	+	+	+
potassium sulphide	D	+	+	+
propane, gaseous	TR	+	+	
propionic acid	50%	+	+	+
propionic acid	TP	+	o	o
pyridine	TP	+	o	o
saccharic acid	SA			
salicylic acid	SA	+	+	+
sea water	T	+	+	+
sea water, see ocean water				
silicone oil	TP	+	+	+
siliconic acid	D	+	+	+
silver acetate	SA	+	+	+
silver cyanide	SA	+	+	+
silver nitrate	SA	+	+	+
soap	D			
soda, see sodium carbonate				
sodium acetate	SA	+	+	+
sodium benzoate	SA	+	+	+
sodium bicarbonate	SA	+	+	+
sodium biphosphate	SA	+	+	+
sodium borate	SA			
sodium bromide	SA	+	+	+
sodium carbonate	SA	+	+	+
sodium chlorate	SA	+	+	+
sodium chloride	SA	+	+	+
sodium chlorite	20%			
sodium cyanide	SA	+	+	+
sodium dichromate	SA	+	+	+
sodium fluoride	SA	+	+	+
sodium hexacyanoferrate (II + III)	SA	+	+	+
sodium hydrogen sulphite (sodium bisulphite)	SA	+	+	+
sodium hydroxide solution	up to 60%	+	+	+
sodium hydroxide, see sodium hydroxide solution				
sodium hypochloride	13%	+	+	+
	active chlorine			
sodium nitrate	SA	+	+	+
sodium nitrite	SA	+	+	+
sodium orthophosphate	SA	+	+	+

Chemical resistance	Concentration	PE-HD		
		Temperature °C.		
		20	40	60
sodium perborate	SA	+		o
sodium phosphate	SA	+	+	+
sodium silicate (water glass)	D	+	+	+
sodium sulphate and bi	SA	+	+	+
sodium sulphide	SA	+	+	+
sodium sulphite	40%			
sodium thiosulphate	SA	+	+	+
soy bean oil	TP	+	o	o
sulphur	D	+	+	+
sugar	SA	+	+	+
sulphur dioxide, dry, wet	TP	+	+	+
sulphur dioxide, fluid	TP			
sulphur trioxide	TP	-	-	-
sulphuric acid	up to 10%			
sulphuric acid	10-80%	+	+	+
sulphuric acid	96%	o		-
sulphurous acid	SA			
sulphurous acid	30%	+	+	+
Superchloric acid, see perchloric acid				
table salt, see sodium chloride				
tannic acid (tannins)	D	+	+	+
tartaric acid	D	+	+	+
tartaric acid	SA			
tetrahydrofuran	TP	o	o	-
tetrahydronaphthalene (tetralin)	TP	o	o	-
thionyl chloride	TP	-	-	-
thiophene	TP	o	o	-
tin chloride II + IV	SA	+	+	+
toluene	TP	o	-	-
trichloroacetic acid	50%	+	+	+
trichloroethylene	TP	-	-	-
tricresyl phosphate	TP	+	+	+
triethanolamine	D	+		o
trimethylol propane	up to 10%			
turpentine oil	TP	o	o	o
urea	33%			
urea	>10%	+	+	+
urea	SA			
urine	T	+	+	+
vinegar (wine vinegar)	T	+	+	+
vinyl acetate	TP	+	+	o
whisky	T			
wine and spirits	T	+	+	+
wine vinegar	T	+	+	+
xylene	TP	o	-	-
yeast	D	+	+	+
yeast	SA			
zinc carbonate	SA	+	+	+
zinc chloride	SA	+	+	+
zinc oxide	SA	+	+	+
zinc sulphate	SA	+	+	+

# Wavin HDPE

## Packaging, Transport and Storage

### 8.1 Packaging

The packaging of Wavin domestic waste-water piping systems is both user-friendly and transportation-orientated. The packaging is designed to ensure maximum safety and easy storage and handling.

Figure 13: Unloading packaged waste-water piping

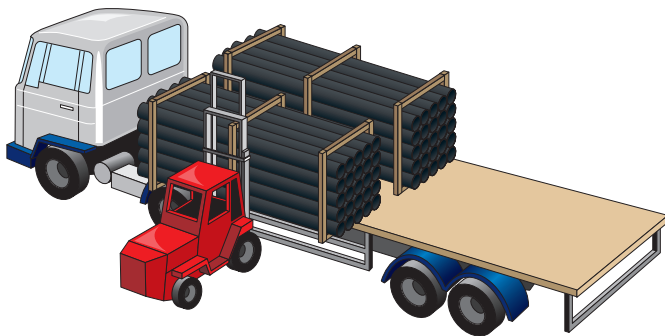

### 8.2 Transport

When loading and transporting Wavin domestic waste-water piping not still in its original packing, take care that the pipes are supported along their entire length to avoid them being bent. Arrange the pipes so that they lie with their end collars offset. Avoid subjecting the pipes to impact stress, particularly when temperatures are low.

When using machinery to load and unload packaged piping, ensure that the lifting forks are smooth and clean. Where this is not the case, support the packaging using nylon slings. Steel cables, chains, hooks and other metallic lifting gear must not be used.

Figure 14: Transporting loose Wavin waste-water pipes

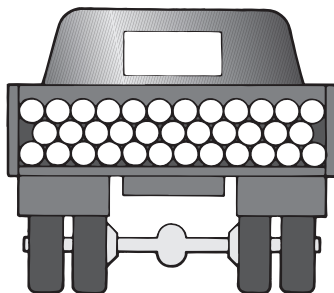

### 8.3 Pipe Storage

Pipe deformation or other forms of permanent damage must not be allowed to occur during storage. Factory-delivered piping pallets may be stacked to a height of 3 metres. Loose piping must be supported at the sides. Supports must be provided at least every 2 metres. This should be carried out using battens and crossbeams with a minimum section of 75mm.

**Caution:** Short-term pipe deformation can occur where pipe stacks are unevenly exposed to the effects of the sun (or other forms of heat). Pipes should not therefore be stored in direct sunlight.

Where it is not possible to store piping on completely level flooring, we recommend the use of a timber supporting frame with crossbeams positioned at maximum intervals of 1 metre (see diagram).

Figure 15: Pipes stored directly onto level flooring

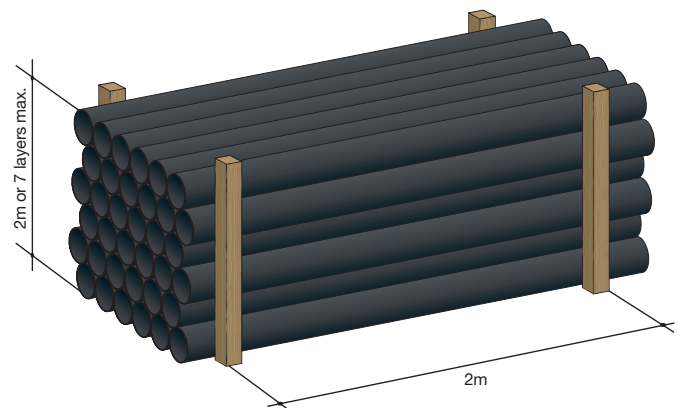
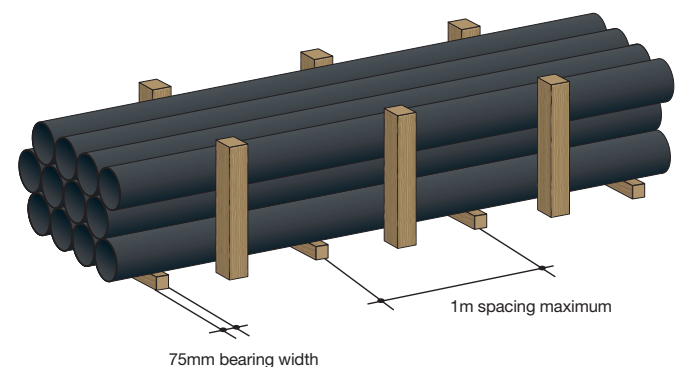

Figure 16: Pipes stored on timber supporting frame



### 8.4 Storing Moulded Fittings

Fittings should be kept in their factory-delivered packaging until required for use.

# Wavin HDPE

## General information

### References

Wavin Soil and Waste systems should be designed and installed in accordance with the guidance provided in the appropriate sections of the following:

- ⦿ Building Regulations 2000 (England and Wales): Approved Document H, Part H1
- ⦿ Building Standards (Scotland) Regulations 1993-2002 (including current amendments: Technical Standards Part M)
- ⦿ Building Regulations (Northern Ireland) 2000: Technical Booklet N
- ⦿ BS 8000 Workmanship on Building Sites: Part 13: 1989 Code of Practice for above ground drainage and sanitary appliances
- ⦿ BS EN 12056: 2000 Gravity drainage systems inside buildings: Part 3 Roof drainage, layout and calculation
- ⦿ Painting plastics: IP 11/1979. Watford, BRE 1979
- ⦿ Water Regulations Guide: London, Water Regulations Advisory Scheme, 2000
- ⦿ BS EN 752:2008 – Drain and sewer systems outside buildings
- ⦿ Wavin HDPE Soil and Waste Product and Installation Manual

Installation guidance and instructions where provided.

### Environment

All Wavin manufacturing sites operate Environmental Management Systems which comply with the requirements of and are certified to ISO 14001: 2004.

### Health and Safety

The relevant provisions of the following legislation should be adhered to on site:

- ⦿ Construction (Design and Management) Regulations 1994
- ⦿ Control of Substances Hazardous to Health Regulations 1988
- ⦿ Health and Safety at Work Act 1974
- ⦿ Management of Health and Safety at Work Regulations 1999
- ⦿ Manual Handling Operations Regulations 1992

### Hazards associated with PVC-U, PVC-C, Polypropylene and Polyethylene

There are no particular hazards associated with handling, cutting or working with the materials mentioned above, and protective clothing or equipment is not normally required.

Safety Data Sheets covering PVC-U, PVC-C, PP, PE, lubricant, solvent cements and cleaners are available from the Wavin Technical Design Department, please call Technical Enquiries to obtain a copy.

### Abbreviations

Key	
P/E:	Pipe and fittings with both ends plain or with one plain end and one special end
S/S:	Pipe and fittings with one or more ring-seal or push-fit sockets, but always one plain or special end
D/S:	Fittings with ring-seal or push-fit sockets at all ends
S/SW:	Fittings with one or more ring-seal sockets but always one solvent socket
SW/S:	Fittings with one or more solvent sockets and one plain or special end
D/SW:	Fittings with solvent sockets at all ends

### Supply

All systems are supplied through a nationwide network of merchant distributors. For details of your nearest merchant, contact Wavin Customer Services.

### Sealing Rings

Where applicable, Sealing Rings are supplied fitted to each component and are included in the price.

### Conditions of Sale

Wavin will not accept responsibility for the malfunction of any installation which includes components not supplied by Wavin. Goods are sold subject to Company conditions of sale.



# Wavin HDPE

## General Information

### Other Wavin Industrial and Commercial Systems

#### Tigris K1 Multilayer Press-fit System

High efficiency supply system for potable water, sanitary and heating applications.

- ⦿ Efficient installation, superlative performance
- ⦿ Advanced performance Hot & Cold plumbing system designed for potable, sanitary and heating applications in industrial, commercial and other large buildings
- ⦿ Fully-proven in Europe for over 10 years and now available for selection by specifiers and installers in the UK

#### Wavin AS+ Acoustic Soil System

A technologically advanced, push-fit soil system that delivers significant noise reduction over standard soil systems. The Astolan® material can absorb both structural and airborne sound.

- ⦿ Extremely lightweight, robust and corrosion-resistant
- ⦿ Fast and easy installation, saving time and cost – especially compared with cast iron alternative
- ⦿ Complies with Building Regulations, Part E
- ⦿ Wrapping of pipe not necessary to achieve noise reduction

#### Wavin PVC-U Compact Soil System

With its compact 110mm and 160mm soil fittings, the Wavin PVC-U Compact Soil System is particularly suitable for installation where space is at a premium

- ⦿ With both solvent-weld and push-fit connections
- ⦿ Branches available with rotating bases: enables connections in difficult-to-reach spaces
- ⦿ Innovative 'stop' position on fitting to prevent waste being installed with a fall less than 2.5°
- ⦿ Manufactured to BS EN 1329:2001 / BS EN 1453-1:2000

### Technical Advice

Wavin HDPE is backed by Wavin's comprehensive technical advice service. This is available to provide expert assistance at every stage of a project, from planning and product selection to installation and maintenance.

Contact Wavin Technical Design Department:

Tel: 0844 856 5165

Email: [technical.design@wavin.co.uk](mailto:technical.design@wavin.co.uk) or via online enquiry at [wavin.co.uk](http://wavin.co.uk)

### Literature

The following Wavin publications are also available from the Literature Department at Chippenham.

#### General

- ⦿ Wavin Above Ground Systems: Trade Price List

#### Above Ground Systems

- ⦿ Osma Soil and Waste: Product and Installation Manual
- ⦿ Tigris K1: Product and Installation Manual
- ⦿ Hep<sub>2</sub>O: Product Guide
- ⦿ Wavin Compact Soil: Product and Installation Manual
- ⦿ Wavin AS+ Acoustic Soil: Product and Installation Manual

To request details with regards to any of the above components and/or for any technical enquires please contact:

#### Literature Request

Tel: 01249 766333

Email: [literature@wavin.co.uk](mailto:literature@wavin.co.uk)

#### Technical Design

Tel: 0844 856 5165

Email: [technical.design@wavin.co.uk](mailto:technical.design@wavin.co.uk)

#### Wavin Online

The complete range of Wavin/Osma product and installation guides are also available online at: [wavin.co.uk](http://wavin.co.uk)

Did you know you can also download our BIM files, take e-learning courses and CPD's online at [myportal.wavin.co.uk](http://myportal.wavin.co.uk) and you can see installation tips on our YouTube channel WavinUK



## Discover our broad portfolio at [www.wavin.co.uk](http://www.wavin.co.uk)

Hot & Cold Water

Foul Water

Gas & Water Mains

Indoor Climate

Storm Water

Geotextiles

Soil & Waste

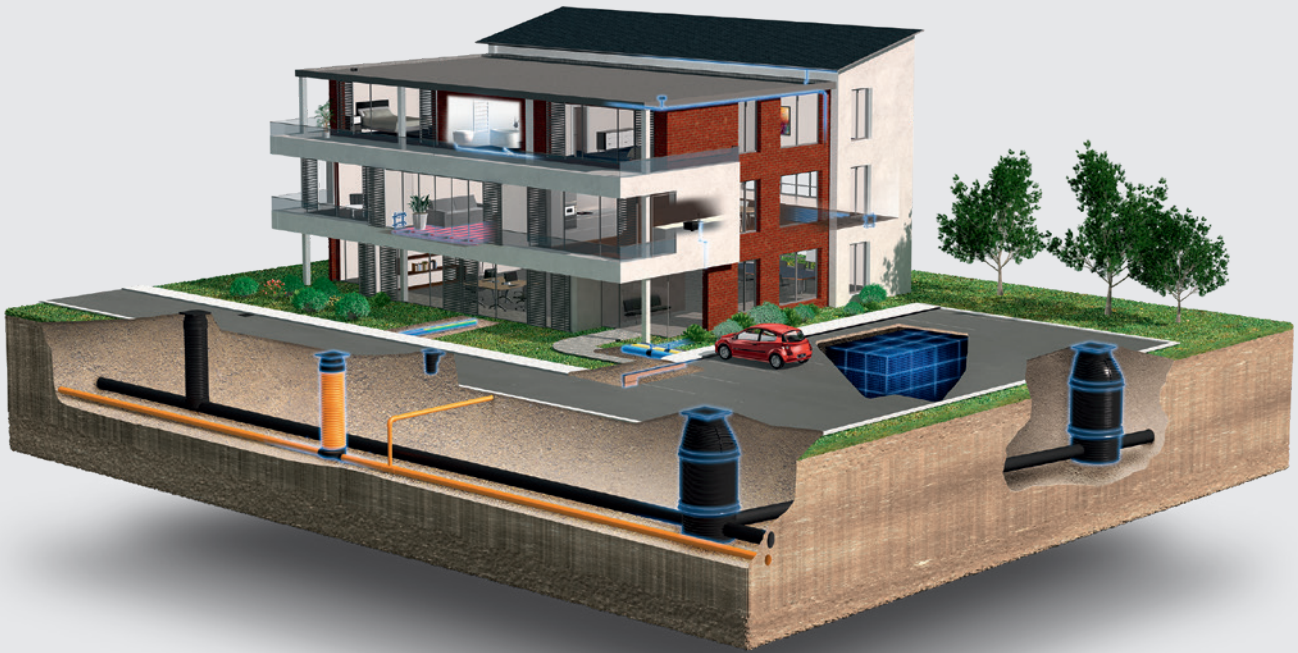

Wavin is part of Orbia, a community of companies working together to tackle some of the world's most complex challenges. We are bound by a common purpose: To Advance Life Around the World.



An Orbia business.

**Wavin Middle East** | Tiffany Tower No. 2408 W Cluster JLT | Dubai | United Arab Emirates  
Tel. 01 8020200 | [www.wavin.ie](http://www.wavin.ie) | [info.ie@wavin.com](mailto:info.ie@wavin.com)

Wavin operates a programme of continuous product development, and therefore reserves the right to modify or amend the specification of their products without notice. All information in this publication is given in good faith, and believed to be correct at the time of going to press. However, no responsibility can be accepted for any errors, omissions or incorrect assumptions.

© 2024 Wavin Wavin reserves the right to make alterations without prior notice. Due to continuous product development, changes in technical specifications may change. Installation must comply with the installation instructions.