

# Wavin Drainage and Sewer systems

for non-pressure underground  
drainage and sewer applications



# Contents

<b>1. Scope</b>	Page	4
<b>2. Pipe &amp; fittings – Product ranges</b>	Page	5
<b>2.1. Wavin KG</b>	Page	6
<b>2.2. Wavin X-Stream</b>	Page	14
<b>3. Chambers &amp; manholes – Product ranges</b>	Page	24
<b>3.1. Wavin IC range</b>	Page	25
<b>3.1.1. Wavin IC 315</b>	Page	26
<b>3.1.2. Wavin IC 400</b>	Page	28
<b>3.1.3. Wavin IC 450</b>	Page	30
<b>3.2. Wavin Tegra range</b>	Page	33
<b>3.2.1. Wavin Tegra 425</b>	Page	34
<b>3.2.2. Wavin Tegra 600</b>	Page	40
<b>3.2.3. Wavin Tegra 1000 NG</b>	Page	48
<b>4. Design information &amp; technical data</b>	Page	55
<b>4.1 Pipe &amp; fittings</b>	Page	55
<b>4.1.1. General</b>	Page	55
<b>4.1.2. Hydraulic performance</b>	Page	55
<b>4.1.3. Structural performance</b>	Page	57
<b>4.1.4. Chemical resistance</b>	Page	58
<b>4.2. Chambers &amp; manholes</b>	Page	59
<b>4.2.1. General</b>	Page	59
<b>4.2.2. Base units</b>	Page	59
<b>4.2.3. Shafts</b>	Page	59
<b>4.2.4. Manhole steps / ladders</b>	Page	60
<b>4.2.5. Top constructions</b>	Page	60
<b>5. Transport, handling &amp; storage</b>	Page	61
<b>5.1. General</b>	Page	61
<b>5.2. Transport</b>	Page	61
<b>5.3. Handling</b>	Page	61
<b>5.4. Storage</b>	Page	62
<b>5.5 Handling and storage inspection chambers &amp; manholes</b>	Page	62

<b>6. Installation of pipe &amp; fittings</b>	Page 63
<b>6.1. Safety</b>	Page 63
<b>6.2. Trench configuration</b>	Page 63
<b>6.3. Pipe laying</b>	Page 64
<b>6.4. Jointing</b>	Page 65
<b>6.4.1. Wavin KG</b>	Page 65
<b>6.4.2. Wavin X-Stream</b>	Page 66
<b>6.5. Backfilling &amp; compaction</b>	Page 67
<b>6.6. Fittings</b>	Page 68
<b>6.7. Connection to rigid structures</b>	Page 69
<b>7. Installation of chambers &amp; manholes</b>	Page 71
<b>7.1. Wavin IC range</b>	Page 71
<b>7.1.1. Wavin IC 315</b>	Page 71
<b>7.1.2. Wavin IC 400</b>	Page 72
<b>7.1.3. Wavin IC 450</b>	Page 72
<b>7.2. Wavin Tegra range</b>	Page 74
<b>7.2.1. Wavin Tegra 425</b>	Page 74
<b>7.2.2. Wavin Tegra 600</b>	Page 76
<b>7.2.3. Wavin Tegra 1000 NG</b>	Page 78
<b>7.3. Shaft inlets</b>	Page 80
<b>7.4. Backdrop configurations</b>	Page 81
<b>8. Inspection &amp; testing</b>	Page 82
<b>8.1. Tightness testing with water</b>	Page 82
<b>8.2. Tightness testing with air</b>	Page 82
<b>9. Standards &amp; certificates</b>	Page 84
<b>9.1. Standards related to sewers</b>	Page 84
<b>9.2. Certificates</b>	Page 85
<b>Annex 1 – Ladder assembly in Wavin Tegra 1000 NG</b>	Page 86
<b>Annex 2 – Top construction to Wavin Tegra chambers &amp; manholes</b>	Page 88

# 1. Scope

**Wavin is the leading supplier of plastic pipe systems in Europe and has over 55 years of experience in the development and production of innovative pipe and chamber systems for durable sewer structures. The comprehensive product range comprises gravity pipes, pressure pipes, fittings, inspection chambers and manholes that can be perfectly combined. Wavin sewer systems have enjoyed high demand for decades. In total, over 2 million Wavin chambers and manholes have been installed to date.**

This Technical Manual gives information on the use of Wavin sewer pipe systems, for buried applications, intended for:

- › non-pressure drainage & sewerage
- › non-pressure industrial effluent discharge

It provides information and guidance on:

- › product ranges and characteristics
- › quality assurance
- › pipeline design
- › handling & installation
- › applicable international standards.

## 2. Pipe & fittings

### Product ranges

**For the manufacture of pipes and fittings, raw material is supplied in the form of small uniform granules.**

The material is processed as a melt. This melt processing involves applying heat to the material, forcing it through a die or into a mould and stabilising the dimensions of the component by controlled cooling.

Pipes are produced by continuous extrusion, consisting of feeding the material into a heated barrel which incorporates a rotating screw. The rotation of the screw transports the granules along the barrel of the extruder, compacting and plasticising the material to form a homogeneous melt. The melt is then forced through a die, with a central mandrel which controls the nominal outside diameter and wall thickness of the pipe.

On leaving the die, the still pliable pipe is taken through a calibration and cooling stage where its final dimensions are formed and fixed.

Downline from the extruder is the multi-track haul-off unit, plus the marking, cutting and socketing equipment necessary to complete the final product.

Wavin stands for products that are safe and reliable in the long term. In order to guarantee top quality, the entire range is subject to continuous internal and external monitoring. The Wavin quality management is certified in accordance with ISO 9001:2000 and ISO 14001:2004. Wavin products have a service life up to 100 years.



*Figure 1: Pipe extrusion.*

Wavin offers a comprehensive range of sewer pipe systems, all manufactured from thermoplastics materials: Wavin KG made from PVC-U and Wavin X-Stream made from PP.

The traditional jointing method in sewer construction is the push-fit connection. The easy push-fit rubber ring jointing system is durable, corrosion free and light weight. The diameter varies from 110 to 800 mm.

# Wavin KG

## 2.1. Wavin KG

The Wavin KG sewer pipes and fittings are suitable for drain and underground sewer applications. This easy push-fit rubber ring jointing system is durable, corrosion free and light weight.

The orange/brown coloured Wavin KG pipes and fittings for underground drainage and sewerage are available in a range of 110, 125, 160, 200, 250, 315, 400, 500 mm OD. The smallest sizes from these ranges are also used for in-house soil, waste and vent applications. An extensive range is available to complete the system. The pipes have a stiffness SN 4 with a multi-layer wall configuration. Pipes with stiffness SN 8 are available on request.

The system is produced in accordance with EN 1401 / EN 13476 and in compliance with the respective ISO standards.



Relevant product standards	Selection of certificates
EN 1401 -1, -2, -3 EN 13476 -1, -2	Benor BSI DiBT KIWA

Table 1: Standards & Certificates Wavin KG.

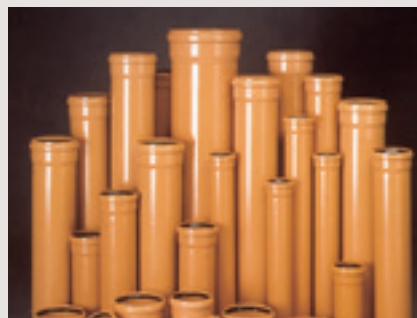

# Wavin KG Product range



**Wavin KG multi-layer pipe (KG-EM) SN4,  
Effective length = 5 m**

Dimensions	Article code
OD 110 mm	18929000
OD 125 mm	56928000
OD 160 mm	56952000
OD 200 mm	03014576
OD 250 mm	03079554
OD 315 mm	03079589
OD 400 mm	03079619
OD 500 mm	03079643



**Wavin KG Branch (KG-EA)**

Dimensions	Degree	Article code
OD 110/110 mm	45°	03065847
OD 110/110 mm	87°	03065855
OD 125/110 mm	45°	03065863
OD 125/110 mm	87°	03065871
OD 125/125 mm	45°	03065880
OD 125/125 mm	87°	03065898
OD 160/110 mm	45°	03065901
OD 160/110 mm	87°	03065910
OD 160/125 mm	45°	03065928
OD 160/125 mm	87°	03065936
OD 160/160 mm	45°	03065944
OD 160/160 mm	87°	03065952
OD 200/110 mm	45°	03065960
OD 200/110 mm	87°	03065979
OD 200/125 mm	45°	03065987
OD 200/125 mm	87°	03065995
OD 200/160 mm	45°	03066002
OD 200/160 mm	87°	03066010
OD 200/200 mm	45°	03066029
OD 200/200 mm	87°	03066037
OD 250/110 mm	45°	03066045
OD 250/110 mm	87°	03066053
OD 250/125 mm	45°	03066061
OD 250/125 mm	87°	03066070
OD 250/160 mm	45°	03066088
OD 250/160 mm	87°	03066096



\* fabricated

#### Wavin KG Branch (KG-EA) (continued)

Dimensions	Degree	Article code
OD 250/200 mm	45°	03066100
OD 250/200 mm	87°	03066118
OD 250/250 mm	45°	03066126
OD 250/250 mm	87°	03066134
OD 315/110 mm	45°	03066142
OD 315/110 mm*	87°	03066150
OD 315/125 mm	45°	03066169
OD 315/125 mm	87°	3012675
OD 315/160 mm	45°	03066185
OD 315/160 mm*	87°	03066193
OD 315/200 mm*	45°	03066207
OD 315/200 mm*	87°	03066215
OD 315/250 mm*	45°	03066223
OD 315/250 mm*	87°	03066231
OD 315/315 mm*	45°	03066240
OD 315/315 mm*	87°	03066258
OD 400/110 mm*	45°	03066266
OD 400/110 mm*	87°	03066274
OD 400/125 mm*	45°	03066282
OD 400/160 mm*	45°	03066304
OD 400/160 mm*	87°	03066312
OD 400/200 mm*	45°	03066320
OD 400/200 mm*	87°	03066339
OD 400/250 mm*	45°	03066347
OD 400/250 mm*	87°	03066355
OD 400/315 mm*	45°	03066363
OD 400/315 mm*	87°	03066371
OD 400/400 mm*	45°	03066380
OD 400/400 mm*	87°	03066398
OD 500/160 mm*	45°	03066428
OD 500/160 mm*	87°	03066436
OD 500/200 mm*	45°	03066444
OD 500/250 mm*	45°	03066460
OD 500/250 mm*	87°	03066479
OD 500/315 mm*	45°	03066487
OD 500/315 mm*	87°	03066495
OD 500/400 mm*	45°	03066509
OD 500/400 mm*	87°	03066517
OD 500/500 mm*	45°	03066525
OD 500/500 mm*	87°	03066533





\* fabricated

**Wavin KG Bend (KG-B)**

Dimensions	Degree	Article code
OD 110 mm	15°	03065480
OD 110 mm	30°	03065499
OD 110 mm	45°	03065502
OD 110 mm	67°	03065510
OD 110 mm	87°	03065529
OD 125 mm	15°	03065545
OD 125 mm	30°	03065553
OD 125 mm	45°	03065537
OD 125 mm	67°	03065561
OD 125 mm	87°	03065570
OD 160 mm	15°	03065588
OD 160 mm	30°	03065596
OD 160 mm	45°	03065600
OD 160 mm	67°	03065618
OD 160 mm	87°	03065626
OD 200 mm	15°	03065634
OD 200 mm	30°	3012622
OD 200 mm	45°	03065650
OD 200 mm	67°	03065669
OD 200 mm	87°	03065677
OD 250 mm	15°	03065685
OD 250 mm	30°	03065693
OD 250 mm	45°	03065707
OD 250 mm	87°	03065715
OD 315 mm	15°	03065723
OD 315 mm	30°	3012631
OD 315 mm	45°	03065740
OD 315 mm	87°	03065758
OD 400 mm*	15°	03065766
OD 400 mm*	30°	03065774
OD 400 mm*	45°	03065782
OD 400 mm*	87°	03065790
OD 500 mm*	15°	03065804
OD 500 mm*	30°	03065812
OD 500 mm*	45°	03065820
OD 500 mm*	87°	03065839



#### Wavin KG Single Socket (KG-AM)

##### Dimensions

OD 110 mm  
OD 160 mm

##### Article code

03071170  
03071189

---



#### Wavin KG Coupler (KG-MM)

##### Dimensions

OD 110 mm  
OD 125 mm  
OD 160 mm  
OD 200 mm  
OD 250 mm\*  
OD 315 mm\*  
OD 400 mm\*  
OD 500 mm\*

##### Article code

03066622  
03066630  
03066649  
03066657  
03066665  
03066673  
03066681  
03066690

\* fabricated

---



#### Wavin KG Repair Coupler (KG-U)

##### Dimensions

OD 110 mm  
OD 125 mm  
OD 160 mm  
OD 200 mm  
OD 250 mm\*  
OD 315 mm\*  
OD 400 mm\*  
OD 500 mm\*

##### Article code

03066541  
03066550  
03066568  
03066576  
03066584  
03066593  
03066606  
03066614

\* fabricated



\* fabricated

\*\* fabricated and only centric

#### Wavin KG Reducer (KG-R)

Dimensions	Article code
OD 125/110 mm	03067017
OD 160/110 mm	03067025
OD 160/125 mm	03067033
OD 200/160 mm	03067041
OD 250/200 mm*	03067050
OD 315/250 mm*	03067068
OD 400/315 mm*	03067076
OD 500/400 mm**	03067084



\* fabricated

#### Wavin KG Socket Plug (KG-M)

Dimensions	Article code
OD 110 mm	03066703
OD 125 mm	03066711
OD 160 mm	03066720
OD 200 mm	03066738
OD 250 mm	03069001
OD 315 mm	03069028
OD 400 mm	03069052
OD 500 mm*	03066770



\* fabricated

#### Wavin KG End Cap (KG-K)

Dimensions	Article code
OD 110 mm	03066789
OD 125 mm	03066797
OD 160 mm	03066800
OD 200 mm	03066819
OD 250 mm	03068935
OD 315 mm	03068951
OD 400 mm	03068986
OD 500 mm*	03066851



\* fabricated

#### Wavin KG Adaptor for Clay Pipe Spigot (KG-US)

Dimensions	Article code
OD 110 mm	34606000
OD 125 mm	34614000
OD 160 mm	34622000
OD 200 mm*	34630000



\* fabricated

#### Wavin KG Adaptor for Clay Pipe Socket (KG-USM)

Dimensions	Article code
OD 110 mm	31631000
OD 125 mm	31968000
OD 160 mm	32859000
OD 200 mm*	33863000



#### Wavin KG Adaptor for Cast Iron Spigot (KG-UG)

Dimensions	Article code
OD 110 mm	26581000
OD 125 mm	26590000
OD 160 mm	26603000
OD 200 mm	3009503

#### Wavin KG Lip Sealing Ring

Dimensions	Article code
OD 110 mm	24597000
OD 125 mm	24600000
OD 160 mm	3000177
OD 200 mm	4025477
OD 250 mm	24635000
OD 315 mm	24651000
OD 400 mm	24660000
OD 500 mm	31160000



**Protection Sleeve**

Dimensions	L	Article code
OD 110 mm	110	3164810100
OD 160 mm	110	3164810105
OD 200 mm	110	3164810110
OD 250 mm	110	3164810115
OD 315 mm	110	3164810120
OD 400 mm	110	3164810125
OD 110 mm	240	3164810130
OD 160 mm	240	3164810135
OD 200 mm	240	3164810140
OD 250 mm	240	3164810145
OD 315 mm	240	3164810150



**Wavin KG Access Pipe (KG-RE)**

Dimensions	Article code
OD 110 mm	03066860
OD 125 mm	03066878
OD 160 mm	03066886
OD 200 mm	03066894



**Inlet Connector**

Dimensions	Article code
200 x 125 mm	3003957
250 x 125 mm	3003958
315 x 125 mm	3003960
400 x 125 mm	3003962
250 x 160 mm	3003959
315 x 160 mm	3003961
400 x 160 mm	3003963
500 x 160 mm	3001399
630 x 160 mm	3001400

# Wavin X-Stream

## 2.2. Wavin X-Stream

The Wavin X-Stream system is a new generation of plastic pipes for drainage of foul water and storm water. No other system has ever had such tight, secure connections – and yet be so easy to push-fit and seal.

The Wavin X-Stream structured wall polypropylene (PP) pipes systems incorporate a unique new design for fast, secure assembly. Each connector mouth is contoured in two stages to guide and grip the pipe as it is inserted at substantially reduced insertion forces. A uniquely designed ring seal completes the tight interference fit.

The pipe has a minimum stiffness rating of SN 8 and is manufactured by a co-extrusion process. The outer wall is corrugated, while the inner surface is smooth to ensure excellent hydraulic performance.



Relevant product standards	Selection of certificates
EN 13476 -1, -3	Benor MPA KIWA Insta-Cert

Table 2: Standards & Certificates Wavin X-Stream.



# Wavin X-Stream Product range

ID-based; detailed dimensions available on request

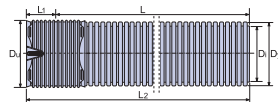

Export length: 5.8 m

Note: excl. seal

## Wavin X-Stream sewer pipe (SN 8)

Dimensions	Effective length (m)	Article code
100		on request
150		on request
200	5.6	3011386018
250	5.6	3011426018
300	5.6	3011456018
400	5.5	3011506018
450	5.5	3011526018
500	5.5	3011606018
600	5.3	3011666018
800	5.2	3011806018

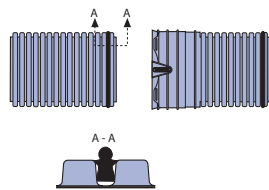

## Wavin X-Stream seal

Dimensions	Article code
100	3290010100
150	3290010160
200	3290010200
250	3290010250
300	3290010300
400	3290010400
450	3290010440
500	3290010500
600	3290010600
800*	3290010800

\* seal for DN/ID 800 has no symetric shape

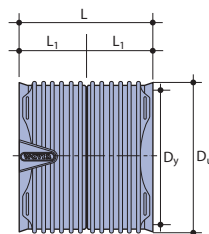

## Wavin X-Stream double-socket coupler

Dimensions	Article code
100	3012572030
150	3012320107
200	3012380107
250	3012420107
300	3012450107
400	3012500107
450	3012520107
500	3012600107
600	3012660107
800*	3012800107

\* fabricated

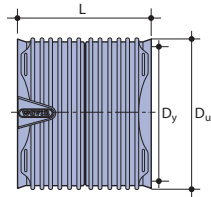

### Wavin X-Stream repair coupler

#### Dimensions

#### Article code

100	3012572040
150	3012320207
200	3012380207
250	3012420207
300	3012450207
400	3012500207
450	3012520207
500	3012600207
600	3012660207
800*	3012800207

\* fabricated

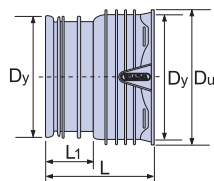

#### Dimensions

#### Article code

100	3012571210
150*	3012320701
200*	3012320702
250*	3012320703
300	3012450307
400*	3012320347
500*	3012320357
600*	3012320367

\* fabricated

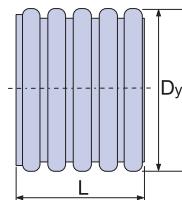

### Wavin X-Stream plug

#### Dimensions

#### Article code

150*	3012320711
200*	3012320712
250*	3012320713
400*	3012500307
450*	3012520307
500*	3012600307
600*	3012660307
800*	3012800307

\* fabricated



**Wavin X-Stream 15° bend**



\* fabricated

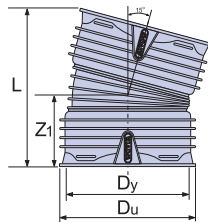

**Dimensions**

- 100
- 150
- 200
- 250\*
- 300
- 400\*
- 450\*
- 500\*
- 600\*

**Article code**

- 3012571011
- 3012320427
- 3012380427
- 3012420427
- 3012450427
- 3012500427
- 3012520417
- 3012600417
- 3012660417



\* fabricated

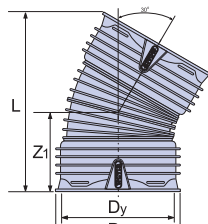

**Wavin X-Stream 30° bend**

**Dimensions**

- 100
- 150
- 200
- 250\*
- 300\*
- 400\*
- 450\*
- 500\*
- 600\*

**Article code**

- 3012571012
- 3012320437
- 3012380437
- 3012420437
- 3012450439
- 3012500437
- 3012520437
- 3012600437
- 3012660437



\* fabricated

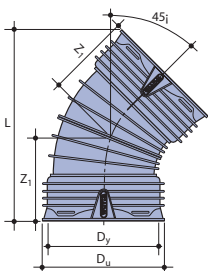

**Wavin X-Stream 45° bend**

**Dimensions**

- 100
- 150
- 200
- 250
- 300
- 400\*
- 450\*
- 500\*
- 600\*

**Article code**

- 3012571013
- 3012320447
- 3012380447
- 3012420447
- 3012450447
- 3012500447
- 3012520447
- 3012600447
- 3012660447

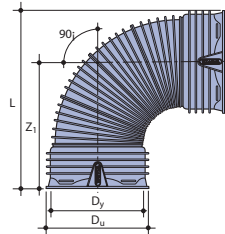

\* fabricated

### Wavin X-Stream 90° bend

#### Dimensions

- 100
- 150\*
- 200
- 250\*
- 300\*
- 400\*
- 450\*
- 500\*
- 600\*

#### Article code

- 3012571014
- 3012320499
- 3012380497
- 3012420497
- 3012450459
- 3012500497
- 3012520497
- 3012600497
- 3012660497

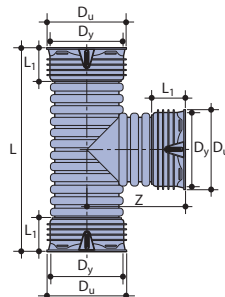

\* fabricated

### Wavin X-Stream 90° T-branch

#### Dimensions

- 150\*
- 200\*

#### Article code

- 3012320559
- 3012380559

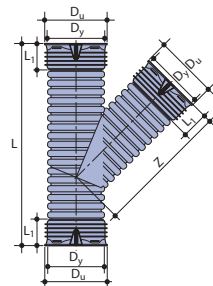

\* fabricated

### Wavin X-Stream 45° Y-branch

#### Dimensions

- 100
- 150
- 200
- 250\*

#### Article code

- 3012571051
- 3012320547
- 3012380547
- 3012420547

**Wavin X-Stream 90° reducing T-branch**

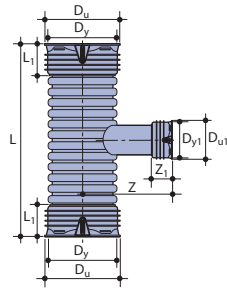
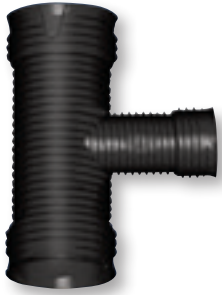

**Dimensions**

**Article code**

250/150*	3017428117
250/200*	3012428216
300/150*	3017458215
300/200*	3017500545
400/150*	3017508125
400/200*	3017508227
400/250*	3017508315
400/300*	3017508427
450/150*	3017600545
450/200*	3017528217
450/300*	3017528317
450/400*	3017528417
500/150*	3017608125
500/200*	3017608217
500/250*	3017608317
500/300*	3017608627
500/400*	3017608617
600/150*	3017668125
600/200*	3017668217
600/250*	3017668317
600/300*	3017668417
600/400*	3017668625
600/500*	3017668725
800/150*	3017808117
800/200*	3017808217
800/250*	3017808317
800/300*	3017808417
800/400*	3017808517
800/500*	3017808717
800/600*	3017808817

\* fabricated

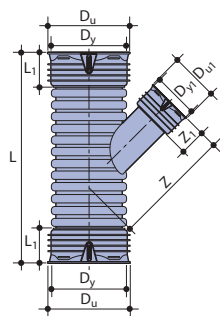

\* fabricated

### Wavin X-Stream 45° reducing Y-branch

#### Dimensions

Dimensions	Article code
200/150*	3012388129
250/200*	3012428227
300/150*	3012458129
300/200*	3012458229
400/150*	3017508215
400/200*	3017508327
400/250*	3017508417
450/150*	3017600547
450/200*	3017528227
450/250*	3017528327
500/150*	3017608125
500/200*	3017608327
500/250*	3017608517
600/150*	3017668225
600/200*	3017668325
600/250*	3017668425
800/150*	3017808127
800/200*	3017808227
800/250*	3017808327
800/600*	3117808927

to be introduced

### Wavin X-Stream PVC 90° reducing T-branch

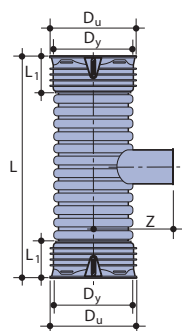

\* fabricated

#### Dimensions

Dimensions	Article code
400/160*	3017501117
400/200*	3017501217
500/160*	3017602117
500/200*	3001115690
600/160*	3017662317
600/200*	3012660585
800/160*	3017802117
800/200*	3017802315



\* fabricated

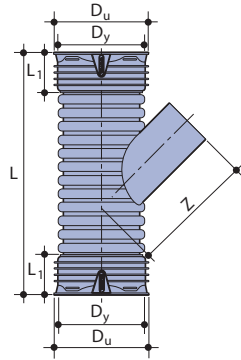

**Wavin X-Stream PVC 45° reducing Y-branch**

**Dimensions**

- 150/110
- 300/160\*
- 400/160\*
- 400/200\*
- 500/160\*
- 500/200\*
- 600/160\*
- 600/200\*
- 800/160\*
- 800/200\*

**Article code**

- 3012320577
- 3012450587
- 3017508115
- 3017502117
- 3017608115
- 3017603217
- 3017668115
- 3017663217
- 3017663317
- 3017663417

- 500/160 Wafix
- 600/160 Wafix

- 3017809157
- 3017809177

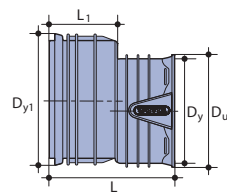

Double Socket

**Wavin X-Stream reducer**

**Dimensions**

- 150/100
- 200/100\*
- 200/150
- 250/100\*
- 250/150\*
- 250/200\*
- 300/150
- 300/200
- 300/250

**Article code**

- 3012320877
- 3012380613
- 3012380617
- 3012400613
- 3012420618
- 3012420622
- 3012450617
- 3012450621
- 3012450627

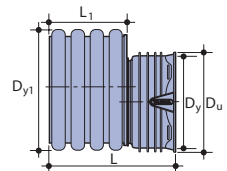

Single Socket

- 400/200\*
- 400/250\*
- 400/300\*
- 500/200\*
- 500/250\*
- 500/300\*
- 500/400\*
- 500/450\*
- 600/250\*
- 600/300\*
- 600/400\*
- 600/500\*
- 800/600\*

- 3012500621
- 3012500627
- 3012500631
- 3012600621
- 3017809187
- 3012600631
- 3012600641
- 3012520607
- 3012660627
- 3012660631
- 3012660641
- 3012660607
- 3012800661

\* fabricated

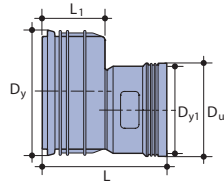

### Wavin X-Stream PVC reducer

#### Dimensions

#### Article code

150/110*	3012320977
200/110*	3012380977
200/160	3012380987
250/160*	3012420988
300/160*	3012450987

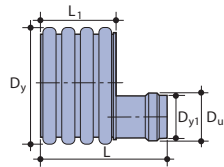

400/160*	3012500987
400/315*	3012500997
500/160*	3012520987
500/315*	3012520997
600/160*	3012660987
600/315*	3012660997

\* fabricated

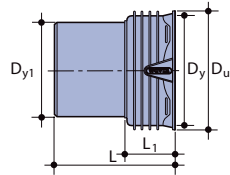

X-Stream pipe - smooth PVC socket

#### Dimensions

#### Article code

100/110	3012571250
200/200	3012380117
250/250	3012420127
300/315	3012450197
400/400*	3012500137
500/500*	3012520157
600/630*	3017906317

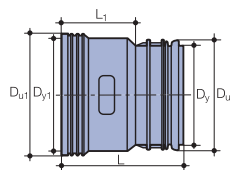

X-Stream socket - smooth PVC pipe

150/160

3012320187

\* fabricated



### Wavin X-Stream PVC connector adaptor

#### Dimensions

#### Article code

150/160*	3012320177
200/200*	3012320197
300/315*	3012320637
400/400*	3012320647

\* fabricated

**Wavin X-Stream protection sleeve**

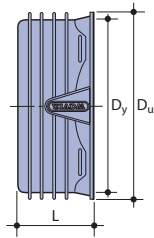

**Dimensions**

Dimensions	Article code
150	3012321907
200	3012381907
250	3012421907
300	3012451907
400	3012501907
450	3012521907
500	3012601907
600	3012661907
800	3012801907

**Wavin X-Stream click inlet**

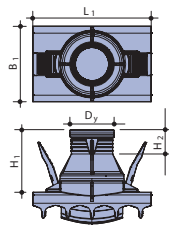
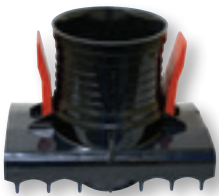

**Dimensions**

Dimensions	Article code
250/150	3212652515
300/150	3212653015
400/150	3212654015
600/150*	3212656018
800/150	3212658015

\* for pipes with ridge spacing equal to 86.6 mm

**Wavin X-Stream click inlet for SW pipe connection**

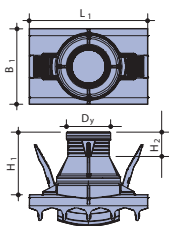

**Dimensions**

Dimensions	Article code
250/160	3212652516
300/160	3212653016
400/160	3212654016
500/160	3212655016
600/160*	3212656017
800/160	3212658016

\* for pipes with ridge spacing equal to 86.6 mm

**Saw (177 mm)**



**Dimensions**

Dimensions	Article code
160	3264945150

# 3. Chambers & manholes

## Product ranges

Wavin inspection chambers and manholes are made of plastic materials and supplement our plastics pipeline systems. They are used for inspecting drainage and sewer networks from the surface level (inspection chambers) and to provide the access for maintenance activities (manholes).

The products are typically also applied in case of junctions and flow diversions or as backdrop chambers. When developing Wavin chambers all the characteristic loads, both static and dynamic, have been taken into consideration. The seasonal variations of the soil and water conditions have been taken into account also.

They are easy to install, fully resistant to external loads and reduce operational problems to a minimum by providing optimal flow conditions. The modular concept is generally considered as most practical, particularly in handling.

Wavin manholes and chambers are applied both in residential and in municipal applications. The main split in application is shown below:

- ⦿ For drainage / residential applications:  
Wavin IC chambers
- ⦿ For sewerage / municipal applications:  
Wavin Tegra chambers / manholes



Figure 2: Wavin plastic system components.

However, the above split is not strict. Depending on local conditions, requirements and conditions, chambers from one group can be used in the other applications as well.

The Wavin IC chambers are available in shaft sizes 315 mm, 400 mm\* and 450 mm.

The Wavin Tegra chambers are available in shaft sizes 425 mm, 600 mm and 1000 mm

The chambers/manholes can be installed in a wide range of conditions: in various types of soil and installation depths (see figure 3), and in areas loaded with heavy traffic.

Most chambers / manholes have been specifically designed to handle external loads:

- ⦿ corrugated shaft pipe\*
- ⦿ ribbed surface structure of base and cone
- ⦿ floating covers
- ⦿ flexible sockets for sewer pipe connectors
- ⦿ double bottom

\*) all shafts are corrugated with and dimensioned on internal diameter, except the IC 400 using smooth wall pipe with 400 mm outside diameter.

The ability to cut the shaft pipe allows the customer to install chambers at various depths. "In-situ" connectors enable assembly of additional pipes. Wavin inspection chambers are the only chambers available in the market which fulfill the hydraulic requirements as specified by the Danish standard DS 2379.



Due to their plastic construction Wavin inspection chambers and manholes have many advantageous features, such as:

- resistance to aggressive media contained in sewage and contaminated ground and vapours
- low weight, enabling installation works without the need to use heavy construction machinery
- resistance to corrosion and freezing
- quick installation and lower risk during installation
- perfect hydraulic properties

Each raw material batch and each product undergoes very strict quality control (at every production stage) to make sure that products sold on the market are defect-free and guarantees trouble-free operation for many years.

### 3.1. Wavin IC range

For the smaller sizes drains and sewers Wavin offers three types of inspection chambers:

- IC 315
- IC 400
- IC 450

With all three types, the base units are injection moulded PP. For the IC 400 any smooth walled PVC or PP pipe with an external diameter of 400 mm can be applied as shaft. For the other two a corrugated PP shaft is required.

Application	Name	Shaft			Sewer pipe range (mm)	Base types	Max. depth	
		type	ins.diam. (mm)	outs.diam. (mm)			chamber (m)	groundw. (m)
Drainage (residential)	<b>IC 315</b>	corr. PP	318	354	110 - 200	I <sub>180</sub> , Y	3	2
	<b>IC 400</b>	PP/PVC		400	110 - 200	I <sub>180</sub> , Y	3	2
	<b>IC 450</b>	corr. PP	450	515	110 - 160	I <sub>180</sub> , L, R, XY	3	2
Sewerage (municipal)	<b>Tegra 425</b>	corr. PP	425	476	110 - 200	I <sub>180</sub> , 150, 120, 90, T, X	10	5
	<b>Tegra 600</b>	corr. PP	600	670	160 - 400	I <sub>180</sub> , 150, 120, 90, T, X	10	5
	<b>Tegra 1000</b>	corr. PP	1000	1100	160 - 500	I <sub>180</sub> , 150, 120, 90, T, Y, X	10	5

Figure 3: Overview Wavin Chambers and Manholes.

Type tests and batch control tests are carried out as per the requirements of the European standard for manholes and non-entry inspection chambers (EN 13598-2). Positive results ensure high quality of plastic chambers and manholes and guarantee their durability and technical parameters adequate for static and dynamic loads occurring on-site.

All plastic components of sewage chambers and manholes are manufactured using state-of-the-art technologies of plastics processing. Individual components are manufactured by moulding and extrusion.

Relevant product standards	Selection of certificates
EN 13598 -1, -2, -3 EN 124 DS 2379	DiBT IBDiM Insta-Cert KIWA

Table 3: Standards & Certificates Wavin IC chambers.

# Wavin IC 315

## 3.1.1 Wavin IC 315

The IC 315 inspection chamber enables inspection, cleaning and maintenance via a shaft of only 315 mm inside diameter. Nevertheless the base units provide proper flow, also where flows from different locations are joined. The IC 315 is available for drains of 110, 160 and 200 mm.



## Wavin IC 315 base configurations

	TYPE I	TYPE Y	TYPE X
	180°	45° junction	90° junction
DN 110			
DN 160			
DN 200			 side inlets DN 160

Figure 4: Wavin IC 315 base configurations.

# Wavin IC 315 Product range

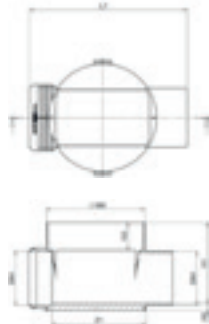

**Wavin IC 315 – Inspection chamber base  
- straight – I type including rubber ring**

Dimensions	DN1	L1	Z1	H1	H2	Article code
110	110	467	348	212	25	3064715001
160	160	505	350	264	25	3064715002
200	200	534	349	301	24	3064715003

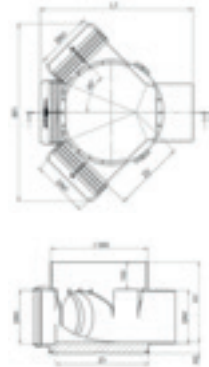

**Wavin IC 315 – Inspection chamber base  
- double junction 45° – Y type including rubber ring**

Dimensions	DN1	L1	Z1	Z2	H1	H2	W1	Article code
DN 110	110	467	348	222	212	32	475	3064715004
DN 160	160	505	350	224	264	25	538	3064715005
DN 200	200	534	349	248	301	41	619	3064715006

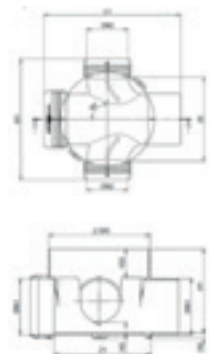

**Wavin IC 315 – Inspection chamber base  
- double junction 90° – X type including rubber ring**

Dimensions	DN1	DN2	L1	Z1	Z2	H1	H2	H3	W1	Article code
DN 200	200	160	534	349	327	301	20	59	472	3064715007

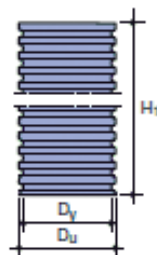

**Wavin IC 315 – Shaft pipe**

Length (H1) mm	Article code
1250	3064114610
2000	3064114620
3000	3064114630
6000	3064114660

# Wavin IC 400

## 3.1.2. Wavin IC 400

The IC 400 inspection chamber is Wavin's solution to provide easy access for inspection, cleaning and maintenance. The product range also allows two or more flows coming together. The IC 400 is available for drains of 110, 160 and 200 mm.

Note: As shaft, also locally produced PP or PVC pipes with OD 400 mm can be applied.



## Wavin IC 400 base configurations

	TYPE I	TYPE Y
	180°	45° junction
DN 110		
DN 160		
DN 200		

Figure 5: Wavin IC 400 base configurations.

# Wavin IC 400 Product range

## Wavin IC 400 - Inspection chamber base straight - I type

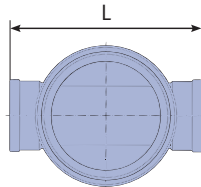

Dimensions	L	Article code
110	514	3011411
160	562	3011412
200	578	3011413

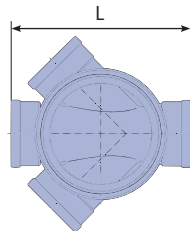

## Wavin IC 400 - Inspection chamber base double junction - Y type

Dimensions	L	Article code
110	514	3011414
160	562	3011415
200	578	3011416

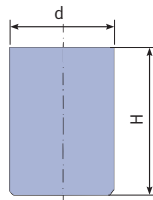

## Wavin IC 400 - Shaft pipe

Length (H)	Article code
500	3010698
800	3020239
1000	3009627
1250	3009634
1500	3009628
2000	3009629

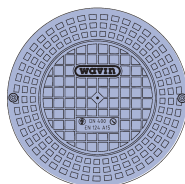

## Cover DN 400 - PP

Type	D	Article code
A15	430	3014470

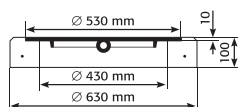
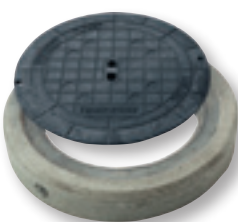

## Combined cover (concrete and cast-iron)

Type	Article code
B125	4023926

# Wavin IC 450

## 3.1.3. Wavin IC 450

The IC 450 inspection chamber enables inspection, cleaning and maintenance with a shaft of 450 mm inside diameter. Compliant with the UK 'Building Regulations' and 'Sewers for adoption' SfA7. The IC 450 is available for drains of 110 and 160 mm.



## Wavin IC 450 base configurations

	TYPE I	TYPE L	TYPE R	TYPE XY
	180°	45 / 90° junction		45 / 90° double junction
DN 110				
DN 160				

Figure 6: Wavin IC 450 base configurations.

# Wavin IC 450 Product range

## Wavin IC 450 – Inspection chamber base straight junction – Type I

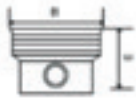

Dimensions	A	B	C	D	E	Article code
110	614	571	500	110	501	44NE300
160	644	570	500	160	501	46NE300

## Wavin IC 450 – Inspection chamber base with straight chan- nel and two branches Left

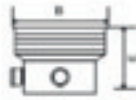
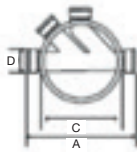

Dimensions	A	B	C	D	E	Article code
110	614	571	500	110	501	44NE304
160	644	570	500	160	501	46NE307

## Wavin IC 450 – Inspection chamber base with straight chan- nel and two branches Right

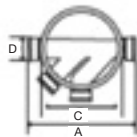

Dimensions	A	B	C	D	E	Article code
110	614	571	500	110	501	44NE305
160	644	570	500	160	501	46NE308

## Wavin IC 450 – Inspection chamber base with straight chan- nel and four branches, two Left and two Right

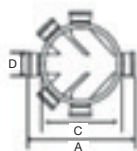

Dimensions	A	B	C	D	E	Article code
110	614	571	500	110	501	44NE306
160	644	570	500	160	501	46NE309

**Note:** The Wavin IC 450 is also available for use with clay pipe work (info available on request).



**Wavin IC 450 – Inspection chamber shaft (PE)**

Dimensions	A	B	Article code
	450	515 3000	40NE300

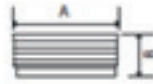

**Wavin IC 450 – Inspection chamber restriction access cap**

Dimensions	A	B	Article code
	450	577 265	40NE930



# Wavin Tegra range

## 3.2 Wavin Tegra range

The Wavin Tegra range of inspection chambers and manholes provides a more sophisticated solution for access, optimal flow performance and flexible inlets, allowing adjustable connections with  $\pm 7.5^\circ$  in each plane, providing ideal installation flexibility.

Relevant product standards	Selection of certificates
EN 13598 -2, -3	DiBT
EN 124	IBDiM
DS 2379	Insta-Cert
	CSTB
	KIWA

Table 4: Standards & Certificates Wavin Tegra range.



# Wavin Tegra 425 base configurations

## 3.2.1 Wavin Tegra 425

The base units are available in 16 different flow profile configurations and the shaft allows in-situ connection in DN110 and DN160:











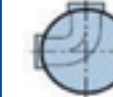

	TYPE I				TYPE T	TYPE X
	180°	150° bend	120° bend	90° bend	90° junction	90° d.junction
DN 110						
DN 160						
DN 200						
DN 250						
DN 315						

Figure 7: Wavin Tegra 425 base configurations.

# Wavin Tegra 425 Product range

## Inspection chamber base for Wavin KG (PVC-U)

### Straight - type I

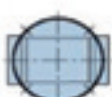
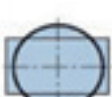
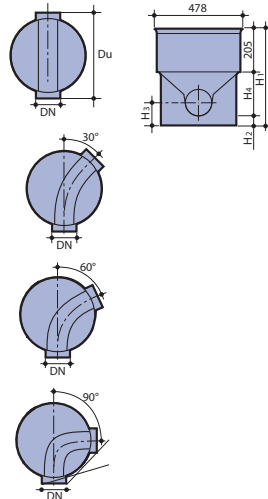

DN mm	Angle °	Du mm	H1 mm	H2 mm	H3 mm	H4 mm	Article code
110	180	538	582	81	111	296	3011327000
160	180	570	611	85	115	320	3011328000
200	180	619	638	93	123	340	3011330000
250	180	909	611	80		326	3011333000
315	180	1005	668	79		383	3011336000
160	150	570	611	85	115	320	3011339000
200	150	619	638	93	123	340	3011341000
160	120	570	611	85	115	320	3011344000
200	120	619	638	93	123	340	3011346000
160	90	570	611	85	115	320	3011349000
200	90	619	638	93	123	340	3011351000

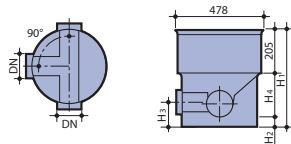

### Junction (left or right inlet) – type T

DN mm	Du mm	H1 mm	H2 mm	H3 mm	H4 mm	Article code
160	570	611	85	115	320	3011354000
200	619	638	93	123	340	3011356000

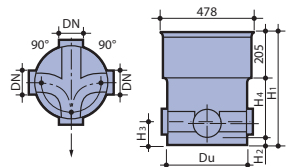

### Double junction (left and right inlet) – type X

DN mm	Du mm	H1 mm	H2 mm	H3 mm	H4 mm	Article code
110	538	582	81	111	296	3011359000
160	570	611	85	115	320	3011360000
200	619	638	93	123	340	3011362000

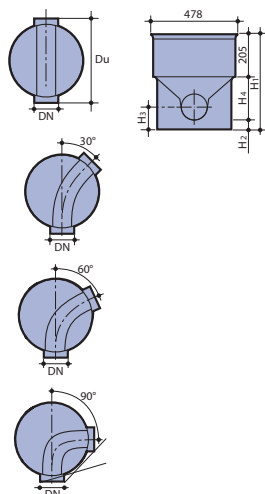

**Inspection chamber base  
for Wavin X-Stream piping – XS connector pipes**

**Straight - type I**

DN mm	Angle °	Du mm	H1 mm	H2 mm	H3 mm	H4 mm	Article code
150	180	627	611	80	110	326	3011329000
200	180	651	638	80	110	353	3011331000
250	180	925	611	65		341	3011334000
300	180	991	668	68		395	3011337000
150	150	627	611	80	110	326	3011340000
200	150	651	638	80	110	353	3011342000
150	120	627	611	80	110	326	3011345000
200	120	651	638	80	110	353	3011347000
150	90	627	611	80	110	326	3011350000
200	90	651	638	80	110	353	3011352000

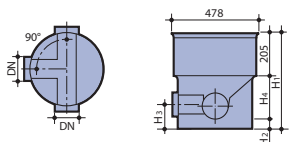

**Junction (left or right inlet) – type T**

DN mm	Du mm	H1 mm	H2 mm	H3 mm	H4 mm	Article code
150	627	611	80	110	326	3011355000
200	651	638	80	110	353	3011357000

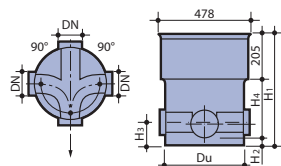

**Double junction (left or right inlet) – type X**

DN mm	Du mm	H1 mm	H2 mm	H3 mm	H4 mm	Article code
150	627	611	80	110	326	3011361000
200	651	638	80	110	353	3011363000

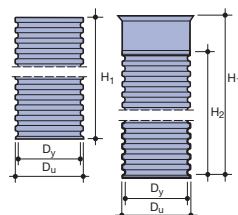

**425 PP corrugated shaft pipe – SN4**

Dimension Dy/H1 mm	Dy mm	Du mm	H1 mm	H2 mm	Article code
425 x 2000	425	476	2000		3011409000
425 x 3000	425	476	3000		3011408000
425 x 6000	425	476	6000		3011407000
425 x 3000*	425	476	3000		3011404000
425 x 6110*	425	476	6166	6016	on request

\*with a socket

**Double socket with two seals for corrugated pipes**

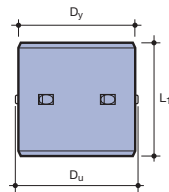

Dimension	Dy	Du	L1	Article code
Dy mm	mm	mm	mm	
425	425	488	410	3264652700

**Pipe sealing ring for corrugated and telescopic pipes**

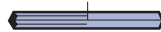

Dimension	Article code
Dy mm	
425	3290954625

**Bottom for corrugated shaft pipe without sealing**

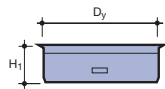

Dimension	Dy	H1	Article code
Dy mm	mm	mm	
425	425	140	3264513585

**“In-situ” connector**

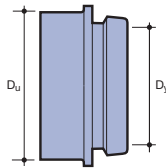

Dimension	Du	Article code
Dy mm	mm	
110	127	3064822401
160	177	3064823401

**Drill saw for drilling openings for “In-situ” connector, universal for PE, PP and PVC**

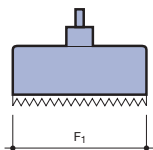

Dimension	F1	Article code
Dy mm	mm	
110	127	3264945120
160	177	3264945150

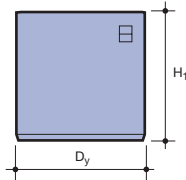

#### Telescopic pipe with seal for corrugated pipes

Dimension	Dy	H1	Article code
Dy mm	mm	mm	
425/375	425	375	3064475106
425/750	425	750	3064475107

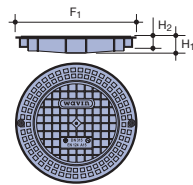

#### PP cover of A14 class for corrugated pipe

Dimension	F1	H1	H2	Article code
	mm	mm	mm	
425	510	46	45	3264127869

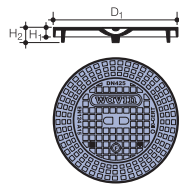

#### Cast-iron cover A15 with 2 bolts to be used with corrugated pipe

Dimension	D1	H1	H2	Weight	Article code
	mm	mm	mm	kg	
425	493	36	59	19	3164144700

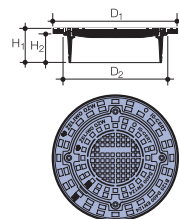
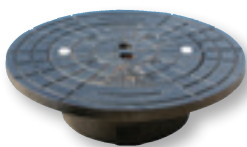

#### B125 cast-iron cover for telescopic pipe – 2 screws

Dimension	D1	D2	H1	H2	Weight	Article code
	mm	mm	mm	mm	kg	
425	532	441	145	117	42	3164142657

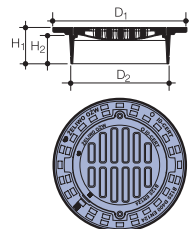

#### B125/425 cast-iron round cover for telescopic pipe – 2 screws

Dimension	D1	D2	H1	H2	Weight	Article code
	mm	mm	mm	mm	kg	
425	532	404	145	117	42	3164142675

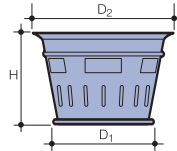

**Sludge basket for grating, A type, galvanized steel**

D1 mm	D2 mm	H mm	Mat.	Weight kg	Article code
270	384	265	galv. steel	5	3164680022

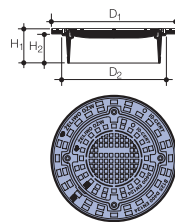
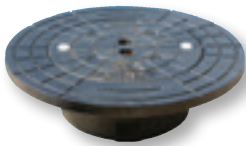

**D400 cast-iron cover  
for 425 telescopic pipe – 2 screws**

Dimension	D1 mm	D2 mm	H1 mm	H2 mm	Weight kg	Article code
425	532	441	145	117	53,6	316414259

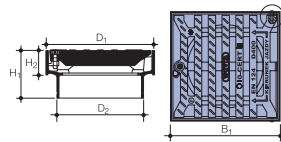

**D400\* cast-iron road grating**

Dimension	D1xB1 mm	D2 mm	H1 mm	H2 mm	Weight kg	Article code
425	500 x 500	404	222	115	86	3164144705

\* option for installing a sludge basket under this grate  
 $F_{WL} = 9 \text{ dm}^2$   
 groove width: 31 mm

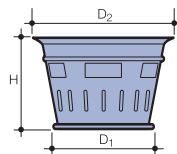

**Sludge basket, B type, galvanized steel**

D2 mm	D1 mm	H mm	Mat.	Article code
385	270	250	galv. steel	3164680020

# Wavin Tegra 600

## 3.2.2 Wavin Tegra 600

Tegra 600 is the universally applicable inspection chamber which avoids time-consuming installation of space-consuming, expensive, traditional manholes.

Like the Tegra 425 it is provided with a fully optimized base unit with flexible pipe inlets and a sculptured top socket for the corrugated shaft. The flexible inlets allow adjustable connection with  $\pm 7.5^\circ$  in each plane, providing ideal installation flexibility.





# Wavin Tegra 600 base configurations

The base units are available in 29 different flow profile configurations and the shaft allows in-situ connection in DN110 and DN160:





























	TYPE I				TYPE T	TYPE X	End base
	180°	150°	120°	90°	90° junction	90° d. junction	
DN 160							
DN 200							
DN 250							
DN 315							
DN 400							
Empty Base							

Figure 8: Wavin Tegra 600 base configurations.

# Wavin Tegra 600

## Product range

### Inspection chamber base\*

#### for Wavin KG (PVC-U) sewer system – SW sockets

\* Within the connectors range of 160-315 adjustable sockets +/-7,5°.

#### Straight – I type

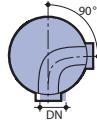
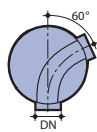
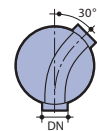
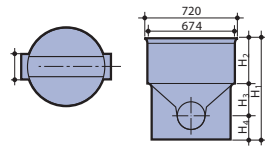

DN mm	Angle °	H1 mm	H2 mm	H3 mm	H4 mm	Weight kg	Article code
160	180	646	207	271	168	21,0	3064634251
200	180	646	207	274	165	22,0	3064638251
250	180	705	207	274	227	23,7	3064642251
315	180	705	207	271	227	25,8	3064646251
400	180	715	207	271	237	26,6	3064650000
160	150	646	207	271	168	21,0	3064634231
200	150	646	207	274	165	22,0	3064638231
250	150	705	207	274	227	23,7	3064642231
315	150	705	207	271	227	25,8	3064646231
160	120	646	207	271	168	21,0	3064634221
200	120	646	207	274	165	22,0	3064638221
250	120	705	207	274	227	23,7	3064642221
315	120	705	207	271	227	25,8	3064646221
160	90	646	207	271	168	21,0	3064634211
200	90	646	207	274	165	22,0	3064638211
250	90	705	207	274	227	23,7	3064642211
315	90	705	207	271	227	25,8	3064646211

#### Junction (left or right inlet) – T type

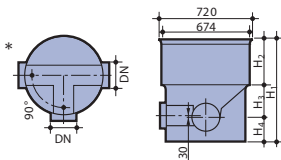

DN mm	H1 mm	H2 mm	H3 mm	H4 mm	Weight kg	Article code
160	646	207	271	168	21,0	3064634311
200	646	207	271	168	23,0	3064638311
250	705	207	271	227	27,5	3064642311
315	705	207	271	227	28,7	3064646311

Side inlet bottom is located 30 mm above the main channel bottom.

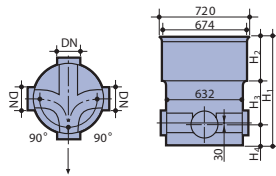

**Double junction (left and right inlet) – X type**

DN mm	H1 mm	H2 mm	H3 mm	H4 mm	Weight kg	Article code
160	646	207	271	168	22,0	3064634411
200	646	207	271	168	24,0	3064638411
250	705	207	271	227	27,5	3064642411
315	705	207	271	227	31,6	3064646411

Side inlet bottom is located 30 mm above the main channel bottom.

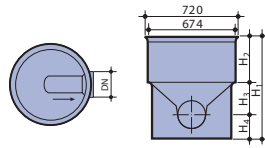

**End base**

DN mm	H1 mm	H2 mm	H3 mm	H4 mm	Weight kg	Article code
200	646	207	271	168	20,0	3064638271
250	705	207	271	227	22,0	3064642271
315	705	207	271	227	23,1	3064646271

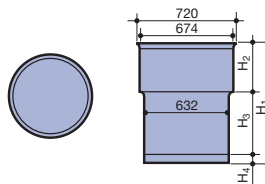

**Empty base (without inlets and outlets)**

DN mm	H1 mm	H2 mm	H3 mm	H4 mm	Weight kg	Article code
-	715	207	451	57	20,0	3064600000

Bases with oil resistant sealing possible to order.

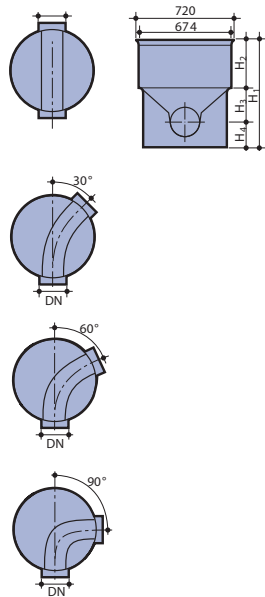

**Inspection chamber base\*  
for Wavin X-Stream – XS connectors**

\* Within the connectors range of 150-300 adjustable sockets +/-7,5°.

**Straight – I type**

DN mm	Angle °	H1 mm	H2 mm	H3 mm	H4 mm	Weight kg	Article code
150	180	646	207	271	168	21,0	3064634252
200	180	646	207	274	165	22,0	3064638252
250	180	705	207	274	227	23,7	3064642255
300	180	705	207	271	227	25,8	3064646255
400	180	715	207	271	237	26,6	3064601001
150	150	646	207	271	168	21,0	3064634232
200	150	646	207	274	165	22,0	3064638232
250	150	705	207	274	227	23,7	3064642235
300	150	705	207	271	227	25,8	3064646235
150	120	646	207	271	168	21,0	3064634222
200	120	646	207	274	165	22,0	3064638222
250	120	705	207	274	227	23,7	3064642225
300	120	705	207	271	227	25,8	3064646225
150	90	646	207	271	168	21,0	3064634212
200	90	646	207	274	165	22,0	3064638212
250	90	705	207	274	227	23,7	3064642215
300	90	705	207	271	227	25,8	3064646215

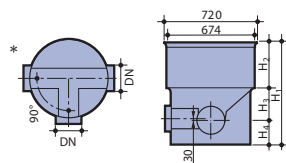

**Junction (left or right inlet) – T type**

DN mm	H1 mm	H2 mm	H3 mm	H4 mm	Weight kg	Article code
150	646	207	271	168	21,0	3064634312
200	646	207	271	168	23,0	3064638312
250	705	207	271	227	27,5	3064642315
300	705	207	271	227	28,7	3064646315

Side inlet bottom is located 30 mm above the main channel bottom.

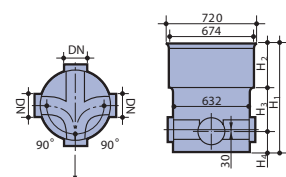

**Double junction (left and right inlet) – X type**

DN mm	H1 mm	H2 mm	H3 mm	H4 mm	Weight kg	Article code
150	646	207	271	168	22,0	3064634412
200	646	207	271	168	24,0	3064638412
250	705	207	271	227	27,5	3064642415
300	705	207	271	227	31,6	3064646415

Side inlet bottom is located 30 mm above the main channel bottom.

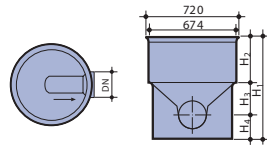

**End base**

DN mm	H1 mm	H2 mm	H3 mm	H4 mm	Weight kg	Article code
200	646	207	271	168	20	3064638272
250	705	207	271	227	22	3064642275
300	705	207	271	227	23,1	3064646275

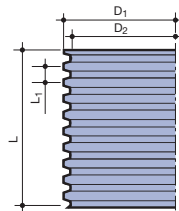

**PP 600 corrugated shaft pipe – SN4**

L mm	D1 mm	D2 mm	L1 mm	Weight kg	Article code
1000	670	600	100	13,1	3064116610
2000	670	600	100	26,2	3264116620
3000	670	600	100	39,3	3264116630
6000	670	600	100	78,6	on request
3650*	670	600	100	49,8	3264116639

\*with a socket

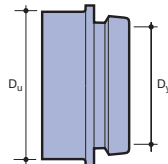

**In-situ insert for Tegra 600 chamber**

Dimension Dy mm	Du mm	Article code
90	127	3064822406
110	127	3064822408
160	177	3064823408
200	228	3064823808

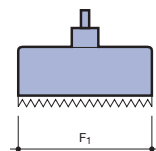

**Drill saw for drilling openings assigned for “In-situ” connector, universal for PE, PP and PVC**

Dimension Dy mm	F1 mm	Article code
110	127	3264945120
160	177	3264945150
200	228	3264650083



### Seals

for DN 600 corrugated shaft pipe

Article code

3290126605



self-lubricating seal for telescopic adapter

Article code

3290695497

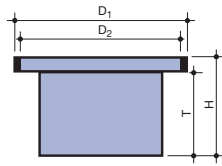

### Telescopic adapter

Type	D1 mm	D2 mm	H1 mm	T	Weight kg	Article code
770*	798	774	462	400	11,0	3264600250
805**	850	805	462	400	12,0	3264600400

\* for covers with base up to Ø 760 mm

\*\* for covers with base larger than Ø 760 mm

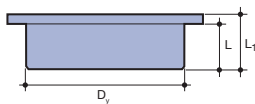

### PE cover A15 class for the corrugated pipe

Type	L mm	L1 mm	Dy mm	Article code
A15 without locking	180	210	600	3264542195
A15 with locking	235	270	600	3264542190

Cover without lock installed by pressing.

Cover with lock equipped with the patented blocking mechanism.

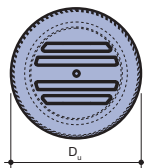

### PE installation cover for the corrugated pipe

Du  
mm

745 3264431610

The cover protects against impurities during installation.

**Cast iron cover with round base**

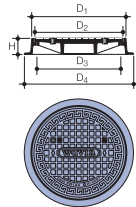
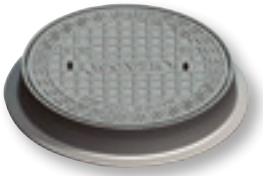

Type	D1 mm	D2 mm	D3 mm	D4 mm	H mm	Weight kg	Article code
A15/600/755	755	663	638	604	80	50	3164804300
B125/600/755	755	663	638	604	80	75	3164804305
D400/600/760	760	666	638	604	115	110	3164804345
A15 cover	-	690	-	-	40	21	3164144740

**Road grating, grey cast iron, 400 x 600, H115, D400, 3/4 flange, hinges/bolts**

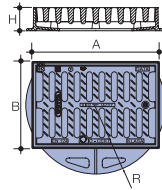

Type	A x B mm	R mm	H mm	Weight kg	Article code
D400	600 x 400	345	115	92	3164204605

$F_{WL} = 9,0 \text{ dm}^2$

**Sludge basket for road grating 400x600 galvanized steel type D**

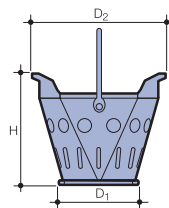
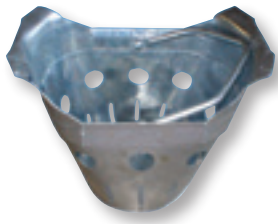

Dimension mm	Material	Article code
400 x 600	galvanized steel	3164680010

# Wavin Tegra 1000 NG

## 3.2.3 Wavin Tegra 1000 NG

In line with EN 476 the Wavin Tegra 1000 is classified as a sewer manhole with a shaft size (inner diameter) of 1,0 m.

The Wavin Tegra 1000 NG manhole range mainly consists of components made of PP fully capable of handling the highest traffic class.

**Note:** The Wavin Tegra 1000 NG manhole has replaced the earlier Tegra 1000 IG manhole, consisting of PE components. This earlier version is still available on request.

Tegra 1000 has a modular structure and consists of three basic elements:

- ▷ base (the manhole basis)
- ▷ shaft, consisting of a corrugated pipe
- ▷ cone which reduces the manhole diameter from 1,0 m to 0,64 m to enable using the cover

Like the Tegra 425 and the Tegra 600 it is provided with a fully optimized base unit with flexible pipe inlets and a sculptured top socket for the corrugated shaft. The flexible inlets allow adjustable connection with +/- 7.5° in each plane, providing ideal installation flexibility.















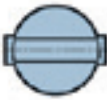











The cover solution is constructed with a reinforced concrete supporting ring and the cover. For access, the manhole may be provided with a (dedicated) ladder, made of corrosion-free GRP (glass reinforced plastic).





# Wavin Tegra 1000 NG base configurations

The PP base units are supplied with flexible inlets for the sewer pipes and with a sculptured top socket to receive the shaft. The shaft consists of an extruded corrugated 1000 mm PP pipe.

	TYPE I				TYPE T*	TYPE Y	TYPE X
	0°	150°	120°	90°	90° junction	45° d. junction	90° d. junction
DN 160							
DN 200							
DN 250							
DN 315**							
DN 400 DN 500	 PE	 PE					

\* : Type T = Type X with plug  
 \*\*: Also with DN 300 X-Stream sockets

Figure 9: Wavin Tegra 1000 NG base configurations.

**Note:** Other base configurations (pipe sizes, flow profiles) available on request.

# Wavin Tegra 1000 NG

## Product range

### Base of Tegra 1000 NG for Wavin KG (PVC-U) - SW sockets

#### Straight - I type

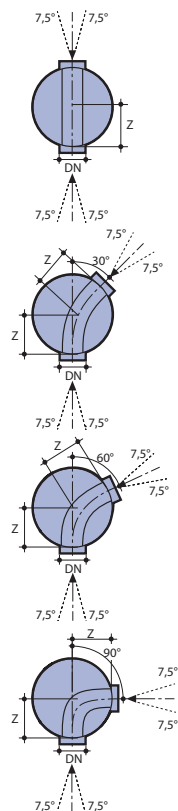
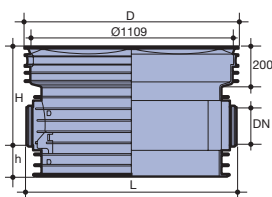

DN	Angle °	D mm	H mm	h mm	L mm	z mm	Mat	Weight kg	Article code
160	180	1187	536	185	1178	512	PP	57	161180
200	180	1187	536	185	1168	486	PP	57	120180
250	180	1187	647	185	1263	509	PP	64	125180
315	180	1187	647	185	1250	477	PP	64	131180
400	180	1194	863	188	1282	432	PE	100	2598041
500	180	1194	867	184	1207	396	PE	104	2598051
<hr/>									
200	150	1187	536	185	-	486	PP	57	120150
250	150	1187	647	185	-	509	PP	64	125150
315	150	1187	647	185	-	477	PP	64	131150
<hr/>									
200	120	1187	514	185	-	486	PP	57	120120
250	120	1187	647	185	-	509	PP	64	125120
315	120	1187	647	185	-	477	PP	64	131120
<hr/>									
160	90	1187	536	185	-	512	PP	57	161090
200	90	1187	536	185	-	486	PP	57	120090
250	90	1187	647	185	-	509	PP	64	125090
315	90	1187	647	185	-	477	PP	64	131090

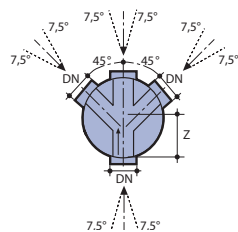

#### Double junction

#### (left and right inlet at the angle of 45°) - Y type

DN	Angle °	D mm	H1 mm	h mm	l mm	z mm	Mat	Weight kg	Article code
160	45	1187	536	185	1178	512	PP	59	161445
200	45	1187	536	185	1168	486	PP	59	120445
250	45	1187	647	185	1263	509	PP	65	125445
315	45	1187	647	185	1250	477	PP	65	131445

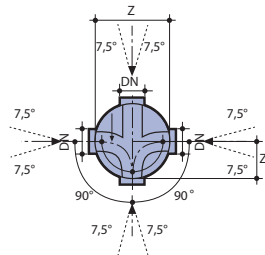

**Double junction**  
**(left and right inlet at the angle of 90°) - X type**

DN	Angle °	D mm	H1 mm	h mm	l mm	z mm	Mat	Weight kg	Article code
160	90	1187	536	185	1178	512	PP	57	161490
200	90	1187	536	185	1168	486	PP	57	120490
250	90	1194	622	185	414	509	PP	64	125490
315	90	1194	622	185	397	474	PP	64	131490

**Base of Tegra 1000 NG**  
**for Wavin X-Stream sewer – XS sockets**

**Straight – I type**

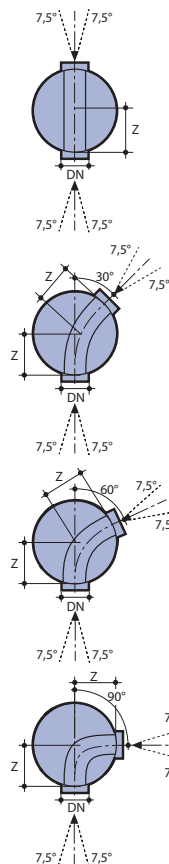
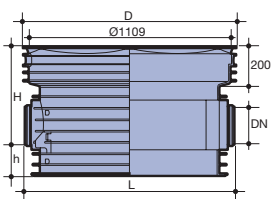

DN	Angle °	D mm	H mm	h mm	Lz mm	Mat	Weight kg	Article code
300	180	1187	647	185	1250 474	PP	64	139180
400	180	1194	863	188	1220 422	PE	100	2598141
500	180	1194	867	184	1207 374	PE	104	2598151
300	150	1194	622	185	397	PP	64	139150
300	120	1194	622	185	397	PP	64	139120
300	90	1194	622	185	397	PP	64	139090

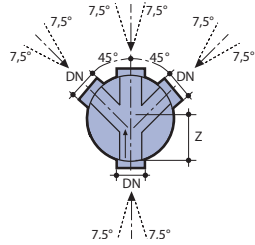

**Double junction  
(left and right inlet at the angle of 45°) – Y type**

DN	Angle °	D mm	H mm	h mm	L mm	z mm	Mat	Weight kg	Article code
300	45	1194	647	185	1250	477	PP	64	139445

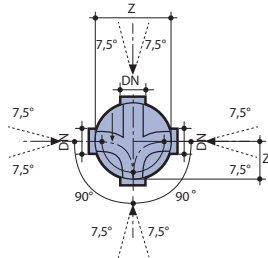

**Double junction  
(left and right inlet at the angle of 90°) - X type**

DN	Angle °	D mm	H mm	h mm	L mm	z mm	Mat	Weight kg	Article code
300	90	1194	647	185	1250	477	PP	64	139490

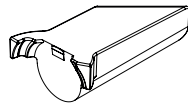

**Inlet plug (45°) - to be used with 45° Y type**

Dimension mm	Article code
200 right	502416
200 left	502417
315 right	on request
315 left	on request



**Inlet plug (90°) - to be used with 90° X type**

Dimension mm	Article code
200 right	502418
200 left	502419
315 right	on request
315 left	on request

To plug off inlets of base units Y- and X-types

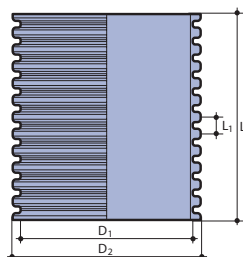

**PP 1000 Corrugated shaft pipe - SN2**

D1 mm	D2 mm	L mm	L1 mm	Weight kg/m	Article code
1004	1108	1200	100	27	3064131012
1004	1108	2400	100	27	3064131024
1004	1108	3600	100	27	3064131036
1004	1108	6000	100	27	on request

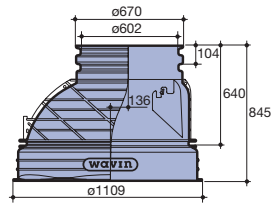

**Cone**

Dimension mm

1000/600

Article code

100700

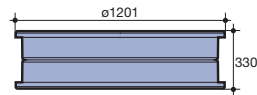

**Double socket for interconnecting shaft pipes**

Dimension mm

1201/330

Article code

3264573300



Shaft seal

**Rubber seal**

for Tegra 1000 NG corrugated shaft pipe

Dimension mm

1000

Article code

3264580100

for cylindrical corrugated part of cone  
for Tegra 1000 NG



Cone seal

Dimension mm

600

Article code

3264572900



**GRP Ladder (set including bracket)**

Length mm	Steps number	Brackets number	Article code
1,63	6	1	3064821106
2,83	10	1	3064821110
4,03	14	2	3064821114
5,23	18	2	3064821118



**Ladder bracket**

Bracket = stripe + 2 string

Article code

3064823901



### In-situ insert

Dimension mm	Dy mm	Du mm	Article code
90	90	127	3064822406
110	110	127	3064822407
160	160	177	3064823407
200	200	228	3264556027

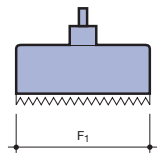

### Drill saw for drilling opening for in-situ connectors

Dimension Dy mm	F1 mm	Article code
110	127	3264945120
160	177	3264945150
200	228	3264650083

One type for PE, PP and PVC

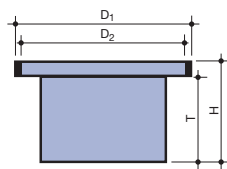

### Telescopic adapter

Type	D1	D2 mm	H mm	T mm	Weight kg	Article code
770*	798	774	462	400	11,0	3264600250
805**	850	805	462	400	12,0	3264600400

\* for covers with base up to Ø 760 mm

\*\* for covers with base bigger than Ø 760 mm

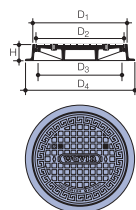
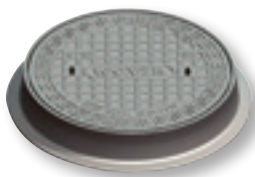

### Cast iron cover with round base

Type	D1 mm	D2 mm	D3 mm	D4 mm	H mm	Weight kg	Article code
A15/600/755	755	663	638	604	80	50	3164804300
B125/600/755	755	663	638	604	80	75	3164804305
D400/600/760	760	666	638	604	115	110	3164804345
A15 cover	-	690	-	-	40	21	3164144740

## 4. Design information & technical data

Generally the pipe line layout is influenced by topography and the calculated discharge from the respective area, taking into account any foreseen developments. It is most economical when the pipe line track follows the existing landscape as much as possible.

Access chambers should be located at places where they can be reached by maintenance workers and equipment. Detailed recommendations on pipeline design are covered by EN 752-3.

### 4.1 Pipe & fittings

#### 4.1.1. General

The SDR is the 'Standard Dimensional Ratio' and refers to the geometry of the pipe. SDR is defined as the ratio of the nominal outside diameter to the nominal wall thickness.

$$SDR = d_n / e_n$$

$d_n$  = the nominal outside diameter of the pipe (m)

$e_n$  = the nominal (minimum) wall thickness of the pipe (m)

For the structural performance in particular, the pipe ring stiffness SN is an important characteristic to take into account.

$$SN = 1/12 \times E / SDR^3$$

SN = ring stiffness of the pipe (kPa)

E = modulus of elasticity of the pipe (kPa)

For the Wavin PVC-U solid wall sewer pipes the relationship is as follows:

SDR	SN
41	> 4 kPa
34	> 8 kPa

For structured wall pipes the stiffness can not be calculated from the wall thickness. The ring stiffness is then measured as defined by EN 13476.

#### 4.1.2. Hydraulic performance

The hydraulic design of the system ensures that the design meets all relevant functional requirements including protection from flooding and maintainability.

#### Flow formulae

The following formulae apply for calculating the flow in completely filled pipelines. The General flow relationship is expressed by:

the Continuity equation:

$$Q = v \cdot \pi/4 \cdot D_i^2$$

where:

Q = flow capacity or discharge (m<sup>3</sup>/s)

v = flow velocity (m/s)

$D_i$  = internal pipe diameter (m)

The fluid characteristics are expressed by:

Reynold's Number:

$$Re = v \cdot D_i / \mu$$

where:

$\mu$  = kinematic viscosity of the fluid (m<sup>2</sup>/s)

The pressure loss (head loss) is given by:

Darcy / Weisbach:

$$i = \lambda \cdot v^2 / (2g \cdot D_i)$$

where:

i = pressure loss per metre (m/m),

or: x 100 (%)

$\lambda$  = friction coefficient (-)

g = gravitational constant (m/s<sup>2</sup>)

The friction coefficient is determined by:  
Colebrook / White:

$$1/\sqrt{\lambda} = -2 \log \left[ \frac{2.51}{\text{Re}\sqrt{\lambda}} + \frac{(k/D_i)}{3.71} \right]$$

where:

$k$  = pipe wall roughness (m)

$k/D_i$  = relative roughness (-)

The  $k$ -value is material- and application dependent.

For pressure water supply applications, the  $k$ -values vary from 0.01 mm for thermoplastic pipe to 5.0 mm for extremely corroded steel pipe.

For non-pressure sewer applications, the same values as for pressure applications would apply, e.g. 0.01 mm for thermoplastic pipe. However, next to sedimentation, also the directional changes and junctions in (open flow channel) inspection chambers and the frequently present lateral connections play a major role on flow performance, in particular at relatively low flow velocities. All these extra friction components can be calculated individually, but it is more common to use a so-called 'operational roughness'-value. The term 'operational roughness' was firstly introduced by the German Sewer authority ATV (Abwasser Technische Vereinigung): 'betriebliche Rauigkeit'  $k_b$ .

In the latest version of their regulation, officially in Germany adopted, the values as presented in Table 1 are included.

Sewer type & condition	$k_b$ [mm]
straight sections/ no shafts	0.25
transport sewers + shafts	0.50
collector sewers + shafts	0.75
collectors with rough bore + shafts	1.50

Table 5: Operational pipe wall roughness ( $k_b$ ) of pipelines acc. to ATV A110.

As a next step the effect of partial filling can be analysed. For this, reference is made to Bretting's formula:

$$Q_p/Q = 0.46 - (\cos \pi f) / 2 + (\cos 2 \pi f) / 25$$

with:

$Q_p/Q$  = relative flow discharge

$f$  = filling rate

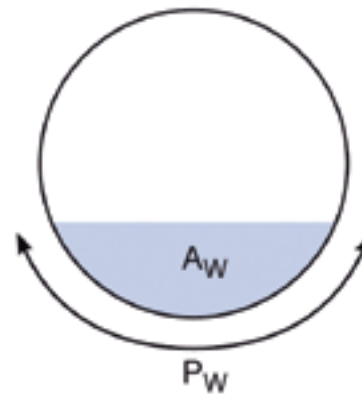

Figure 10: Partial filling.

**Note 1:** Cos independent variables have been given in radians; to change the values into degrees  $\pi$  shall be replaced by  $180^\circ$ .

**Note 2:** This formula takes into account the air turbulence (resistance) above water at near filling.

The effect from the less amount of flow quantity on the flow velocity can be derived by using equation:

$$Q_p = v \cdot \pi/4 \cdot D_H^2$$

with:

$D_H$  = hydraulic diameter

defined as:

$$D_H = 4 \cdot A_W / P_W$$

with:

$A_W$  = wetted area (m)

$P_W$  = wetted perimeter (m)



### 4.1.3. Structural performance

With non-pressure pipe (sewer) applications, the main design criteria are related to allowable deflection and safety against buckling: pipe-soil interaction design.

#### Deflection

Plastic pipes, when installed with open cut trenches, interact very much with the surrounding soil, particularly in non-pressure applications. The flexible nature of a plastic pipe and the relatively low stiffness (compared to the surrounding soil) results in some deformation, to accommodate to the situation around.

The amount of deformation of a direct-bury plastic pipe is influenced by various factors, such as: soil types and installation quality, depth of cover, ground water level, pipe stiffness, traffic influences etc.

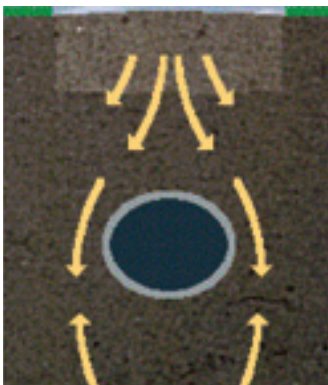

Figure 11: External loading on the pipe soil system.

In 1996 The European Plastics Pipe and Fittings Association (TEPPFA) embarked on a substantial practical research study from a user's perspective, with input of various independent experts, looking at the performance of plastics pipes under various installation conditions. The TEPPFA work focused on only one parameter – pipe deflection.

In the conclusions of the TEPPFA work, the significant contribution of the quality of installation was highlighted.

In the research study the installation qualities were identified as follows:

#### Well:

The embedment soil of a granular type is placed carefully in the haunching zone and compacted, followed by placing the soil in shifts of maximum 30 cm, after which each layer is compacted carefully. A layer of 15 cm of soil shall at least cover the pipe before the trench is further filled with soil of any type and compacted. Typical values of standard proctor are above 94%.

#### Moderate:

The embedment soil of a granular type is placed in batches, a maximum of 50 cm deep, after which each layer is compacted carefully. A layer of 15 cm shall at least cover the pipe before the trench is further filled with soil of any type. Typical values for the proctor density are in the range of 87% to 94%.

#### None:

The embedment soil of any type is added without compaction. However, big dry lumps of clay or rocks with excessive sizes shall not be placed directly on the pipe.

Pipes do not deflect uniform over the whole pipeline section. Along the length of a pipeline, the pipe deflection varies. In case of good or "well" type of deflection, the deflections are low and also the pattern is very regular. Hence, average and maximum deflections are rather close to each other. Pipes that are installed in a poor way, without any care, show higher average deflection as well as higher maximum or peak deflections. In figure 12 this is illustrated.

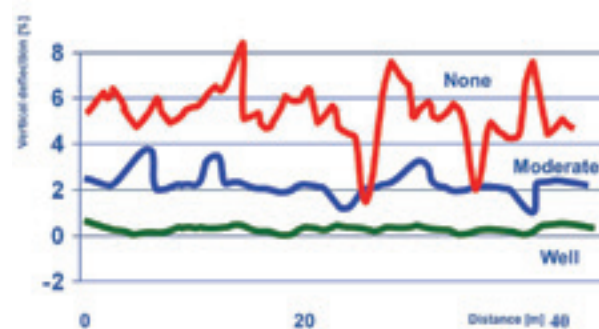
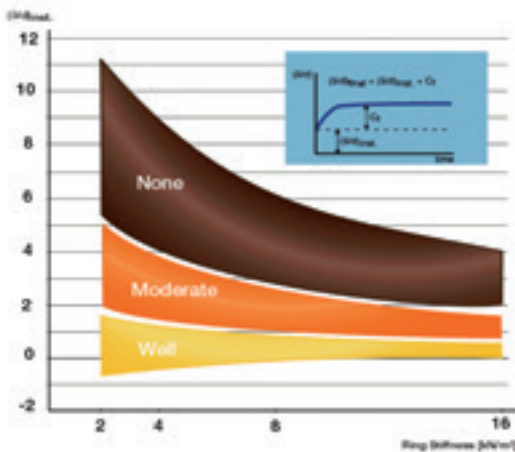

Figure 12: Deflection patterns along the pipeline.

The pipe deflections, average and maximum, in relation to pipe stiffness and quality of installation can be estimated by using Figure 13.



**Note:** The average deflections immediately after installation are represented by the lower boundary of each area, and the maximum values by the upper boundaries.

Figure 13: Pipe deflections in buried pipes.

This figure is at least applicable to situations where:

- ⦿ The burial depth is between 0.8 m and 6 m,
- ⦿ Pipe diameters up to 1100 mm diameter,
- ⦿ Burial depth to diameter ratio is  $\geq 2.0$ .
- ⦿ Sheet piles or trench shields, if used, are removed before compaction. Otherwise the well or moderate compaction will be reduced to the “none” compaction level.
- ⦿ The installation categories “well”, “moderate” and “none” reflect the level of compaction upon which the designer can rely.

Further information about the TEPFFA project is available on their website [www.teppfa.com](http://www.teppfa.com).

## Buckling

The buckling resistance of a buried pipe can be determined by comparing the actual outside sustained pressure against the critical buckling pressure of the pipe. For buried pipes, sustained load is basically the load exerted by groundwater on the pipe.

The groundwater pressure on the pipe can be calculated by:

$$q = 9,81 \times H_g$$

with:

- q = acting ground water pressure (kPa)
- H<sub>g</sub> = depth of groundwater over the pipe (m)

The resistance against buckling can be calculated (for firm soils) as follows:

$$q_{crit} = 5,63 \sqrt{E_t \times SN}$$

with:

- q<sub>crit</sub> = critical buckling pressure (kPa)
- SN = ring stiffness of the pipe (kPa)
- E<sub>t</sub> = tangent modulus of the soil (kPa) (see below)

The E<sub>t</sub> values obviously vary per soil type and rate of compaction (see table 9).

### 4.1.4. Chemical resistance

Plastic pipe systems are ideal for transporting a wide variety of chemicals and are widely used in industries where conveyance of highly corrosive liquids and gases require products with excellent corrosion resistance.

The exceptional resistance of plastics pipes to chemical attack is well known and generally there are no naturally occurring ground conditions which affect the material. Plastics do not corrode, rot, pit or lose their mechanical strength properties through electrical or chemical reactions with backfill soils. The resistance to a wide variety of chemicals in different concentrations is provided by ISO/TR 10358, covering amongst others the corrosion resistance of PVC-U and PP pipe systems, to 427 chemicals of different concentration at different temperatures. In case of any doubt or specific questions, Wavin will be pleased to advice about the suitability.

Soil type		Uncompacted	Compacted & inspected	Compacted, inspected & verified
1	Non-cohesive	1400	4000	10000
2	Slightly cohesive	1200	2400	6000
3	cohesive mixed soils, silt	1000	2000	5000

Table 6: Soil tangent modulus  $E_t$  (kPa).

## 4.2. Chambers & manholes

### 4.2.1. General

Access shall be provided (where practicable) at every:

- ⦿ change of alignment
- ⦿ junction
- ⦿ change in the size of a sewer

In addition access shall be provided at:

- ⦿ reasonable intervals for inspection and maintenance

National or local regulations can specify requirements for the location and spacing of manholes/inspection chambers.

In EN 476 distinction is made between manholes and inspection chambers:

- ⦿ a manhole provides manual access and requires an internal size of 1000 mm
- ⦿ an inspection chamber permits the introduction of cleaning, inspection and test equipment, but does not provide manual access

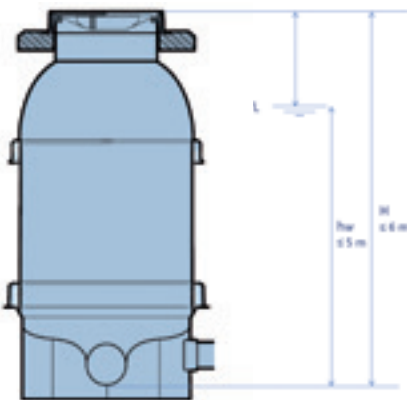

Figure 14.

From a product quality point of view, all components of the Wavin Tegra manhole & inspection range comply with EN 13598-2, ensuring adequate resistance to any site loadings and durability in operation. Amongst others, the structural strength is sufficient to deal with 6 m depth of cover and tightness is ensured to withstand a pressure of at least 0.5 bar or 5 m water column. Regarding chemical resistance, all plastic components comply with ISO/TR 10358 (as the pipes, see 4.1.4), and rubber seals with ISO/TR 7620. Elimination of concrete works keeps the assembly time shorter and assembly costs lower.

### 4.2.2. Base units

The base units of Wavin Tegra manholes and chambers are fully optimized regarding flow characteristics. All base units meet the very strict requirements of the Danish Standard DS 2379, demonstrated by type tests which were performed by the Danish Institute of Technology (DTI).

### 4.2.3. Shafts

The ribbed surface of the Wavin Tegra manholes and chambers, prevents buoyancy and eliminates the use of additional top weight or chamber anchoring, even with high groundwater levels. The installation prescriptions presented in chapter 7 of this manual are sufficient to prevent any displacement of chambers by groundwater.

The Wavin Tegra series all have a corrugated shaft, facilitating the settlement of the soil without resulting in either high loads to the base or resulting in a bad fit between street surface and chamber cover. It is advised to use always the chambers having corrugated shafts when installed to depths more than 2 meters or when installed in poor soils.

The shaft height can be determined as follows:

$$S = H - T - C - B$$

- S = length of shaft
- H = total height of the chamber/manhole  
(= surface <-> bottom invert level pipe) following design
- T = height (net) of the top construction (details in annex 2)
- C = height (net) of the cone
- B = height (net) of the base unit

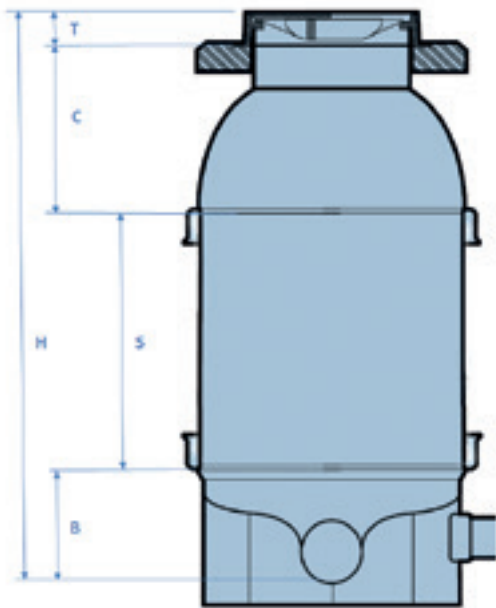

Figure 15.

#### 4.2.4. Manhole steps / ladders

Traditionally manholes were supplied with step irons for manual access. The experience with the use of iron steps however is that after some years they start to suffer from corrosion especially at the iron-concrete interface. Nowadays for safety reasons there is strong international trend to avoid integrated access and the use of loose ladders is stimulated in many countries.

Although not stimulated, Wavin does offer access solutions for the Tegra 1000 manholes. Ladders can be ordered or cut on-site to the required length. Details are presented in Annex 1. The ladder is made of GRP in order to avoid the corrosion problem.

#### 4.2.5. Top constructions

In general, locally fabricated top constructions are applied. Although not stimulated, Wavin also offers top constructions for the Tegra inspection chambers and manholes. Details are presented in Annex 2.

	Pipe size	IC 315	IC 400	IC 450	Tegra 425	Tegra 600	Tegra 1000 NG
Height B (net) of Base unit	Ø 110 mm	0.20 m	0.20 m	0.50 m	0.30 m	-	-
	Ø 160 mm	0.25 m	0.25 m	0.50 m	0.32 m	0.35 m	-
	Ø 200 mm	0.30 m	0.30 m	-	0.34 m	0.37 m	0.34 m
	Ø 250 mm	-	-	-	0.36 m	0.40 m	0.42 m
	Ø 315 mm	-	-	-	0.38 m	0.43 m	0.42 m
	Ø 400 mm	-	-	-	-	0.47 m	0.66 m
	Ø 500 mm	-	-	-	-	-	0.67 m
Height C (net) of Cone		-	-	-	-	-	0.66 m

Table 7: Heights of base units and cones.

# 5. Transport, handling & storage

## 5.1. General

This section contains current guidelines and requirements for the installation of the sewer systems, to fulfill the quality requirements of the pipeline and to secure a constant quality of installation. It includes recommendations for the pipe surround and backfilling procedures but not road base and road sub-base details. Attention is drawn to any national regulations which may cover these or other aspects of installation. It is intended to be used by authorities, design engineers and installers.

Much of the guidance is expressed as requirements, e.g. by use of “shall” or by instructions in the imperative. It is strongly recommended that these be followed whenever applicable. Other guidance is presented for consideration as a matter of judgment in each case, e.g. by use of “should”. To obtain a constant high-quality working standard, a regulated and documented procedure shall be followed.

Process and work instructions are integral components of a quality-secured process execution and are to be followed and documented for all quality relevant jobs during the X-Stream installation process.

During installation, the applicable accident prevention instructions of the unions and labour associations, the traffic regulations and the guidelines for safeguarding work places at roads have to be followed. The contracting companies carrying out the work shall have competent personnel possessing the qualification necessary for executing. A prerequisite for a high-quality and environmentally friendly execution of the installation is a set of equipment, which is technically state-of-the-art and in line with current regulations concerning:

- ▷ Safety
- ▷ Noise protection
- ▷ Protection of air, ground and water

## 5.2. Transport

When transporting pipes, flat-bed vehicles shall be used. The bed shall be free from nails and other metallic protuberances, which may damage the pipes. Secure the pipes effectively before transporting them. Ensure that all side supports, if required, are flat and free from sharp edges.

When loading socket-ended pipes, stack the pipes so that the sockets are not in contact with adjacent pipes. The largest diameter pipes should be placed on the bed of the vehicle. Pipes should preferably not overhang the vehicle, and in any case not by more than five times the diameter or 2 meters, whichever is lesser.

## 5.3. Handling

When handling the pipes, fittings and chambers, take care to prevent damage. Plastics products can be damaged when in contact with sharp objects or if dropped, thrown or dragged along the ground. In all circumstances, do not drop or throw products and pallets. In case of unloading pipes from the trucks with backhoe and crane, lifting belts (e.g. textile belts, etc.) shall be used. Chains and ropes are not permitted at any time. Fabric slings shall be used to lift the pipe, preferably supported at two points along its length. Metal bars, slings, hooks or chains shall not be applied.

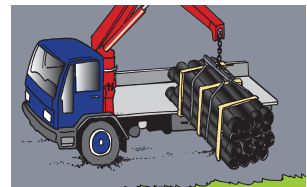

If loading or unloading pipes using forklifts, ensure that only fork lift trucks with smooth forks should be used. Care should be taken to ensure that forks do not strike the pipe when lifting. It is strongly recommended to use protective wrapping over the forks to prevent any sharp edges coming into contact with the insides of the pipes.

If pipes are supplied in pallets, ensure that the slings are to be mounted centrally on the pallet at a distance of 3,5 m. Pallets shall not be moved or lifted with crowbars or poles. When unloading pallets with forklift trucks, ensure that the pallets are put across the forks. It is important to ensure as large a space between the forks as possible for stability of the pallets.

The impact resistance of plastics products is lowered at very low temperatures and under such conditions, extra care during handling is recommended to avoid any sharp impacts at the time of handling or loading and unloading.

#### 5.4. Storage

Although Wavin KG and Wavin X-Stream pipes are extremely light, durable and resilient, the contractor shall take adequate precautions during storage.

Loose pipes and/or pallets shall be stored in a manner so that a proper and stable stack is ensured and on sufficiently solid, level ground. Stack the pipes on surfaces free from sharp objects, stones or projections. If the pipes are stacked on pallets these shall be secured against lateral movements. The smaller diameters can be stored nested (telescoped) in the larger ones, as long as the pipes are supported along their entire length. The stack height of the pipes should not exceed 1,5 m.

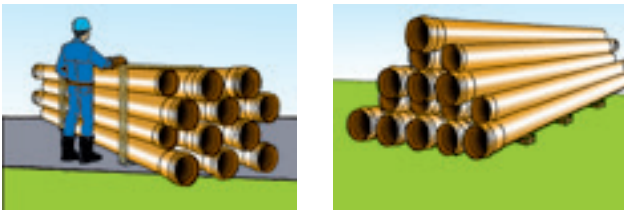

When spacing the pipes the bearing width of the supports and timbers respectively must be at least 7,5 cm. The distance between the supports and timbers respectively should be 1-2 m. The outer supports and timbers respectively are to be arranged 0.5-1.0 m from the stack end.

The influence of weather on stored pipe components should be kept to a minimum, i.e. the pipe components should be kept in a warehouse. If the pipes are stored in the open (construction sites), the area where the pipes are to be placed should be covered with sheeting or cardboard (including the side supports) in order to avoid damage caused by protruding rivets and nails. Moreover, one-sided heat exposure caused by sunshine can lead to deformations in the pipes.

The area where pipe components are stored should provide as much protection as possible. Pipes should be completely protected from the effects of fuels, solvents, oils, greases, paints and other chemical substances or heat sources, during the storage period.

When storing pipes in racks, ensure that any sockets lie alternately within the pile and project sufficiently for the pipes to be correctly supported. When straight pipes are stored on racks, these racks shall provide sufficient side and bottom support to the pipes to prevent permanent deformation. Packaged pipe pallets can be stacked one above the other. The stack height must not exceed 2 pallets. If pipes or fittings are supplied in a bundle or other packaging, the restraints and/or packaging should be removed as late as possible prior to installation.

#### 5.5 Handling and storage inspection chambers & manholes

Wavin Tegra inspection chambers and manholes are tough and relatively light and easy to handle although they can be damaged by sharp objects through scoring or gouging. Therefore it is important that the components are handled sensibly and with care, for the operatives safety as well as for the protection of the components. The components should not be dropped or thrown from vehicles, or dragged across rough ground which may cause damages.

- ⦿ Store on level ground, free of stones and sharp objects
- ⦿ Protect from damage
- ⦿ Stack as shown in the sketch underneath.  
This should be done securely to avoid collapse
- ⦿ Use special hoist elements for transportation with textile straps
- ⦿ Store the rubber ring seals free from frost, preferably at room temperature

## 6. Installation of pipe & fittings

The installation guidance hereafter is not intended to replace the installation regulations as stated in EN 1610. In all cases the requirements stated in the EN 1610 should take precedence.

### 6.1. Safety

Work in trenches is potentially dangerous. Where appropriate, slope the trench walls or use trench sheeting for protection of the operators. Make sure that, when operators are in the trench, any movement of equipment does not cause the trench walls to collapse and that no objects can fall into the trench. Related to this, do not place any excavated material too close to the trench.

**Note:** Attention is drawn to any local and/or national health and safety regulations, a.o. related to protective clothing (helmets), and preventive safety measures around the trenches.

### 6.2. Trench configuration

Generally the trench configuration can be represented as follows:

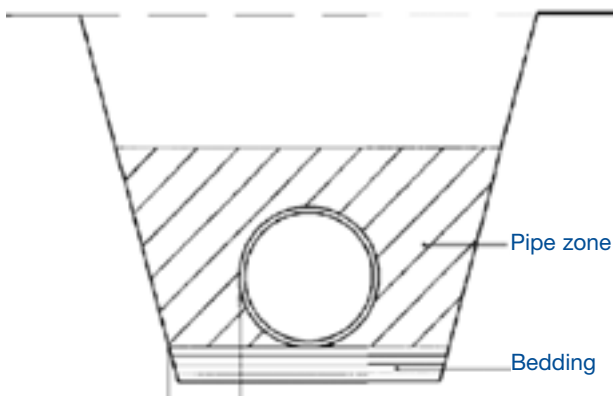

The width of the trench shall provide sufficient space for jointing and compacting the side soil.

Recommended values for the width (in the middle of the pipe) are presented in following table:

Pipe diameter	Trench angle	Trench angle
	> 60°	≤ 60°
DN 200 - 300	0,90	0,90
DN 400	1,00	0,90
DN 450	1,10	0,90
DN 500	1,20	0,90
DN 600	1,30	1,00
DN 800	1,60	1,20

**Note:** if trench depth ≥ 4,00 m: min. width = 1,00 m

Table 8: Recommended minimum trench width at pipe zone (m).

The depth of the trench as well as the gradient of the pipe is determined by the pipeline design. Generally the invert level (bottom-inside surface) of the pipe is prescribed. When determining the trench depth, allowance for a suitable bedding (see below) shall be incorporated.

Parallel piping systems laid within a common trench should be spaced sufficiently far apart to allow proper compaction of the pipe zone backfill material between the pipes. A space between the pipes of at least 150 mm greater than the width of the compactor is recommended.



In the case of unstable ground, e.g. running sand, and high groundwater table, trench support may be required. Besides additional measures such as de-watering of the trench bottom may have to be taken. These measures and how they shall be realized, are the responsibility of the engineer on site.

### 6.3. Pipe laying

Before starting pipe laying, each pipe and fitting should be examined for damage (incl. the sealing ring). Pipes and fittings with too much unacceptable damage should be set aside.

The pipe shall be laid on a proper bedding to provide a continuous uniform support.

In case the bottom of the excavated trench consists of fine-grained soils without sharp objects such as large stones, it is sufficient to level the bottom in line with the required gradient and to loosen the bottom, either with the teeth of the excavator bucket or with a spade.

If not, proper imported granular material shall be used. This material may be gravel, sand or crushed rock, with a maximum particle size of 20 mm. With this a bedding layer of at least 50 mm, but preferably 100-150 mm, shall be made. Some space shall be provided under the planned position of the socket. Ground water swelling up in the trench should be prevented with suitable de-watering.

For the transport of individual pipes and fittings up to DN300 to the pipeline trench, no special lifting equipment is required due to the low weight of the pipes. Do not drag the pipes, as the ends could be damaged from abrasion by rubbing on the ground.

For larger pipe sizes, suitable tools such as wide-area textile slings/belts, etc. should be used in conjunction with a hoist, for lifting or suspension of the pipes, so as to avoid any damage to the pipeline components. Hooks, chains, ropes or other means that can slip or cause any sharp impact loads are not permitted.



At the time of actual laying, it is recommended to install the pipes in such a manner that, once later in operation, the flow direction is from spigot to socket.

It is strongly recommended to insert the spigot in the socket of the previously installed pipe, and it is therefore better to start laying from the downstream part of the section, working upwards. Lay the pipe in the trench so that it bears evenly on the bedding throughout its length.

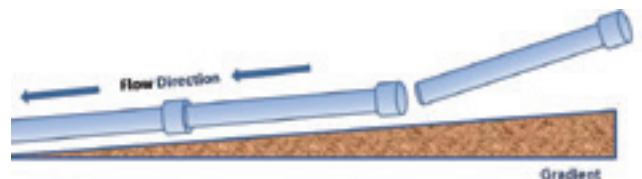



## 6.4. Jointing

Pipes, couplers, bends and junctions may be plain-ended, to be jointed by means of separate couplers, or have integral sockets on or both ends. Elastomeric rings seals fitted in the couplers/sockets act both as a sealing and expansion joint. The pipes and fittings are to be push-fit jointed, thus compressing the sealing ring to be compressed and to form an effective seal.

### 6.4.1. Wavin KG

With Wavin KG pipes, a chamfered end is required. The pipes are properly chamfered when coming from the factory. Pipes cut on site must be clean cut at right angles to their horizontal axis. Deburr the cut end with a scraper and chamfer with a file, ideally under an angle of 15° over a length of approx. 10 mm.

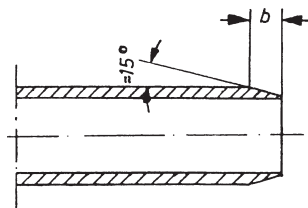

The correct sequence for ring seal jointing is as follows:

1. Check that the pipe is correctly prepared and that the ring seal is properly seated in its housing. Make sure that both the pipe or fitting spigot and ring seal socket are dry, clean and free from grit or dust.
2. Lubricate evenly around the spigot (NOT the socket) with dedicated lubricant or green soap. Make sure that the components to be joined are correctly aligned.

3. Push the spigot fully into the socket. Mark the spigot at the socket face and then withdraw the spigot by a minimum of 12 mm. Prevent soil and dirt coming into the jointing area during assembly.
4. When a lever (crow bar) is used to push the joint home, a block of wood should be placed between the lever and the end of the pipe to prevent the pipe from being damaged. Where mechanical aids (tirfor) are used to facilitate jointing, care should be taken to not damage the pipe.
5. Check if the desired pipe gradient has been achieved, either with laser or with other means of level indication. For example, a gradient of 1:300 on a 6 m long pipe results in a 2 cm higher socket.



The direction of the pipe may be changed at the joint by up to the maximum angle of 0.5 degrees, i.e. 10 cm per 10 m pipe length.

Do not cut back the straight leg sections of Long Radius bends as only the spigot end provided is suitable for jointing.

### 6.4.2. Wavin X-Stream

With Wavin X-Stream pipes the ends are less critical. If a pipe has to be cut, this can be easily done by an electric saw or even by a handsaw. The cut has to be square and in between two corrugations. After cutting, clean the cut surface and remove any swarf.

The joint shall be made as follows:

1. Mark the insertion depth  
The insertion depth for the different diameters is given in the attached table:



Pipe diameter	depth mm
DN 200	126
DN 250	145
DN 300	163
DN 400	200
DN 450	220
DN 500	247
DN 600	295
DN 800	400

Table 9: Insertions depth for Wavin X-Stream.

2. Assemble the sealing ring in the first groove of the pipe



3. Clean and lubricate the socket of the previous pipe  
Clean and lubricate the sealing ring of the new pipe



Green soap is a suitable lubricant. Oil and fats are prohibited.  
Prevent any dirt sticking to the lubricant  
Insertion of the pipe spigot end into the previous pipe

4. Push the pipe home until the marking (stop mark)  
The insertion/pushing shall be done manually.  
Use of a hammer is prohibited.

The patented sculptured socket of the X-Stream pipe makes insertion easy.

In the larger diameters it may be helpful to use a push-pull with a sling around the pipe (in-between the corrugations) or to use a crow bar or the excavator bucket, as long as the socket is adequately protected, e.g. with a piece of wood.

Prevent soil and dirt coming into the jointing area during assembly



**Note:** Be sure not to have the fingers in the groove, whilst the pipe is pushed home.

5. Check if the desired pipe gradient has been achieved, either with laser or with other means of level indication. For example, a gradient of 1:300 on a 6 m long pipe results in a 2 cm higher socket.

The direction of the pipe may be changed at the joint by up to the maximum angle of 2 degrees.

Additional points to be considered for both Wavin KG and Wavin X-Stream installations:

- ⦿ If the work is temporarily interrupted, take care to close-off the ends with suitable plugs to prevent contaminants from entering the installed pipe.
- ⦿ If there is any risk of flotation (e.g. trench flooding caused by a storm) this can be prevented, by backfilling (see 6.5) as soon as possible.

### 6.5. Backfilling & compaction

With backfilling distinction can be made between side fill, initial backfill and final backfill.

The side fill goes up to approximately 2/3 of the pipe diameter. The initial backfill goes up to 30 cm over the pipe crown.

For both the side fill and the initial backfill, as with the pipe bedding, excavated material may be used provided that this material consists of fine-grained soils without sharp objects such as large stones. If not, proper granular material shall be imported from elsewhere. This material may be gravel, sand or crushed rock, with a maximum particle size of 20 mm.

The sidefill material shall be placed in layers on each side of

the pipe and compacted in accordance with the requirements of the project specification (e.g. to the minimum required Proctor density). Make sure that the material under the haunch zones of the pipe is also compacted.

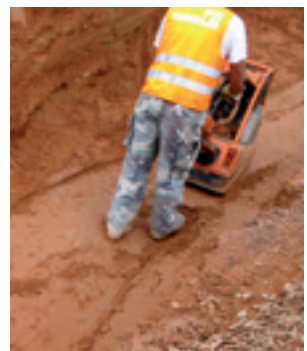
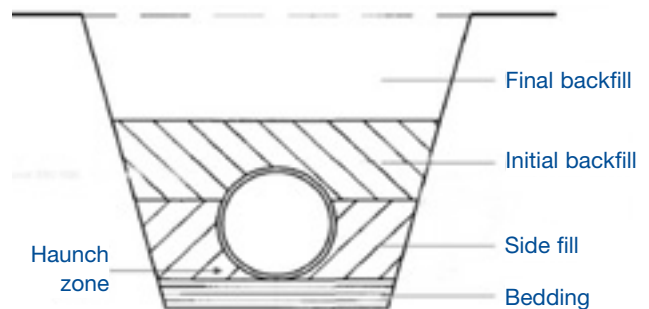

The initial and final backfill material shall be placed by spreading in approximately uniform layers, and compacted in accordance with the requirements of the specification. It is recommended though that the initial backfill has a thickness of 300 mm.

The initial backfill shall not be compacted over the pipe. For the final backfill, excavated material may be used, unless otherwise required by the project specification.

Where trench sheeting is used for trench construction, this shall be removed in such a manner that the compacted backfill is not disrupted. Typically this is done by lifting the sheets in stages, refilling the voids created and re-compacting the soil.

In cases of parallel piping systems laid within a stepped trench (different inverts) the pipe zone fill material shall be granular and shall be well compacted.

## 6.6. Fittings

Assembly of these fittings is very similar to the procedure used for pipe to pipe connections: working clean, lubricate, no use of metal tools, etc.

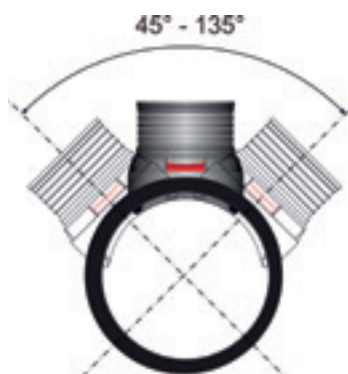

One type of fitting is special from an installation point of view: the Wavin inlet connector, part of both the Wavin KG and Wavin X-Stream system.

The inlet connector is the perfect product for lateral connections, requiring a circular hole to be drilled into the wall of a pipe in such a way as to form a leak-tight connection between the lateral and the main sewer. The pipe is cut with a drilling device to obtain a circular hole appropriate to the inlet connector, taking care to prevent any undesirable materials from entering the pipe. The inlet connector should be positioned on the upper-half of the pipe, either vertically or with its axis maximum 45° to the vertical plane through the longitudinal axis of the pipe.

The assembly of the inlet connector:

- create a hole with a dedicated drill
- set the inlet and check if the seal is properly positioned
- take the two colored levers and start pushing the levers down
- push further downwards
- push until the levers are lying flat

The result is a fully tight connection.



### 6.7. Connection to rigid structures

For connection to rigid structures, in particular concrete manholes, the use of a dedicated protection sleeve in the wall of the structure is required. Such sleeves are part of both the Wavin KG system and the Wavin X-Stream system, especially designed to provide a smooth and tight connection. Distinction can be made between connections to site-fabricated or pre-cast manholes.

Two pipe sections, both spigot-ended, together matching the length required, are needed. The repair sleeve, properly lubricated, is slipped over one of the two sections. The two sections then are positioned in between the last installed pipe and the manhole and the coupler is pushed back in its final position. See figure 17 schematic representations (on the example of X-Stream) for clarification.

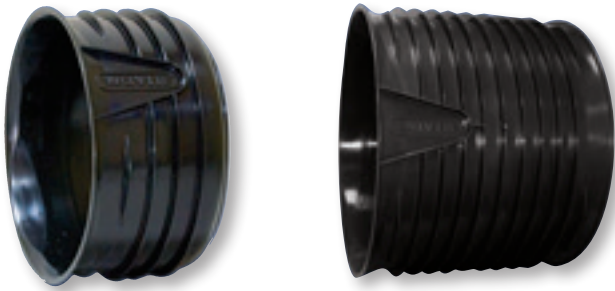

**Note:** With Wavin KG pipes, sometimes Wavin KG single sockets are applied. In that case it helps to apply PVC glue (cement) on the outside with sand, to ensure better fixation.

For site-fabricated manholes, the last to be installed pipe before reaching the planned position of the manhole shall be cut to the appropriate length. Next, the protection sleeve shall be assembled. Finally, the wall of the manhole (and the remainder of the manhole) can be fabricated around it, either with bricks or with concrete. See figure 16 with schematic representations (on the example of X-Stream) for clarification.

For pre-fabricated manholes, apart from the protection sleeve, a repair coupler is also required. It is presumed that the pre-fabricated manhole already contains the protection sleeve. If not, the sleeve shall be assembled (with cement) on site.

**Step-1**

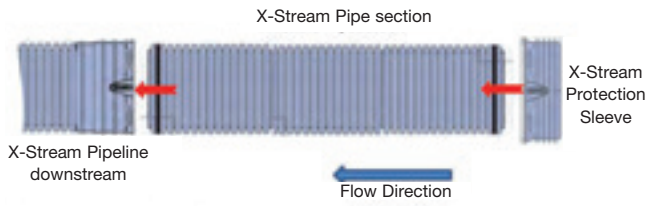

**Step-2**

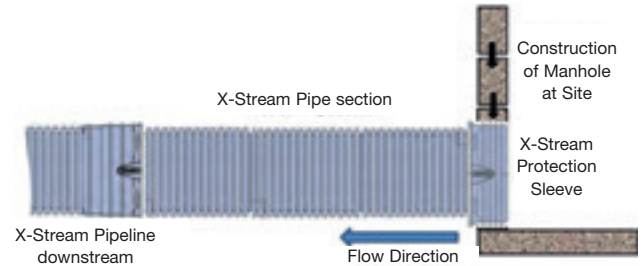
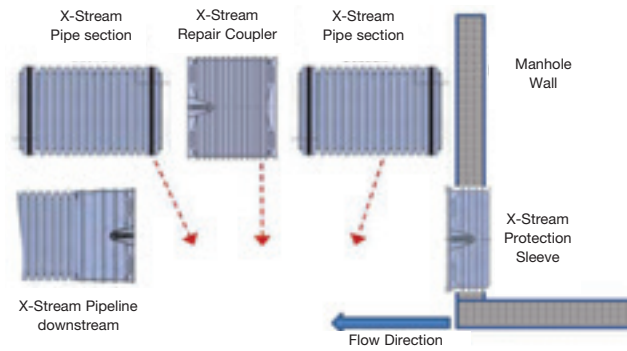

Figure 16: Connection of X-Stream with site-fabricated manholes.

**Step-1**



**Step-2**

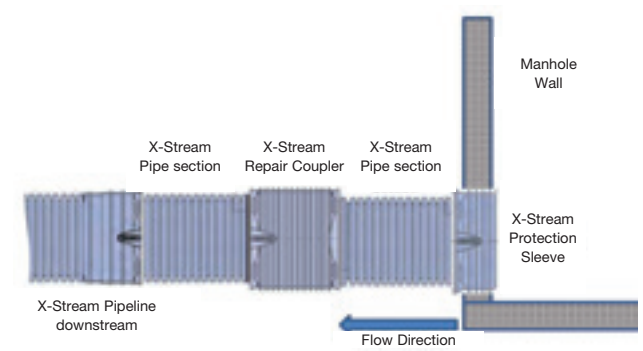

Figure 17: Connection of X-Stream with pre-fabricated manholes.

## 7. Installation of chambers & manholes

The installation guidance hereafter is not intended to replace the installation regulations as stated in EN 1610. In all cases the requirements stated in the EN 1610 should take precedence.

As all Wavin Tegra chambers and manholes are small in size, and consist of light weight modules, the installation is relatively easy and hardly any heavy equipment is required. In most cases they may be installed in pipe trenches without the need to local widening.

Because of their light weight, the base units can be considered as special fittings, only with sockets on both ends. Working upwards along the line as described in clause 6.3 (against the flow direction), the last pipe to be installed before the chamber/manhole, should be cut and the base unit then can be assembled by pushing it over the (new) spigot end of the pipe.

The following pipe can then be inserted with its spigot end into the base unit.

The assembly of the different Wavin Tegra chambers and manholes is described in the following chapters.

### 7.1. Wavin IC range

#### 7.1. Wavin IC 315

The Wavin IC 315 is an easy sewer access point meant to be used in the residential area or as a border chamber between the municipal and public area. Next to the base a single wall corrugated shaft is used, which shaft carries the seal to create a tight solution.

Place the base horizontally on the non-compacted sand bedding 5-10 cm high (levelling layer on the trench bottom). As-dug material may be used as the bedding, backfill and sidefill, provided that it meets all requirements specified for sand beddings, backfill and sidefill materials. The single wall corrugated shaft pipe also allows installation in cohesive soils, like frequently present at non-traffic loaded areas. The corrugated shafts easily follows soil settlements without the risk of excessive loading of the base or creating an offset between cover and ground surface.

Cut the shaft pipe to fit the required height of the chamber on the construction site, using a hand saw.

Fix the sealing ring in the groove of the corrugated shaft and lubricate the base socket. (It is advised to only use professional lubricates, approved for rubber seals and plastics). Fix the shaft pipe in the base socket and push home. This connection is tight.

Backfill the chamber with a loose material; the material must be easy to compact. Backfill layers must be uniformly spread around the shaft pipe. Compact the backfill in layers (layer thickness: up to 30 cm). Soil must be compacted adequately complying to the current in-situ conditions, as well as existing or expected external loads. When provided by local (road) authorities, instructions for soil selection and backfill shall be respected.

The IC 315 is not sensitive to the type of cover used. Direct application of an iron shedded cover is possible but also using a concrete ring around the shaft (on which concrete ring the iron frame and lid is placed) is a good solution. In situations where the iron may be sensitive to theft, a complete concrete solution locally made maybe adequate. The traffic load will always be diverted to the surrounding soil even when initially the cover is supported by the shaft edge. The axial flexibility of the shaft will secure that the load is transferred to the soil and not to the chamber base.

Before applying the cover, the shaft may need to be cut to the correct length depending on the final street / surface level.

### 7.1.2. Wavin IC 400

The Wavin IC 400 is the easiest Wavin access point to install.

Place the base horizontally on the non-compacted sand bedding 5-10 cm high (levelling layer on the trench bottom). As-dug material may be used as the bedding, backfill and sidefill, provided that it meets all requirements specified for sand beddings, backfill and sidefill materials.

Use can be made of locally available, regular PVC-U or PP pipes DN 400 mm pipe for the shaft. Cut the pipe to fit the required height of the chamber on the construction site, using a hand saw. Fix the sealing ring in the groove of the top socket of the base unit and lubricate the base socket. (use only professional lubricates approved for rubber seals and plastics). Fix the shaft pipe in the base socket and push home. This connection is tight.

Backfill the chamber with a loose material; the material must be easy to compact. Backfill layers must be uniformly spread around the shaft pipe. Compact the backfill in layers (layer thickness: up to 30 cm). Soil must be compacted adequately to current conditions in the location, as well as existing or expected external loads.



Figure 18.

### 7.1.3 Wavin IC 450

Place the base horizontally on the non-compacted sand bedding 5-10 cm high (levelling layer on the trench bottom). As-dug material may be used as the bedding, backfill and sidefill, provided that it meets all requirements specified for sand beddings, backfill and sidefill materials. The material needs to be compactable.

Ensure all inlets are free of dirt and grit. Use standard jointing sequence to connect 100/110 mm or 150/160 mm pipes to inlets / outlets. Push blank-off plugs into any unused side inlets. (The main channel must always be used).

Cut the double wall corrugated shaft to approximate invert depth of the chamber. It is recommended to leave for approx. another 300 mm extra length to the shaft, to allow for changes in the final level of the ground surface.

Locate sealing ring between the 2nd or 3rd rib from the shaft bottom end. Ensure the ring is not getting twisted.

Clean inside of the base socket and lubricate the entire internal socket area.

Position the shaft at 45 angle into the base socket. Vertically push home manually or, if required, with mechanical assistance (if so protect top of shaft).

It is considered good practice to cover the top of the chamber before starting backfilling, to avoid dirt getting into the chamber base.

In non-trafficked applications (e.g. garden area), use "as-dug" material (excl. stones >40 mm dia., frozen or vegetable matter). The material must be easy to compact. Backfill layers must be uniformly spread around the shaft pipe. Compact the backfill in layers (layer thickness: up to 30 cm). Soil must be compacted adequately complying to the current in-situ conditions, as well as existing or expected external loads. After installation the compaction should be such that no further post-compaction will occur.



In trafficked applications (e.g. road way), use well compactable soil as backfill material in layers of 150 mm max and compact each layer before applying any subsequent layer.

After the final height has been established and the shaft has been cut off to this final height, locate the sealing ring between the 2nd and 3rd rib from the top of the shaft. Ensure the ring is not twisted.

Lubricate the inside of the 450 to 350 mm restrictor cap, position over top of shaft and push the cap fully home.

Use the appropriate cover and frame to suit the application.

**A15** – Non-loaded green/landscape areas only accessible to pedestrians and bicycles. For this application, galvanised covers and frames are recommended. A concrete ring should always be used. In any case direct load to the top of the shaft should be avoided. See figure 19.

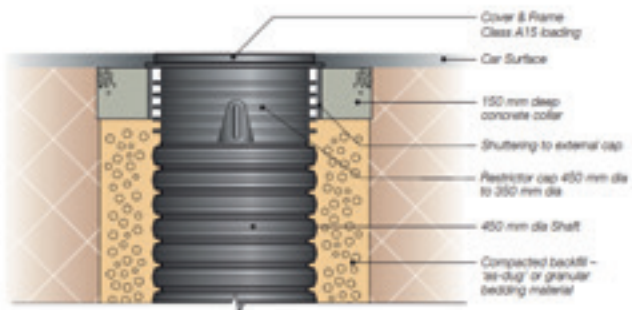

Figure 19: A15 cover solution.

**B125** - paved areas with limited traffic load, where heavy vehicles do not have access

**D400** - roads with heavy duty traffic loads.

For the B125 and D400 type of applications, ductile iron frames and covers shall be applied. A concrete ring shall be used to avoid that direct load is received by the double wall corrugated shaft.

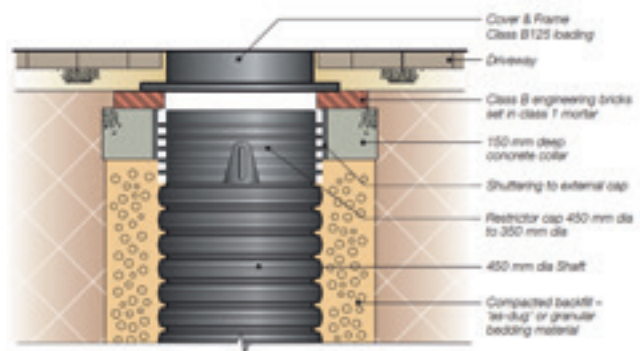

Figure 20: Typical construction for B125 and D400 applications.

# Wavin Tegra range

## 7.2 Wavin Tegra range

### 7.2.1 Wavin Tegra 425

1. Bases are installed on levelled, stable trench bottom. As the bottom of the base unit is double-walled, the trench bottom should be deepened locally with approx. 10 cm. Remove large and sharp rocks from the bottom and form a sand bedding of at least 10 cm thickness.
2. Place the base on the sand bedding and level it out. The level eye situated near the socket can be used as aid.
3. Connect the pipes to the base unit by pressing them into the socket. When connecting Wavin KG PVC smooth-wall pipes, place seals in grooves. With Wavin X-Stream PP twin-wall pipe, place the seal on the pipe, between the two last ribs. Lubricate the pipes and seals. All interconnecting parts shall be clean and free from sand and gravel. Connect sewer pipes adjusting the connection angle (each connector pipe is adjustable within +/- 7.5° in each plane). If possible, divide the total required angle equally over inlet and outlet pipe.
4. In order to fix the assembly it is recommended to backfill the trench at least 10 cm above the top surface of the sewer pipe, leaving the socket for the shaft pipe standing out above the backfill.
5. Cut the shaft pipe either manually or mechanically, in-between ribs, to fit the required height of the chamber.
6. Assemble the sealing ring delivered with the base on the external side of the pipe between 1st and 2nd rib in line with the drawing on the label.
7. Lubricate the internal side of the socket. Protect the connection areas against dirt. Clean if necessary.
8. Insert the shaft pipe with the seal in the base.
9. Backfill the trench layer by layer (max. 30 cm) along the entire circumference of the base.
- 10a. Compact layers of backfill uniformly along the entire circumference of the inspection chamber. Soil must be compacted adequately to the current ground and water conditions as well as the future external load. It is recommended to compact the soil at a minimum SPD level (Standard Proctor Density) of:
  - SPD 90% for green areas
  - SPD 95% for paved areas with limited traffic load
  - SPD 98% for roads with heavy traffic loadIn the case of high ground water level (above the chamber bottom level) it is recommended to adopt a stricter installation regime and increase the degree soil compaction:
  - SPD 95%, 98%, 98%.
- 10b. If applied, it is recommended to use telescopic pipes longer than the structural thickness of surface layers, thus locating the seal between telescopic pipe and shaft pipe below the hard surface.

If a cast-iron cover solution is used with a telescopic pipe, fix the sealing ring delivered with the pipes at the highest groove between the valley of the corrugated pipe. Connect the cover construction with the telescopic pipe (mechanical click connection).
11. When finishing off the top side with asphalt/concrete, the last 4-5 cm should be placed in layers (preferably at least 3) and carry out the following steps to ensure surface and cover integration:
  - a) place the layer, compact it and push the cover body in the layer
  - b) use a crow bar and pull out the cover body together with telescopic pipe
  - c) fill thoroughly the space under the rim with not compacted material of the next surface layer
  - d) repeat a, b and c until getting the designed the required road surface level



### 7.2.2 Wavin Tegra 600

1. Level the bottom of the trench and remove large and sharp stones. Prepare a non-compacted sand bedding 10 cm high.
2. Place the chamber base on the sand bedding. Connect sewer pipes and adjust the angle of the pipe connection precisely (adjustment range: +/- 7.5°). Level out the top of the chamber base.
3. It is recommended to backfill the trench at least 30 cm above the top surface of the sewer pipe. Cover with backfill and compact, layer by layer.
4. Cut the DN 600 corrugated shaft pipe to create the required height of the chamber.
5. Fix the sealing ring delivered with the base in the lowest groove (hollow part) between the outer ribs of the corrugated shaft pipe.
6. As the sealing ring fixed on the corrugated pipe is profiled, its position must be in line with the drawing on the label.
7. The socket of the base unit should be cleaned and lubricated to facilitate the installation of the shaft pipe.
8. Backfill the trench layer by layer. Compact layers of backfill uniformly along the entire circumference of the inspection chamber. Soil must be compacted adequately to the current ground and water conditions as well as the future external load. It is recommended to compact the soil at a minimum SPD level (Standard Proctor Density) of:



- SPD 90% for green areas
- SPD 95% for paved areas with limited traffic load
- SPD 98% for roads with heavy traffic load

In the case of high ground water level (above the chamber bottom level) it is recommended to adopt a stricter installation regime and increase the degree of compaction;

- SPD 95%, 98%, 98%.

Compact the ground around the chamber gradually and in accordance with overall structural design with the guidance provided in ENV 1046. Prevent ovalization of the shaft pipe.

Make sure not to disturb the density, both in the construction phase (e.g. while removing trench sheeting) and afterwards (prevent washing out of fine fractions).

Chamber cover constructions should be in line with the current standard EN 124. This standard also provides the classification of covers by application (location).

For Tegra 600, different types of cast iron covers are used depending on ground conditions, road foundations, and traffic load:

- with a telescopic adapter for covers (adapters may be fixed to cast-iron covers with 4 screws)
- with 615 plastic cone
- with reinforced-concrete supporting ring
- with reinforced-concrete supporting ring and a telescopic adapter for covers

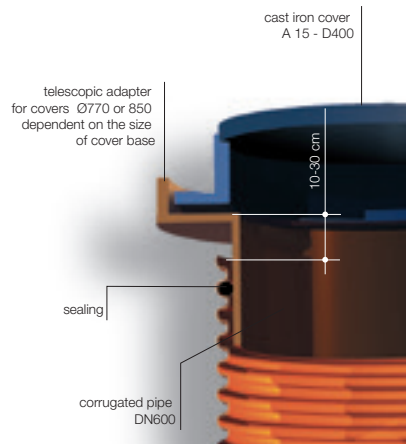

COVER WITH TELESCOPIC ADAPTER FOR COVERS

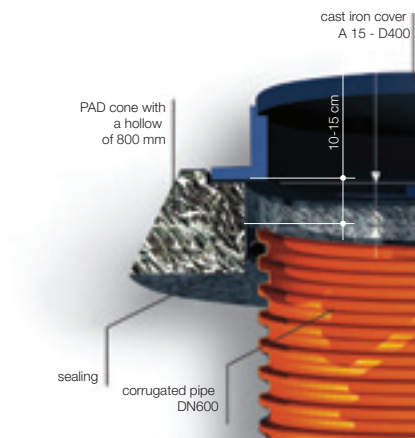

COVER WITH PLASTIC CONE  
Connection with telescopic adapter for covers with 770 flange and covers with base max. 760 mm also possible

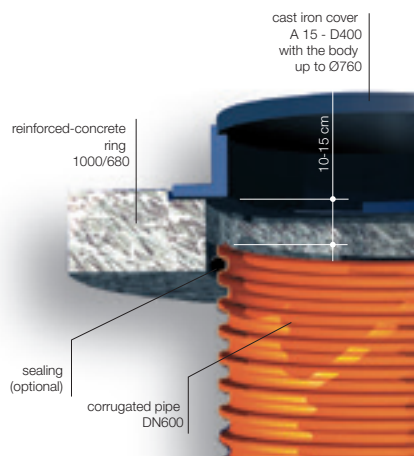

COVER WITH REINFORCED CONCRETE

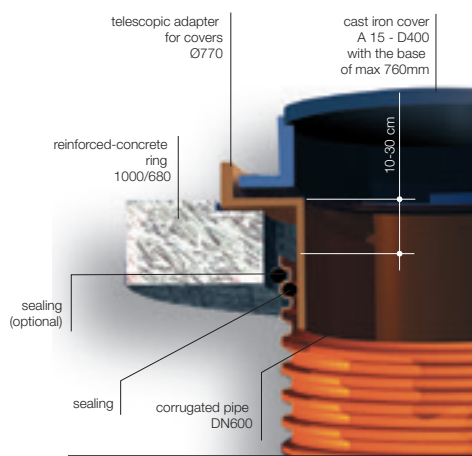

COVER WITH REINFORCED CONCRETE RING AND TELESCOPIC ADAPTER FOR COVERS

# Wavin Tegra 1000 NG

## 7.2.3 Wavin Tegra 1000 NG

1. The Tegra 1000 NG requires a leveled, stable trench bottom. Big, sharp stones shall be removed. Level the bottom of the trench using a suitable bedding material with a minimum layer of 10 cm.

**Note:** The base requires more depth than the pipe system.

2. Apply lubricant to socket in the base unit and push it over the spigot end of the previously installed pipe.

**Note:** Always use professional lubricants approved for rubber seals and plastics.

3. Level the base unit using standard leveling tools (e.g. laser leveling tool).
4. Insert the other pipes, using lubricant, and create the correct angle and gradient. The adjustable pipe sockets enable an angular deflection of  $\pm 7,5^\circ$  from the center line in any direction.

With the X- and Y-type base units, where a side inlet is not used, inlet plugs have to be mounted in the flow profile. On the outside, the respective inlet shall be closed and sealed with a Wavin KG socket plug.

5. To fix the manhole base during installation it is advisable to backfill the trench up to 20 cm above the top surface of the connected pipe(s). Backfill with layers of max. 30 cm of side filling soil and compact carefully.
6. Use corrugated shaft pipe DN 1000 to build up the manhole. If necessary cut the shaft pipe to the required installation height. It is possible to shorten the pipe shaft by using an electric saw or by using a handsaw.
7. Position a DN 1000 outside sealing ring in-between the corrugations (in the valley) and check if the sealing ring is properly installed (see picture).
8. Lubricate base socket with the proper lubricant and connect the shaft pipe with base. During insertion the shaft pipe should be kept perpendicular to the socket. To easy assembly lubricate a sealing ring.

If required the shaft pipe can be elongated with a second section using a double socket and two rings around the shaft pipe on either side.

**Note:** Shaft pipe is cut inside corrugation in the factory. In connection with base and cone sockets shaft pipe can be cut in any place. In connections with using double socket shaft pipe should be cut in outside of the corrugation, in widest place. After cutting clean both ends from feather edges and remove debris.

9. For the cone assembly, a sealing ring shall be placed around the top of the shaft in first complete corrugation. Apply lubricant to the seal and the socket and push down.
10. For shallow installations without a shaft pipe, identify the seal groove on the outside of the cone and remove the cone socket by cutting below the seal groove with an electric saw or handsaw. Place a sealing ring into the seal groove and assemble the cone directly into the base.
11. Backfill the trench around the manhole with loose material, providing a good and even backfill of all free spaces around the manhole. The ground around the manhole should be compacted evenly in layers of max. 30 cm around the entire perimeter of the manhole. Large and sharp stones should be removed from the surrounding area to avoid damage to the manhole outer surface.
12. For the top construction, either a PAD cone, a reinforced concrete supporting ring, a supporting cone or a 615 plastic cone ring can be used, plus a cast-iron cover (frame + lid). To prevent sliding of the cover during subsequent works, fix the cover to its support (cone or concrete ring).

An asphalt layer may be placed on top of the backfill. The cover body should be integrated with the upper surface layer.

**Note:** The Wavin Tegra 1000 NG is available with a ladder construction also. Details are provided in Annex 1.

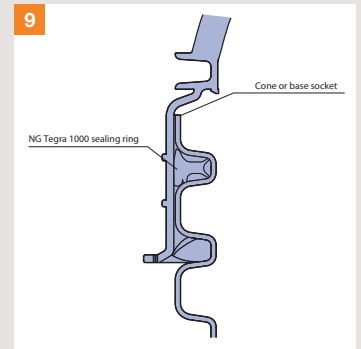
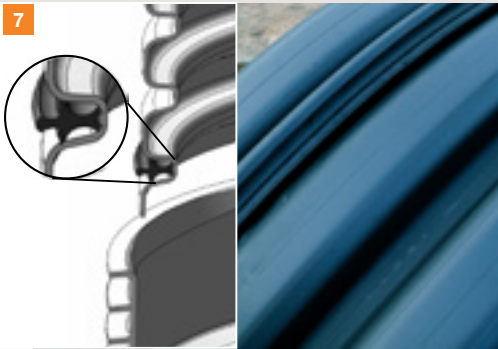

#### 7.4. Shaft inlets

In-situ connectors are available for all Wavin Tegra chambers & manholes to create on site an additional pipe connection to the chamber/manhole shaft.

1. Use the dedicated drill crown saw to cut a hole in the corrugated pipe. Remove sharp edges and clean the opening.
2. Install the special seal in the opening and lubricate it. Insert the special in-situ socket in the opening.
3. The in-situ connector is ready to receive a smooth-wall, PVC sewer pipe.

Creating shaft inlets is possible during the initial installation, but also at a later stage (retro-fit).

In the latter case, dig a trench along the entire circumference of the pipe and after the connection is completed, properly compact the soil around it, in accordance with installation guidelines as prescribed above.





### 7.5. Backdrop configurations

In hilly circumstances, it may be necessary to install a backdrop. With this the downpipe can be positioned either inside or outside of the chamber / manhole.

In the case of non-entry chambers, it generally considered not necessary to install a backdrop. Connections can be made directly to the shaft using the shaft or in-situ connector, even although a backdrop outside is possible.

For the Wavin Tegra 425, in-situ connectors  $\varnothing 110$  and  $\varnothing 160$  are available. For the Wavin Tegra 600  $\varnothing 110$ ,  $\varnothing 160$  and  $\varnothing 200$ .

When the pipe diameter is bigger than the connection to the shaft pipe a reduction is made as shown in the picture. The downpipe is led as the standard backdrop connection by using the vertical pipe or the pipe at the angle of  $45^\circ$ .

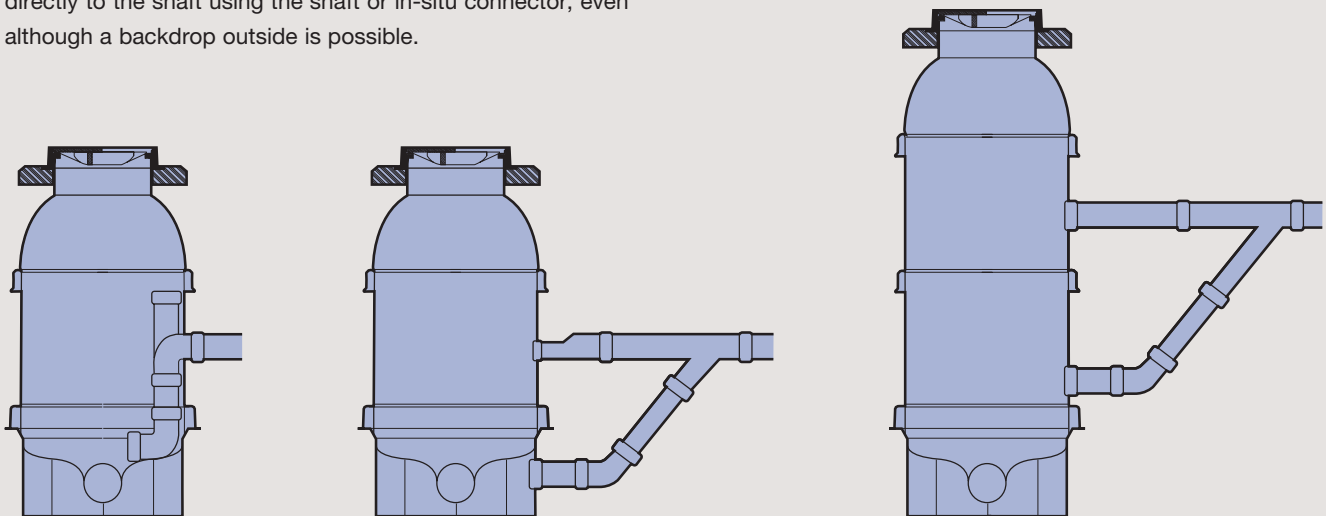

For the Wavin Tegra 1000 generally always a backdrop has to be applied, either inside or outside. For this Tegra 1000 size, also in-situ connectors  $\varnothing 110$ ,  $\varnothing 160$  and  $\varnothing 200$  are available.

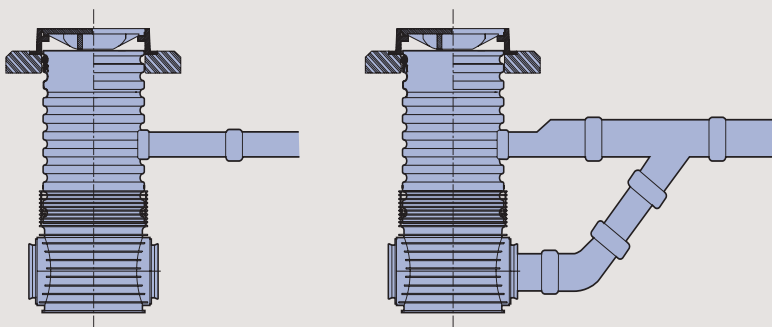

Figure 21: Backdrop configurations for Wavin Tegra inspection chambers & manholes.

# 8. Inspection & testing

When a sewer system is built by Wavin products that are fulfilling the relevant European and ISO standards, then the Inspection and Testing can be limited to a CCTV inspection or a visual inspection during installation. The CCTV and / or visual inspection should focus on correct assembly of the components, like checking insertion depth in sockets and inspection chambers / manholes. Such a visual / CCTV inspection is more than sufficient, as tightness and structural issues are well secured by the system and product standards. In case Wavin products are combined with other products that fulfill the same standards then this also applies. However when Wavin products are combined with other non-certified products then further tightness testing might be required.

Tightness testing can be done either with water or with air. In both cases, adequate care shall be taken to ensure that the ends and connections are properly sealed off before the test is started.

## 8.1 Tightness testing with water

Gradually filling of the pipeline section shall be done with sufficient de-aeration at the highest point (upstream).

Initial filling time: 1 hour

Dealing with the pipe section separately,  
permissible volume of water to be added,  
in accordance with EN 1610: 0,15 l/m<sup>2</sup> \*)

Test pressure equal to the depth of the manhole with a maximum of 5 meter water column which is equal to 0.5 bar.

Duration: 30 minutes.

\*) for pipelines including manholes: 0,20 l/m<sup>2</sup>

for pipelines including manholes and  
inspection chambers: 0,40 l/m<sup>2</sup>



The respective water volumes are given in the table.

Internal pipe diameter (mm)	Volume (l/m of pipe)	Permissible added amount (l/m of pipe)
150	18	0,071
200	31	0,094
250	49	0,118
300	71	0,141
400	126	0,188
500	196	0,236
600	283	0,283
800	503	0,377

Table 10: Testing with water.

## 8.2 Tightness testing with air

Air testing is permitted and repeatable as many times as found necessary (corrective measures can be taken after every time).

Where testing with air does not give a satisfactory result, testing with water can be done instead. In that case, only the test results with water shall be applicable.

Test condition to be defined by the specifier (LA, LB, LC, LD). For Wavin KG and X-Stream sewer pipelines, the respective test pressures and test times are given in the table.

Relaxing time (after initial pressurization), in accordance with EN 1610: 5 minutes.

Test condition	LA	LB	LC	LC
Test pressure (bar)	0,01	0,05	0,1	0,2
All. press. drop (mbar)	2,5	10	15	15

Pipe diameter (mm)	Test time (min)			
	LA	LB	LC	LC
150	5	4	3	1,5
200	5	4	3	1,5
250	7	6	4	2
300	7	6	4	2
400	10	7	5	2,5
500	14	11	8	4
600	14	11	8	4
800	19	15	11	5

Table 11: Testing with air.

# 9. Standards & certificates

Wavin products meet the requirements of the relevant international and national standards with regard to dimensions, identification, materials and mechanical and physical properties.

In general, the relevant standards can primarily be divided into three main groups:

<b>EN</b>	European Committee for Standardisation
<b>ISO</b>	International Organisation for Standardisation
<b>DS, BS, NF, NEN, etc.</b>	National Standards bodies

## 9.1. Standards related to sewers

Following standards are relevant to the product ranges dealt with in this Wavin Sewer Manual:

<b>EN 124:</b>	Gully tops and manhole tops for vehicular and pedestrian areas Design requirements, type testing, marking, quality control, 1994
<b>EN 476:</b>	General requirements for components used for gravity sewer systems, 2011
<b>EN 752:</b>	Drain and Sewer systems outside buildings. 2008
<b>ENV1046:</b>	Plastics piping and ducting systems - Systems outside building structures for the conveyance of water or sewage - Practices for installation above and below ground, 2001
<b>EN 1295 -1:</b>	Structural design of buried pipelines under various conditions of loading – Part 1: General requirements. 1997
<b>EN 1401 -1, -2, -3;</b>	Plastics piping systems for non-pressure underground drainage and sewerage - Unplasticized poly(vinyl chloride) (PVC-U) – Part 1: Specifications for pipes, fittings and the system. 2007 Part 2: Guidance for assessment of conformity. 2007 Part 3: Guidance for installation. 2007
<b>EN 1610:</b>	Construction and testing of drains and sewers. 1997
<b>EN 13476 -1, -2, -3;</b>	Plastics piping systems for non-pressure underground drainage and sewerage – Structured-wall piping systems of unplasticized poly(vinyl chloride) (PVC-U), polypropylene (PP) and polyethylene (PE) – Part 1: General requirements and performance characteristics. 2007 Part 2: Specifications for pipes and fittings with smooth internal and external surface and the system, Type A. 2007 Part 3: Specifications for pipes and fittings with smooth internal and profiled external surface and the system, Type B. 2007
<b>EN 13508 -1, -2:</b>	Condition of drain and sewer systems outside buildings – Part 1: General requirements, 2002 Part 2: Visual inspection coding system, 2003

- EN 13598-1, -2, -3:** Plastics piping systems for non-pressure underground drainage and sewerage – Unplasticized poly(vinyl chloride) (PVC-U), polypropylene (PP) and polyethylene (PE) –  
 Part 1: Specifications for ancillary fittings including shallow inspection chambers. 2005  
 Part 2: Specifications for manholes and inspection chambers in traffic areas and deep underground installations. 2009  
 Part 3: Guidance for assessment of conformity. 2012

**Note:** Since this standard comprises a wide range of possible applications of chambers/manholes, it requires the manufacturer to declare a.o. the allowable depth of cover, ground water table and traffic load. Only minimum values are required, such as minimum allowable ground water table of 2 m. (Wavin Tegra chambers/manholes all exceed this, see table ‘Overview Tegra chambers’, chapter 3).

The standard also requires tightness of joints to chambers/manholes, such as tightness with 5% vertical pipe deflection and, in addition, at least 2° angular deflection.

- 
- ISO 4435:** Plastics piping systems for non-pressure underground drainage and sewerage – Unplasticized poly (vinyl chloride) (PVC-U). 2003

- 
- ISO TR 7073:** Recommended techniques for the installation of unplasticized poly (vinyl chloride) (PVC-U) buried drains and sewers. 1998

- 
- ISO TR 10358:** Plastics pipes and fittings – Combined chemical-resistance classification table. 1993

- 
- ISO 21138 -1,-2:** Plastics piping systems for non-pressure underground drainage and sewerage – Structured-wall piping systems of unplasticized poly(vinyl chloride) (PVC-U), polypropylene (PP) and polyethylene (PE) –  
 Part 1: Material specifications and performance criteria for pipes, fittings and system  
 Part 2: Pipes and fittings with smooth external surface, Type A  
 Part 3: Pipes and fittings with non-smooth external surface, Type B

- 
- DS 2379:** Inspection chambers of PVC-U, PE and PP for buried pipelines for transport of sewage and rainwater – Specifications and test methods. 1990

## 9.2. Certificates

All Wavin products comply with the respective European standards and all products are third-party certified. Selections of the product certificates are presented alongside the product ranges in chapters 2 and 3. Available on request.

Wavin Overseas operates under a Quality Management System, which is accredited to EN ISO 9001:2000 by the Dutch Council for Accreditation. We constantly strive to enhance this QA-system in order to improve customer satisfaction.



# Annex 1 – Ladder assembly in Wavin Tegra 1000 NG

For the Tegra 1000 NG a dedicated ladder can be applied. This ladder is made of corrosion free GRP, complying with the highest safety requirements. The ladder hangs on the support integrated in the cone and is fixed inside the corrugated shaft using stainless steel circular strips that fit in to the corrugations.

The Wavin Tegra 1000 NG ladders are offered in 4 types:

- 6, 8, 14 and 18 steps

From these available types, the suitable length relative to the shaft height (see 4.2.3) can be selected and where needed can be cut on-site using a hand or power saw.

The upper and bottom sections of the legs should extend at least 50 mm.

Shaft pipe height (m)	Steps	Ladder length (m)	Brackets	
≤ 0.5	3	0.73	1	
0.6 - 0.8	4	1.03		
0.9 - 1.1	5	1.33		
1.2 - 1.4	6	1.63		
1.5 - 1.7	7	1.93		
1.8 - 2.0	8	2.23		
2.1 - 2.3	9	2.53		
2.4 - 2.6	10	2.83		
2.7 - 2.9	11	3.13		2
3.0 - 3.2	12	3.43		
3.3 - 3.5	13	3.73		
3.6 - 3.8	14	4.03		
3.9 - 4.1	15	4.33		
4.2 - 4.4	16	4.63		
4.5 - 4.7	17	4.93		
≥ 4.8	18	5.23		

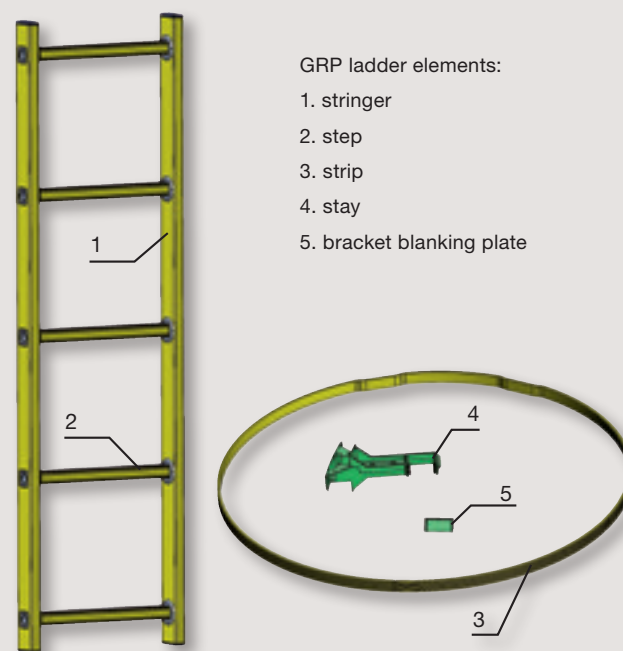

Table 12.

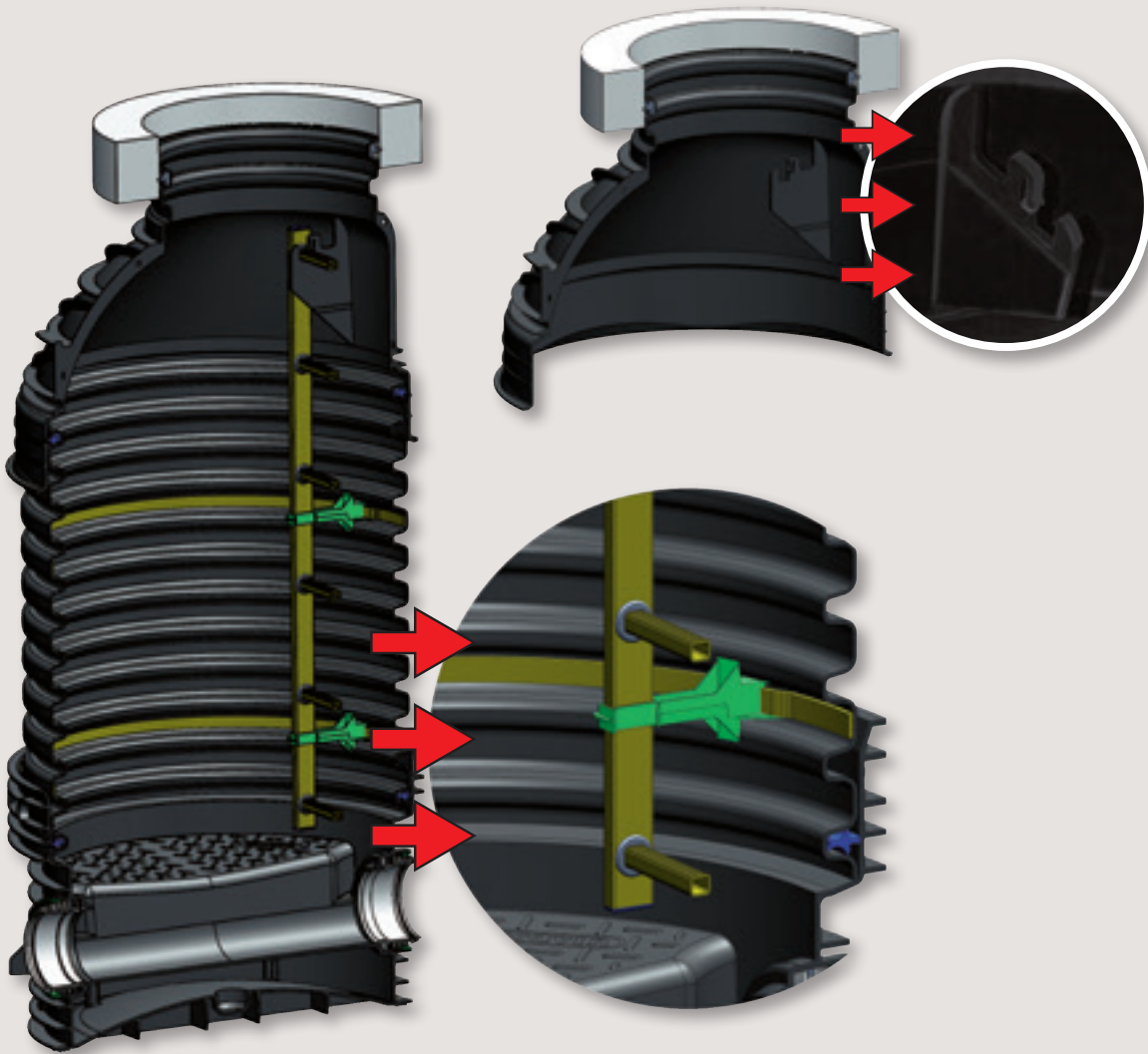

Figure 22.

# Annex 2 – Top construction Tegra chambers & manholes

Chamber and manhole top constructions should be in line with the EN 124. This standard also presents the classification of covers by location.

Presented below are typical cover solutions for Wavin Tegra chambers & manholes.

Different types of cast iron covers are used depending on ground conditions, road foundations, and traffic load.

Cover types:

- with a telescopic adapter for covers
- with 615 plastic (PAD) cone
- with reinforced-concrete support ring
- with reinforced-concrete support ring and a telescopic adapter for covers

Telescope adapters may be screwed to cast-iron covers with 4 screws.

## Cover classes:

- **Class A15**
  - (cast iron or PE) used only in footways, bicycle tracks and areas not loaded by traffic
- **Class B125**
  - used in footpaths and areas for pedestrians, equivalent areas, parking lots or any areas for parking cars
- **Class D400**
  - used in motorways, paved road shoulders, and parking areas for all types of road vehicles

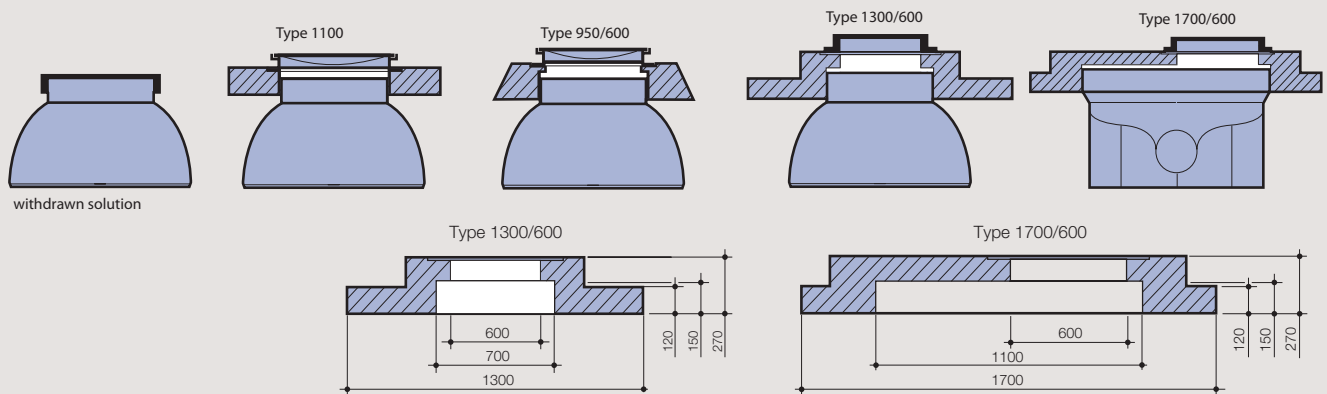

Figure 23.



**Support ring types:****› Universal plastic PAD cone 615**

- designed for use under the manhole cover is a lighter alternative solution for concrete and reinforced-concrete rings. This ring is made of mixed polymeric plastic materials basing on thermo-plastic materials: PVC, PE, PP and PEX. The cone is designed for:
  - adjusting the chamber height to the surrounding surface and for adjusting the surface level to covers
  - protecting the shaft pipe against damages caused by traffic loads
  - transferring traffic loads from the chamber/manhole to its surrounding soil
  - damping and dispersing vibrations caused by traffic

The cone complies to EN 124 and is compatible with cover class D400. Due to its shock-absorption features (40% of energy is absorbed and dispersed) and flexible integration with asphalt surface the cone is a highly reliable element of so called “floating” covers for Tegra 1000 chamber. This element may be used as a support for manhole/chamber covers of classes A15 to D400.

**› Reinforced concrete ring Type 1300/600**

- standard solution for Tegra 1000

**› Reinforced concrete ring Type 1700/600**

- for Tegra 1000 without cone





## Discover our broad portfolio at [wavin.com](http://wavin.com)

Hot & Cold Water

Foul Water

Gas & Water Mains

Indoor Climate

Storm Water

Geotextiles

Soil & Waste

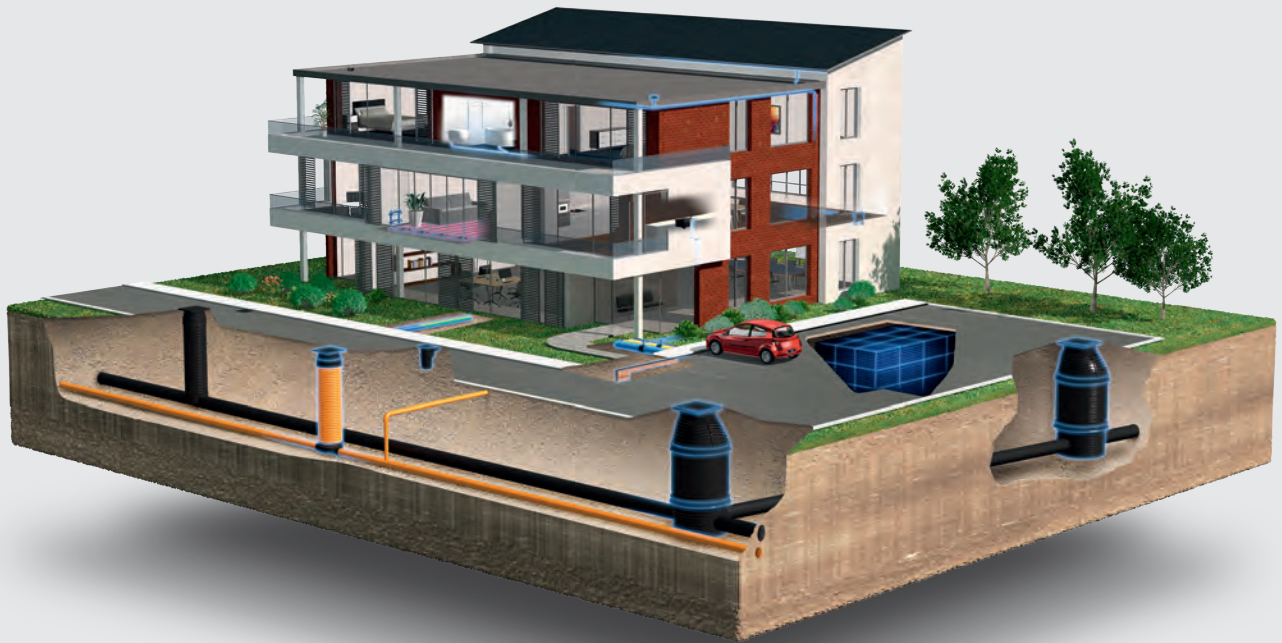

Wavin is part of Orbia, a community of companies working together to tackle some of the world's most complex challenges. We are bound by a common purpose: To Advance Life Around the World.



**WAVIN ASIA PACIFIC** E-mail [wavinapac@wavin.com](mailto:wavinapac@wavin.com) | Internet [www.wavin.com/asia](http://www.wavin.com/asia)



Wavin operates a programme of continuous product development, and therefore reserves the right to modify or amend the specification of their products without notice. All information in this publication is given in good faith, and believed to be correct at the time of going to press. However, no responsibility can be accepted for any errors, omissions or incorrect assumptions.

© 2019 Wavin Wavin reserves the right to make alterations without prior notice. Due to continuous product development, changes in technical specifications may change. Installation must comply with the installation instructions.