

design · planning · installation

# Sound insulation for greater living comfort

Practical knowledge in sanitary engineering



An Orbia business.

# Three decades of know-how in sound insulation for your construction project

Whether for renovation or new construction, residential or non-residential, hotel, hospital, retirement home: Sound-optimised rooms are an essential quality feature of real estate.

Implementing the best possible sound insulation in the sanitary area at a reasonable cost is anything but trivial. A vast range of influencing variables, calculation models, and pipe systems need to be included in planning. Noise regulations and complex requirements from investors, owners and building users are added to this.

Our noise control expertise has grown over more than 30 years: After all, we invented the first plastic drinking water pipe and the first plastic sound insulation pipe in the wastewater sector. Even today, Wavin is considered an innovator in drinking water installations, heating, storm water and wastewater piping and building drainage.

We would like to offer our expertise in sound insulation, water supply and drainage systems from architectural and economical design, to efficient and safe planning, to defect-free installation. Architects, planners and installers can reliably control the noise of their sanitary systems with this practice brochure and our system solutions.

**Please do not hesitate to contact us if you have any questions.**

Contact our experts:  
in the local organisations



**Note:** In this acoustic brochure, reference is made for the most part to standards and regulations from Germany. The local specifications in the respective countries always have equal priority and are observed there.



WAVIN AS  Astolan® PP Z-42.1-228 Ü DN 70 DIN 4102 B2Φ 14.02.13

WAVIN AS  Astolan® PP Z-42.1-228 Ü DN 70 DIN 4102 B2Φ 14.02.13

**More than three decades of safe premium sound insulation with Wavin AS**  
Have a look at this example of the Steigenberger Hotel, Bremen



# Contents

<b>Introduction</b>	<b>06</b>
Acoustics basics	07
Compact sound insulation knowledge for architects	14
Compact sound insulation knowledge for planners	15
Compact sound insulation knowledge for installers	17
<b>Sound insulation in architecture</b>	<b>18</b>
Design basics for optimal sound insulation	20
The components for optimum sound insulation	24
Practical advice	25
<b>Sound insulation in planning</b>	<b>26</b>
Basics of planning supply and disposal lines	28
Wastewater plant design	32
Planning of drinking water installations	34
Practical advice	39
<b>Sound insulation during installation</b>	<b>40</b>
The right choice of materials for best sound insulation	42
Installing the sound insulation components	45
Sound insulation requirements during installation	48
Practical advice	53
<b>Acoustic system testing</b>	<b>54</b>
Testing according to DIN EN 14366	56
Measurement according to DIN 4109	57
System testing according to DIN 4109	58
Fraunhofer IBP test reports	59
List of abbreviations	65
Bibliography	65



## Introduction

# As little noise as possible. For greatest quality of life.

Water supply and drainage pipes and other installation elements generate noise inside buildings that can be annoying and affect quality of life. This must be adequately countered with appropriate sound insulation measures – in particular in apartment buildings and other properties shared by many.

The effects of inadequate sound insulation in installation technology are particularly clear in old buildings. You might notice when your neighbour above or next to you is using the toilet. Water may be rushing through the pipes as loudly as if you were standing next to a raging river. Optimising sound insulation requires understanding of the core concepts and exactly how to apply them in architecture, planning and installation.

# Acoustics basics

The necessary physical core terms for measurement and evaluation of a sound event are briefly explained below. In other chapters of the brochure will deepen this basic

knowledge in a practical manner for application in the fields of architecture, planning and installation.

## Sound

Sound is generated by mechanical vibrations of an elastic medium. For example, this is the case when air molecules are

moved. Gases, liquids, and solids can generate sound that propagates as a sound wave.

### These types of sound are relevant in building construction:



⌚ **Airborne sound** is generated, for example, by people, machines, or even by flowing water in pipes and propagates through the air.

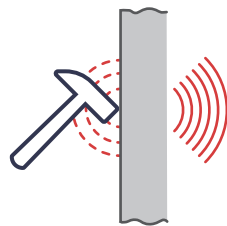

⌚ **Structure-borne sound** originates in solid bodies and propagates at the surface as airborne sound. In pipe installations, this happens mostly through pipe clamps and brackets in the wall.

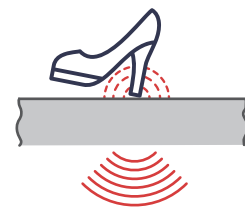

⌚ **Impact sound** is a special form of structure-borne sound caused by footsteps or falling objects. It propagates as airborne sound

## Frequency spectrum

100 to 3,150 Hz are considered the relevant range for building acoustics, i.e., structural sound insulation. In room acoustics, on the other hand, the frequency interval is from 63 to 8,000 Hz. Our hearing perceives sinus tones of different frequencies at

different volumes. They indicate the sound pressure level that produces the same loudness impression as a sinus tone with a frequency of 1,000 Hz. Human hearing is the most sensitive between 2,000 and 5,000 Hz, by the way (see also figure 1 and 4).

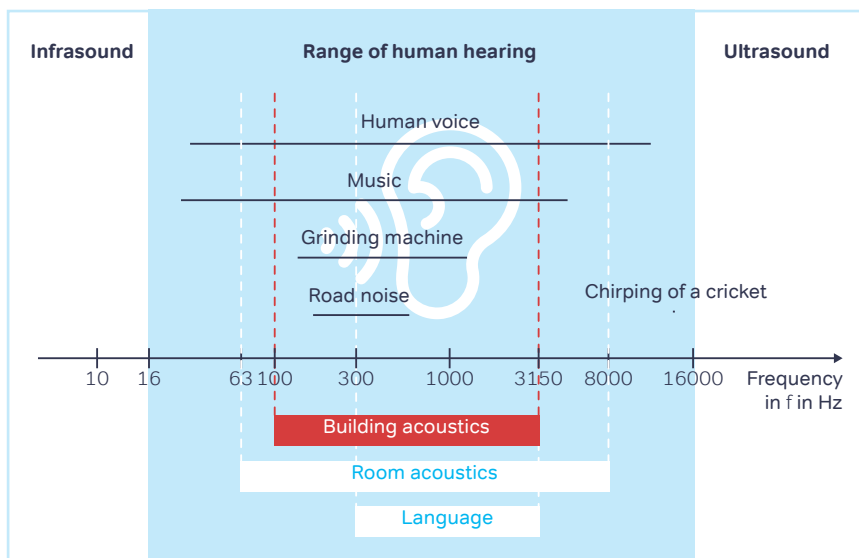

**Figure 1:** Presentation, naming, and examples of different ranges of the frequency band (source no. 6)

# Frequency weighting

There is a frequency-dependent relationship between sound pressure level and loudness perception. This is represented with frequency weighting filters.

These filters reduce the sensitivity of the meter at low and high frequencies to adjust it to the sensitivity of human hearing. Noise measurements are usually evaluated using the A weighting curve. Their measured values are given as A sound pressure level in dB(A).

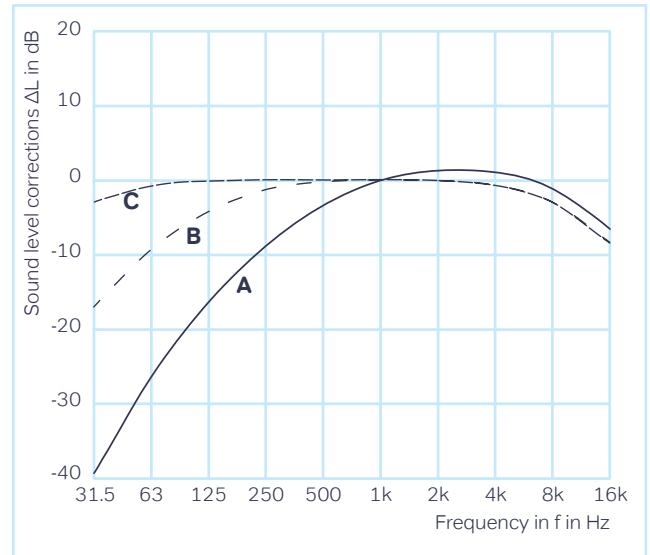

Figure 2: Sound pressure level correction ΔL according to DIN EN ISO 16032 (or the withdrawn DIN EN 60651) for ratings A, B, and C

# Sound pressure

The amplitude of sound vibrations is considered to be the sound pressure. The magnitude of the amplitude starts in the audible range at 20 μPa, and the pain threshold is reached at 20 Pa. The sound pressure knows no upper limit; it depends solely on the sound-generating energy used. (Source no. 6)

The sound pressure level  $L_p$  is calculated as follows:

$$L_p = 10 \cdot \lg \frac{p^2}{p_0^2} = 20 \cdot \lg \frac{p}{p_0}$$

Wherein:

- $L_p$  Sound pressure level in dB
- $p$  Sound pressure in Pa
- $p_0$  Reference value (hearing threshold with  $p_0=20 \mu\text{Pa}$ )

If two sound sources of the same strength are added, the result is 3 dB higher.  
**50 dB + 50 dB = 53 dB**

	Sound pressure level $L_p$ in dB	Noise
	0	Hearing threshold
	15 - 20	Quiet rustle of leaves
	30 - 40	Quiet residential area
	40 - 50	Quiet conversation, quiet office
	50 - 60	Normal entertainment
	70 - 80	Heavy road traffic
	80 - 85	Shouting, screaming
	80 - 90	Truck passing by
	90 - 100	Compression air hammer at a distance of 10 metres
	100 - 110	Fast train passing by
	110 - 120	Circular saw
	120 - 130	Propeller plane at 3 m distance

Figure 3: Examples of sound pressure levels



# The loudest noise in the world



**172 dB**

At a distance of 160 km.

## **Eruption of Krakatau (1883), Indonesia**

The volcanic eruption was so loud that it could still be heard 4,800 kilometres away on Rodrigues Island in the Indian Ocean. Imagine hearing a noise in New York that originated in Dublin, Ireland!

## Introduction

### Third octave level, octave level, total level

Noise usually consists of many different frequencies. Frequency spectra show which frequencies are represented in the noise and to what extent. The frequency range is divided into frequency bands for examination. Depending on the width of the bands, they are called third-octave bands or octave bands. Filters for measuring these bands are built into many modern meters. Which frequency range is relevant in building acoustics? That depends on the task. For example, the frequency range between 100 and 5,000 Hz is important for sound attenuation measurements. Short methods evaluate octaves between 125 and 2,000 Hz.

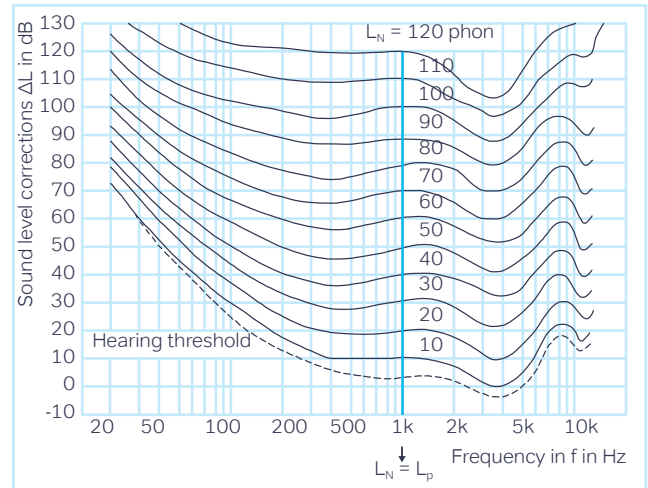

**Figure 4:** Connection between subjectively perceived sound volume  $L_N$  and objectively measurable sound pressure level  $L_p$ .  $L_N$  and  $L_p$  only match at the frequency  $f = 1000$  Hz.

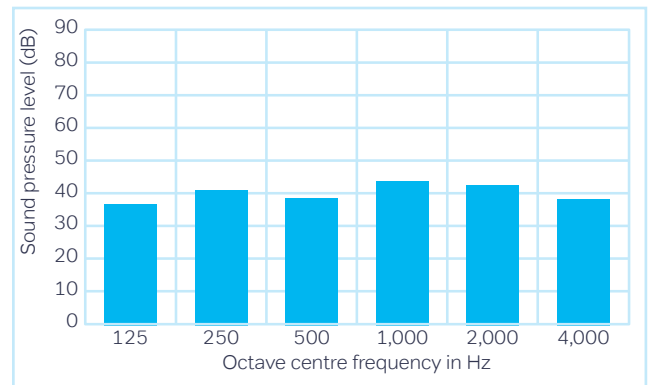
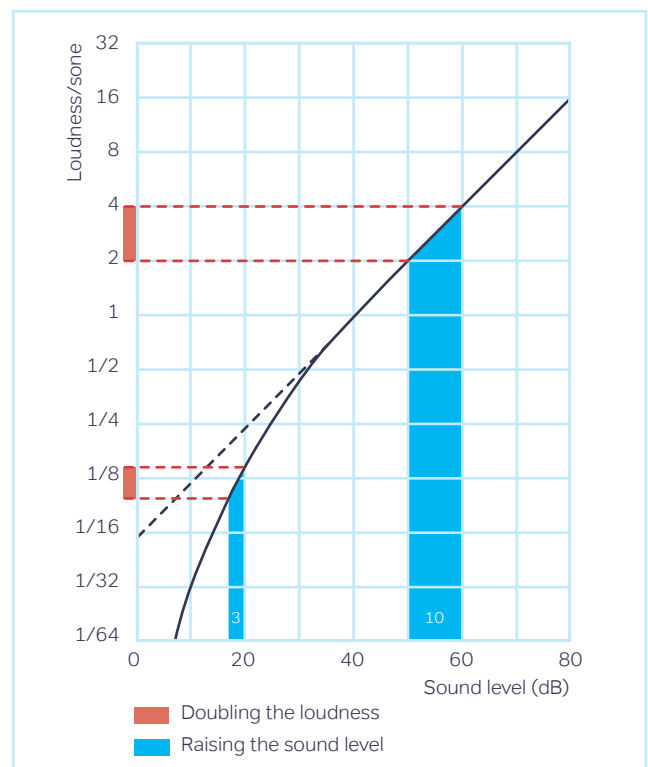

**Figure 5:** Octave spectrum

### Loudness perception and frequency weighting

Human perception of sound volume is subjective and depends on frequency: We perceive sounds of low and high frequencies to be considerably quieter than sounds with medium frequencies at the same sound pressure level.

If sound pressure levels above 40 dB are reached, human hearing can perceive changes of 1-2 dB. A stronger, significant change in loudness is achieved from an increase in sound level of 3 dB. Particularly interesting: Sound volume according to Zwicker is not linear below 40 dB; thus, changes of 3 dB already lead to a doubling of the loudness. This refers to the specifications that must be achieved according to DIN 4109.



**Figure 6:** Subjective perception of sound volume according to Zwicker

## Airborne sound insulation/sound transmission paths

Sound transmission between two rooms in buildings happens via the separating building part as well as via flanking building parts and also via pipes, leaks, ventilation systems, etc. Therefore, two terms are distinguished from each other (source no. 7):

- ⌚ Secondary transmission: Any form of airborne sound transmission between two adjacent rooms via leaks, ventilation systems, pipes, and the like.
- ⌚ Flank transmission: Secondary transmission exclusively via building parts

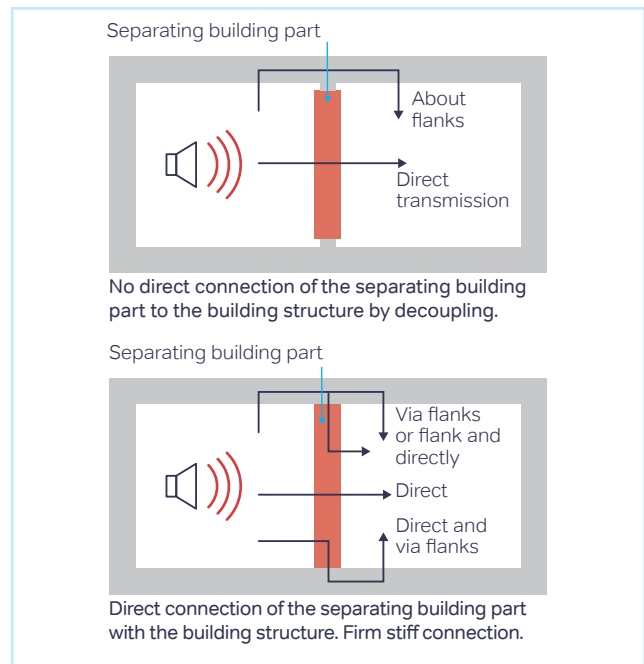

Figure 7: Information on the possible transmission paths for different building parts

## Reverberation time and sound absorption area

Sound absorption is the equivalent absorption area  $A$ , which can be determined from the reverberation time of a room. The reverberation time therefore indicates how long the sound in a room/shaft can still be heard after the sound originator is no longer present. The reverberation time can be used to determine the absorption coefficient of the room or shaft. Both are frequency dependent.

$$A = 0.163 \cdot V/T$$

$A$  = Equivalent sound absorption area of a room in  $m^2$

$V$  = Volume of the room under consideration in  $m^3$

$T$  = Reverberation time in the room in s

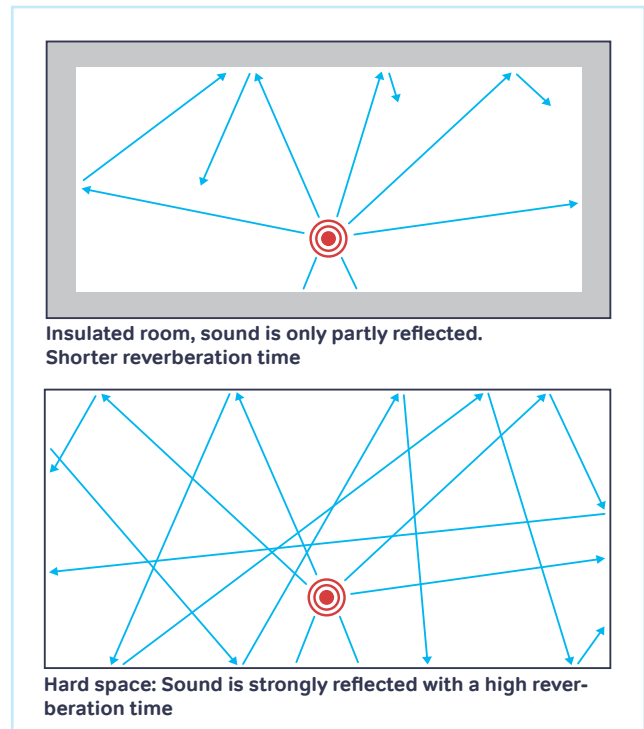

Figure 8: Sound reflection

## Sound transmission from building services equipment

According to the definition of DIN 4109, technical building systems are supply and disposal systems in buildings, transport systems, permanently installed operational, and other technical building systems. Building services equipment is particularly difficult to deal with from a sound engineering point

of view since the sound sources generate both airborne sound and structure-borne sound. Only general advice can be given to the architect and planner, for example on floor plan design while there is no reliable forecasting method for this.



## DIN 4109

No one wants to hear noises from building services, whether it's a shower or a toilet flushing. The minimum requirements to sound insulation are anchored in DIN 4109 in Germany. DIN 4109 is the authoritative standard for sound insulation in buildings. To achieve sound insulation targets, DIN 4109 describes the permissible sound levels for building parts in protected rooms.

### Rooms to be protected:

- ④ **Living rooms** (including floorboards and kitchens)
- ④ **Dormitory rooms** (including accommodation rooms in lodging establishments)
- ④ **Patient rooms in hospitals and sanatoriums**
- ④ **Classrooms in schools, colleges, and similar institutions**
- ④ **Office space**
- ④ **Practice rooms, meeting rooms and similar work rooms**

As a rule, a sound pressure level of 80 dB(A) must not be exceeded in the living space. The permissible sound pressure levels in the receiving room – i.e., the room where the sound arrives – are between 30 and 40 dB(A).

As a generally recognised technical rule, DIN 4109 is legally relevant. The standard does not specify a particular structure for sound insulation measures. Therefore, compliance with DIN 4109 is checked with sound measurements under realistic conditions on the object.

The characteristic quantity for noise from sanitary engineering is the A-weighted sound pressure level  $L_{AF, max,n}$ . One key requirement here is that noise emissions from drinking water and wastewater systems must be considered together. The required sound insulation certificates also must be provided in accordance with DIN 4109-1.

According to DIN 4109, there are two options for proving the suitability of wastewater installations from an acoustic perspective:

**1. Building acoustics measurement and testing** of a sanitary installation with integrated wastewater pipes according to DIN 4109-4 "Testing of acoustics in buildings" with the measurement and at the same time requirement variable  $L_{AF, max,n}$ .

**2. Computational verification according to DIN 4109-2** "Verification of compliance with the requirements by calculation" in conjunction with DIN 4109-36 "Data for verification of sound insulation (component catalogue) - Technical equipment", using the test results according to DIN EN 14366. (Source no. 7)

DIN 4109-4 Testing of acoustics in buildings

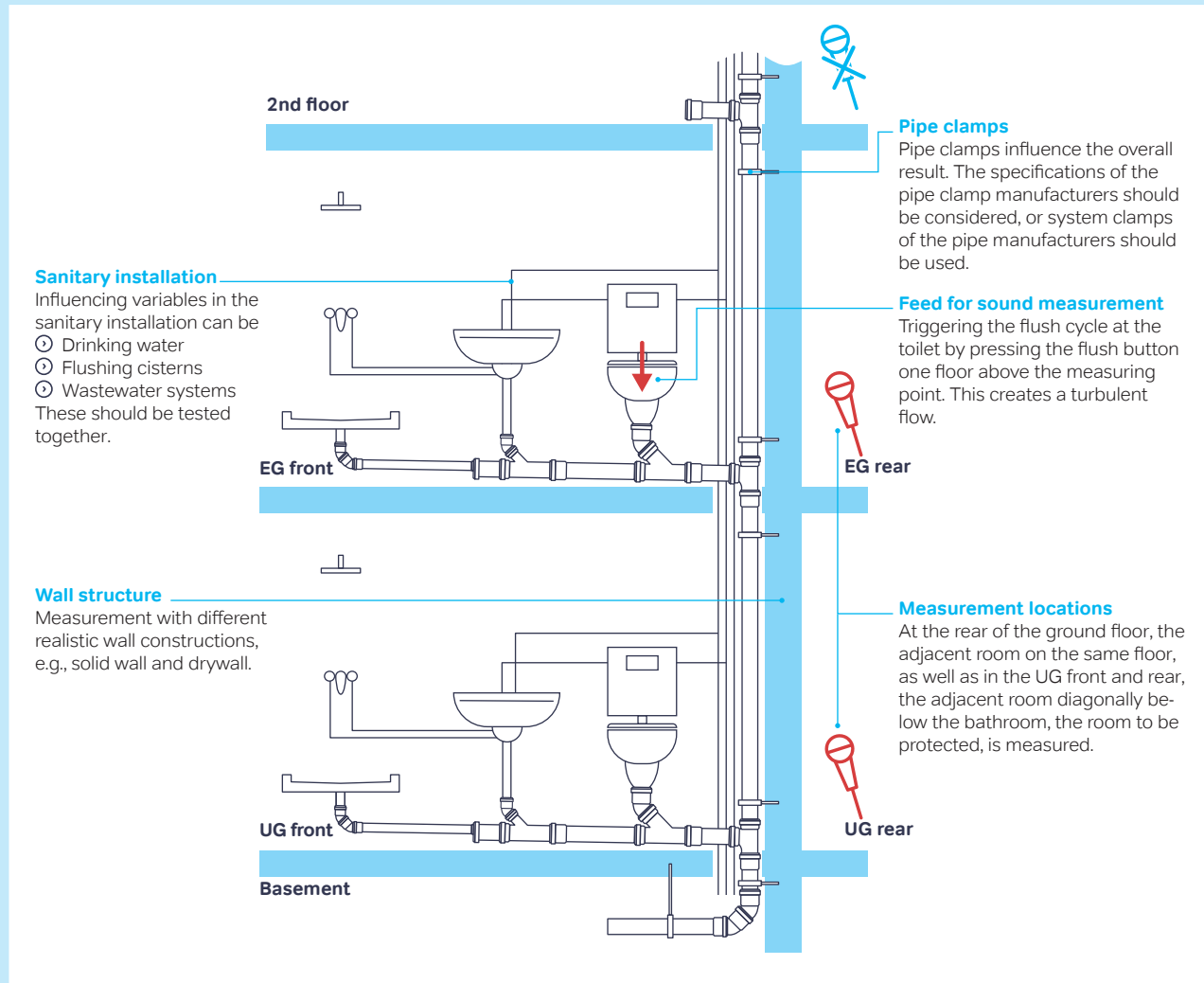

Figure 9: Representative setup for a measurement under real conditions.



# Compact sound insulation knowledge for architects

Unwanted noise can be reduced in the design phase of a building by observing the following points.

## Floor plan

Sound problems are significantly reduced with proper floor plan design. Kitchens and bathrooms should be planned next to each other and, in the case of apartments, on top of each other. Pipework does not belong on walls adjacent to bedrooms or other quiet living areas.

## Solid construction sample installation wall

Solid walls are some of the most frequently used walls for the installation of sanitary objects, as well as for fixing the water supply and drainage systems. It is possible to build according to DIN 4109-1 under certain conditions without further building acoustics testing. This is described in the chapter "Architecture". (Source no. 7)



No further sound insulation verifications are required if a sample installation wall is built.

## Lightweight sample installation wall

Lightweight walls with wastewater installations, drinking water installations or sanitary equipment can also be used according to DIN 4109-1 without further building acoustics testing. They must be built like a lightweight sample installation wall for this. We will explain more about this in the chapter on architecture. (Source no. 7)

## Single-shell building parts

Single-shell building parts consist of a consistent material or of several bonded layers of different materials with varying acoustic properties, such as masonry with plaster layers. One example for this is masonry with plaster layers. The heavier a single-shell building part is, the better its sound insulation properties.

## Multi-shell building parts

Multi-shell building parts consist of several flexurally rigid or flexible shells that are resiliently connected to each other. A vibration system with a resonant frequency is created in the building parts.

## Compact sound insulation knowledge for planners

### Planning of supply and disposal systems

The foundations for good building acoustics and optimum sanitary sound insulation are laid with careful planning of water supply and drainage systems.

Reference solutions can be used since not every situation on the building site has a separate building acoustics certificate available. These values help in the acoustic consideration and evaluation of the building situation.

The noise generated by drinking water and wastewater installations is always transmitted to the installation wall via fixed connections (e.g., pipe with pipe clamp). This structure-borne sound subsequently propagates and is radiated in other rooms on walls and ceilings as airborne sound.

Consistent sound decoupling between building parts and the building structure is required to effectively prevent these structure-borne sound bridges. This must be considered in the planning.

### Planning of the sewage system

Wastewater systems comprise various building parts. These include pipes, moulded parts, fasteners, materials for damping structure-borne sound and for damping airborne sound in a pipe.

Wastewater systems should be planned with care from a building acoustics point of view. Good floor planning considers, for example, that rooms to be protected do not adjoin walls where sanitary installation and pipework are fixed.

The changes in direction must be planned precisely when designing the wastewater pipe: 90° changes with bends should be avoided. Structure-borne sound insulation measures are necessary in the area of penetrations on walls and ceilings.



## Planning of drinking water installations

Fittings, drinking water pipes, drinking water heaters, pressure boosting systems, circulation pumps, or water treatment systems are part of the drinking water installation.

First, the drinking water pipe must be designed properly. For example, a flow velocity that is set too high can lead to interference noise. If the drinking water system is designed properly the noise from tap valves and toilet system will become lead source of noise.

Decoupling the pipework from the building structure is one of the most important sound insulation measures, even for drinking water installations. The main sources of noise are from fittings and transmission through the piping system, which is why compensating measures need to be taken.

Risers or stacks should not be connected to partition walls of rooms that must be protected.

The mass per unit area affects the structure-borne noise when the pipe is attached to structural elements. The greater the mass, the less vibrations of the pipe fastening are transmitted to the structural element. Ideal attachment points for the pipes to the walls are their more rigid areas. These include the edge areas of solid walls or the stud areas of lightweight walls. Alternatively, this can be done using a console on the ceiling.

## Supply and disposal systems and sanitary equipment

Supply and disposal systems also include sanitary equipment, such as sinks, toilets, or bathtubs and frames from which the curtain walls and installation shafts are built. The following items must be considered in the planning for this:

- ① Preventive fire protection, sound insulation, moisture protection, and thermal insulation must be considered during planning.
- ② Required slots or channels in the wall must not affect the structural stability. The mass in the wall still must be sufficient to meet the sound insulation requirements.
- ③ It is recommended to work with facing shells or curtain wall metal frame since an installation in a wall with slots usually leads to structure-borne sound bridges.
- ④ Sanitary objects such as toilets or washbasins must be fastened with structure-borne sound decoupling measures.

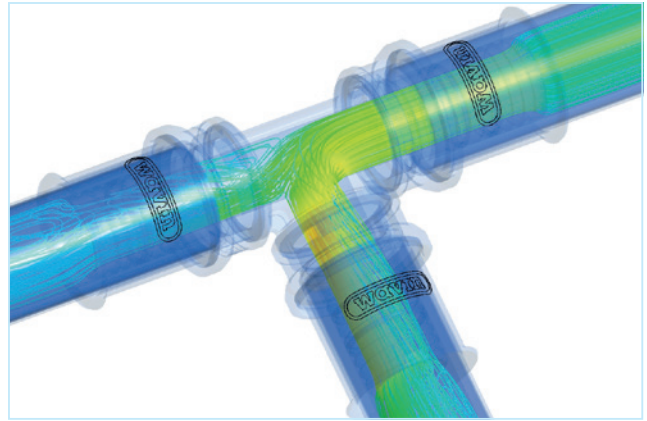

Figure 10: Flow conditions in a tee



Figure 11: Fastening to elements containing mass



Figure 12: Drywall walls with fastening via brackets to ceiling and floor





## Compact sound insulation knowledge for installers

Optimal sound insulation is dependent on professional installation. The following points describe the key influencing factors that installers should consider.

### Pipe system

During the complete installation of the pipes, it is crucial to avoid structure-borne noise bridges by decoupling them from the building structure. The choice of pipe system can already have a decisive influence on structure-borne sound transmission and airborne sound transmission. Wastewater pipes must not be laid freely in rooms to be protected from noise. If it is technically impossible to do otherwise, provide an insulated duct.

### Pipe clamps

Suitable structure-borne sound insulating pipe clamps are to be used for fastening the pipes.

If an unequal or unilateral load is applied to the pipe clamps, excessive compression of the elastomer will significantly reduce its acoustic performance.

When pipework is installed in ceilings and walls, it is necessary to decouple the pipe from the building structure to remove sound bridges. Penetrations must be sufficiently large and there must be no contact with the ceiling and wall. Insulation sleeves, mineral wool, or silicone are suitable for this.



# Architecture



## Architecture of soundproofed rooms.

To create spaces where people feel comfortable and where unwanted noise is minimised, good sound insulation is essential. This starts with the floor plan and ends with the right pipe system

Noise can be stressful and may lead to difficulty focussing. Sound insulation is becoming increasingly important and is now a priority for developers. People who live and work in well sound-insulated buildings are much more rested, alert and healthy.

Sound insulation must be an architectural consideration as well as a topic for planners and installers. Achieving the desired building aesthetics should not compromise sound insulation. Even the open room design and sophisticated geometries with complex sound reflections can be well insulated against noise today.

## Design basics for optimal sound insulation

### Beautiful sound or annoying noise?

What actually happens physically when a person perceives a tone, or harmonic sound, or a noise? If the audio signal oscillates uniformly and evenly, a tone will result. Tones from several frequencies that overlap evenly and in whole numbers form a sound. Otherwise, it will be a noise the human brain perceives as annoying.

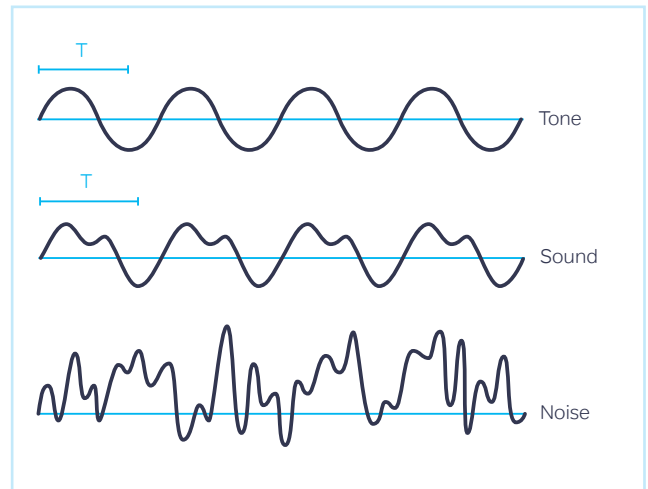

Figure 13: Tone – Sound – Noise

### Architecture can reduce unwanted noise

It is possible to keep external noise away from interior spaces, including living areas, by optimising and cleverly planning the building in terms of acoustics. The insulation of windows and exterior walls provides a tight acoustic envelope for the building. Consequently, low noises from water supply and drainage systems can suddenly become perceptible and disturbing:

- ⌚ In multiple occupancy buildings such as a hotel, where a toilet is flushed in an adjoining room, this may be a toilet being flushed next door,
- ⌚ or the sound of a drinking water pipe not laid optimally or incorrectly designed

⌚ A knocking sound from the heating or drinking water pipes. These issues are barely noticeable in old and poorly sound-insulated buildings, where external ambient noise is perceived as louder, overriding the noise levels from internal rooms. In new construction, however, the architect must find answers to these questions:

- ⌚ Which rooms need to be protected, and how can they best be acoustically protected?
- ⌚ Where will the manhole for the main drainage and drinking water supply be placed?
- ⌚ In what quality and mass is the installation wall built?
- ⌚ How can the acoustic regulations of different countries be met?



### Consulting and training during the design phase

The right products should be selected and manufacturers should be consulted even before the construction phase. Wavin advises architects on how best to consider sound insulation and also offers technical training on the subject. This enables architects to

avoid mistakes as early as the design phase of the building.

The basic parameters should be defined at an early stage. This will then make it easier for planners and installers during the course of the project.

## Building classes in Germany

There are different requirements for acoustics and fire protection requirements, as well as different standards depending on the building class:



### Building class 1

Free-standing buildings with a height of up to 7 m and no more than two units of use totalling no more than 400 m<sup>2</sup>, as well as free-standing buildings used for agriculture or forestry.



### Building class 2

Non-detached buildings with a height of up to 7 m and no more than two units of use totalling no more than 400 m<sup>2</sup>.



### Building class 3

Other buildings with a height of up to 7 m.



### Building class 4

Buildings with a height of up to 13 m and units with no more than 400 m<sup>2</sup> each.



### Building class 5

Other buildings, including underground buildings



### Special constructions

All buildings that do not fall into the building class 1-5 are special buildings

§ RULES	CHARACTERISTIC VALUES FOR									SOUND INSULATION AGAINST NOISE FROM			
	Exterior components	Apartment buildings	Single family semi-detached and terraced house	Dedicated living area	Office building	Mixed uses	Hotels and lodging	Hospitals and sanatoriums	Schools and similar facilities	Restaurants and bowling alleys	Particularly loud rooms	Building services Facilities	Connected operation
DIN 4109-1	X	X	X	X	X	X	X	X	X		X	X	
DIN 4109-5		X	X			X	X	X				X	X
DIN SPEC 91314		X	X		X							X	X
VDI 4100	X	X	X	X								X	
DEGA 103	X	X <sup>1)</sup>		X						X		X	X
DEGA 104				X								X	
VDI 2569	X				X						X		
VDI 3726	X <sup>2)</sup>									X		X	

Table 1: Overview of the areas of validity of the various sets of rules (source no. 6)

<sup>1)</sup> The term of accommodation unit is used across the board.

<sup>2)</sup> Outdoor noise is covered as far as it penetrates outdoors from restaurants and bowling alleys.

# The quietest place in the world

**-20.6 dB**



99.99 percent of the noise is absorbed.

## **Echo-free chamber**

A regular conversation is about 60 decibels loud. There are still around 30 decibels around us at night, when we sleep. That's quite a racket compared to an anechoic chamber, as can be found in Microsoft Audio Labs: This room is so well insulated that it is the quietest place in the world at -20.6 decibels. An almost eerie silence.

## Increased sound insulation in hotel rooms

Guests at the hotel want their rooms to be comfortable, quiet, and relaxing above all. Room acoustics play a particularly important role here in architecture. DIN 4109 also specifies minimum requirements for lodging establishments. However, the guests' need for quiet is usually higher than this prescribed sound insulation. Therefore, a sound reduction index of 53 dB applies in the architecture of hotel buildings, corresponding to the value for partition walls in living rooms.

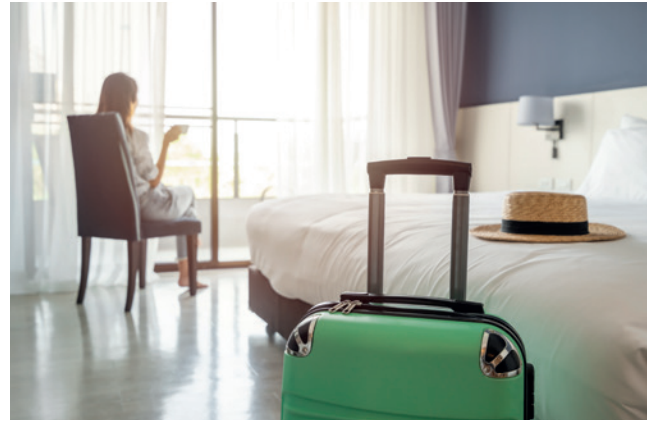

### Sound insulation in architecture – to be considered in the design and layout:

- 01** Avoiding open floor plans to achieve good sound insulation in the living area
- 02** Using curtain or partition walls for maximum freedom of design.  
This achieves excellent room acoustics even with unfavourable floor plans.
- 03** Whether solid house or timber frame construction: There is a sound insulation solution for any option. However, one thing always applies: A large mass is essential for reducing structure sound transmission. Thus, the relevant walls should be built up solidly.
- 04** The building services installation that is routed through use duct should be located in places that result in the least disturbance to the user. A shaft directly adjacent to rooms to be protected is unfavourable.

## Interaction between acoustically favourable construction and sanitary installation technology

The most modern acoustic rated products alone will not be enough to achieve good sound insulation in the building. The appropriate building technology must be chosen as well – with acoustically favourable floor plans, ceiling and wall constructions. Only the duo of construction technology and sanitary installation can achieve the required sound insulation for the buildings.

# The components for optimum sound insulation

## Room layout/floor plan

Sound insulation starts with the floor plan. Rooms where potable water/drainage noise occurs should be located adjacent to or on top of each other. The latter for apartment buildings, multi-story residential construction and hotel buildings. Pipes naturally should not run through walls that border bedrooms.

## Installation walls

A building acoustics test in accordance with DIN 4109 is not vital if your installation walls meet certain requirements.

## Single-shell solid installation walls

A single-shell solid installation wall must be planned and executed as a "single-shell solid construction sample installation wall" for this. Section 6.4.4.2.2 of DIN 4109-36 applies here. Such an installation wall must have a mass per unit area of at least 220 kg/m<sup>2</sup>. The provisions of sections 6.4.4.2.3 to 6.4.4.2.5 of DIN 4109-36 must be met for the installation-technical and structural boundary conditions. (Source no. 7)



Figure 14: Example of the creation of a cantilever

## Lightweight walls

Lightweight walls can also be used as installation walls without further building acoustics testing. They must meet the conditions of a "lightweight sample installation wall" in accordance with Section 6.4.4.3.2 of DIN 4109-36 for this purpose. Sections 6.4.4.3.3 to 6.4.4.3.5 apply to the structural and installation-technical boundary conditions. (Source no. 7)



More about the sample installation walls can be found in the "Planning" chapter starting on page 35.

## Pipe system and mounting

Homeowners usually don't put much emphasis on the selection of the drainage system to be installed in their building. Customer focus tends to be on interior finishes such as tile, kitchen, etc. Architects need to be aware that the sound emission values of a pipe system, once installed, cannot be easily improved. Manufacturers advise on the choice of the right sound insulation pipe system, including mounting clamps and branches with an inner radius. These choices have a major influence on the future transmission of structure-borne and airborne sound.

Bridges for structure-borne sound are avoided when the pipes are installed properly and professionally. This is achieved by decoupling the lines from the building structure. Wastewater pipes must not be laid freely in rooms to be protected. If it isn't possible any other way, plan for a duct with adequate insulation.



## Virtual noise measurement with the Wavin SoundCheck tool

Noise regulations are routinely updated and it is not always easy to calculate the correct noise level for a specific architectural design. The online tool Wavin SoundCheck takes care of this task. The tool simulates and calculates the system acoustics of the installation based on individual parameters. You can find out in just a few steps whether the design meets the sound insulation requirements.



Try the Wavin SoundCheck tool right now!



<https://bit.ly/3RZuO2D>



## Practical advice:

"I learned early on how important it is to think ahead in my professional practice. One can avoid many things that would get really expensive later on particularly in the early stages of a building project, with the first design thoughts. Sound insulation is one of them. This starts with the floor plan and does not stop with the positioning of utility shafts. I want to design comfort zones for my clients. Annoying noises are not part of it. However, this cannot be done without a technical understanding of how sound and sound bridges are created.

My advice: Coordinate with experienced planners as early as possible and also get a manufacturer on board who can provide comprehensive advice on the subject of sound insulation in the area of wastewater and drinking water – and who has the appropriate solutions in stock."

Christina M., architect



### Practical advice

- ① Open floor plans are a risk for good sound insulation, as areas with water-bearing pipes often merge into living areas without separating walls. Therefore, for sound insulation reasons, make sure that rooms used for different purposes are well separated.
- ① Curtain or partition walls will help you achieve optimal room acoustics. At the same time, they give maximum design freedom even for challenging floor plans.
- ① Build soundproofed walls with as much mass as possible. The greater the mass, the less structure-borne sound will be transmitted.
- ① The building services installation through shafts should not be located directly on protected rooms.



### Interfaces

- ① You can create a floor plan that minimises airborne and structure-borne noise from the very beginning together with a planning office.
- ① When planning the water supply and drainage systems, there are many important tips in the planning chapter of this brochure.



### Attention!

Different countries have different limits for sound insulation and acoustics. If you are involved in international construction projects, get advice on this – from the Wavin experts, for example.



### Legal matters

- ① Observe the different normative and legal requirements for acoustics and fire protection depending on the building class.
- ① Section 6.4.4.2.2 of DIN 4109-36 applies to single-shell solid installation walls. Sections 6.4.4.2.3 to 6.4.4.2.5 apply to the installation-technical and structural boundary conditions.
- ① Section 6.4.4.3.2 of DIN 4109-36 applies to lightweight walls used as installation walls. Sections 6.4.4.3.3 to 6.4.4.3.5 apply to the structural and installation-technical boundary conditions.

# Planning



# Planning water supply and drainage systems. For optimised acoustics.

When planning the water supply and drainage systems, it is important to keep unwanted noise to a minimum. Supply and disposal systems in real estate are mostly covered in terms of plumbing and installation walls.

Reference solutions (for example, sample installation walls) can be used as a guide when planning the water supply and drainage pipework since there is not a separate building acoustics certificate for every situation on the building site. These values help in the acoustic evaluation of the building.

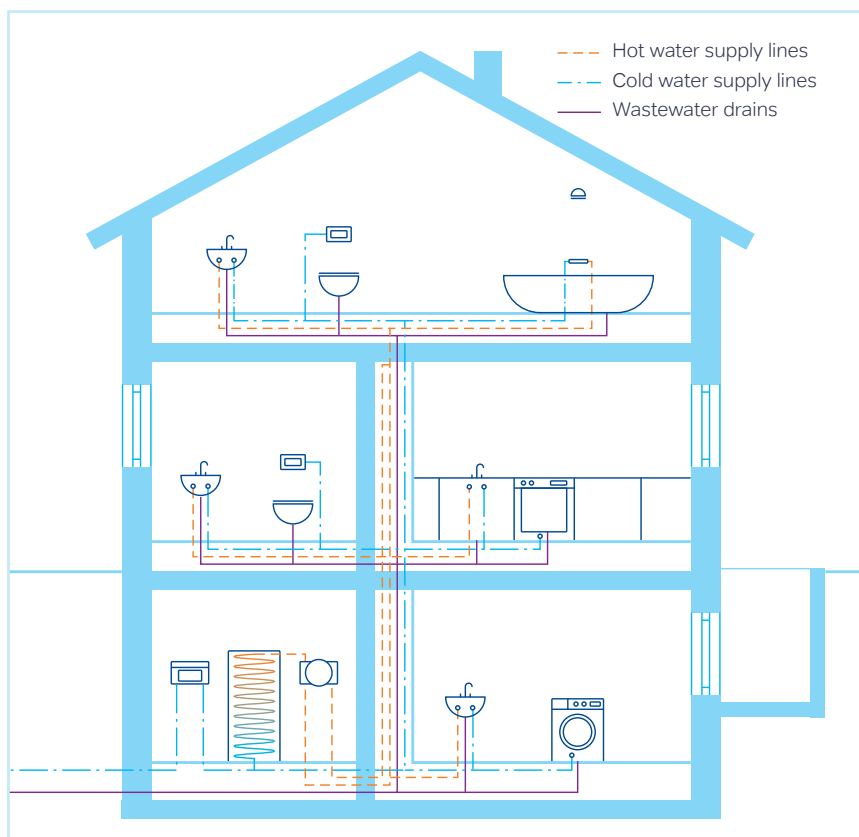

**Figure 15:** Supply and disposal lines in a building

# Basics of planning supply and disposal lines

## Structure-borne sound

The interfering noise generated by drinking water and wastewater installations is always transmitted to the installation wall via hard connections (e.g., pipe with pipe clamp).

 This structure-borne sound subsequently propagates and is radiated in other rooms on walls and ceilings as airborne sound.

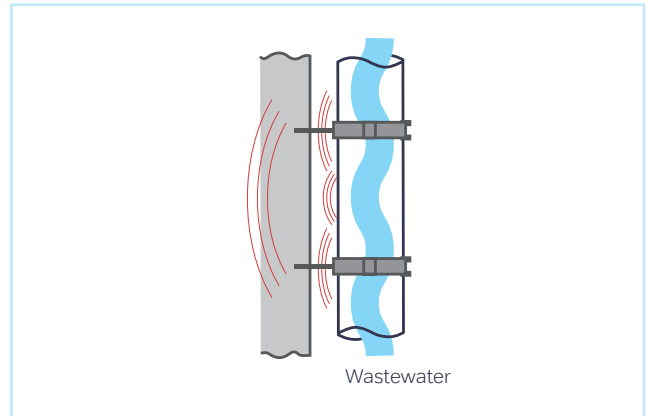



Figure 16: Structure-borne sound

## Airborne sound

The airborne sound transmission of a pipe system depends mainly on the quality of the pipe. If pipes are to be compared, this is easily possible according to DIN EN 14366, as the pure airborne sound transmission is also measured here. For a complete consideration of the system, however, the pipe bracket and its fastening are also very important. So airborne sound and structure-borne sound are two important factors.

 See also chapter "System testing according to DIN 4109", page 54

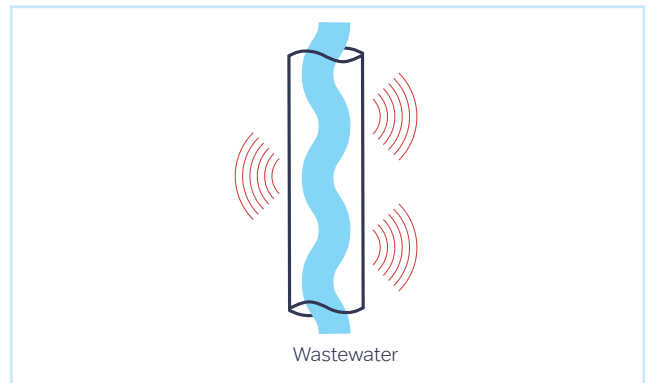

Figure 17: Airborne sound

**Airborne sound is created from structure-borne sound here:**

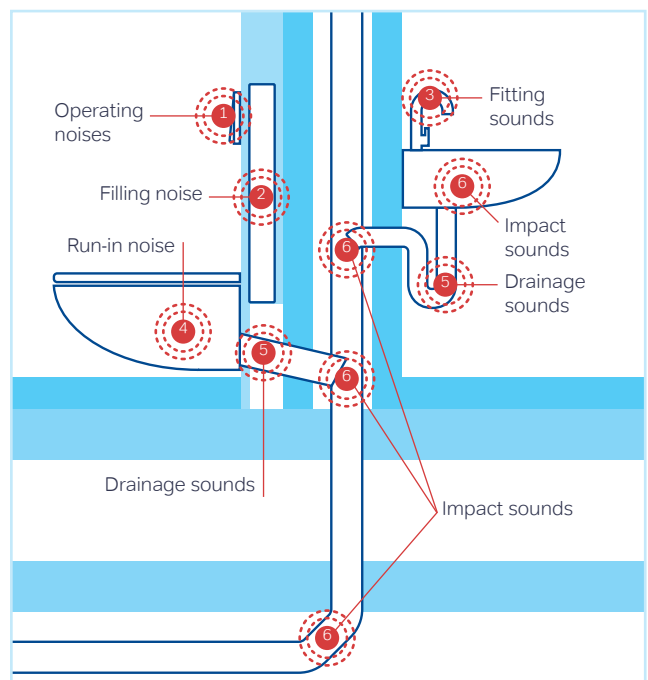

Figure 18: Noise sources in drinking water and wastewater installations

### Structure-borne sound bridges

To prevent structure-borne sound bridges, appliances (e.g. toilets) need to be decoupled from the building structure to prevent sound bridges. This must be considered in the planning. (Source no. 6)



## DIN 4109

The following aspects are important during planning and execution to achieve the minimum requirements according to DIN 4109:

- ① Which installation walls with what texture are selected?
- ① Where in the building are the bathrooms and where are the rooms to be protected?
- ① What wastewater and what drinking water pipe systems should be used?
- ① How are the pipe systems fixed?
- ① Which noise compensation measures (e.g., pipe sound insulation or duct) are suitable?

## Floor plan

Potential sound problems are significantly reduced with proper floor plan design. For example, kitchens and bathrooms with their water supply and drainage pipework should always be planned next to each other, or in the case of apartments, on top of each other. Walls directly adjacent to rooms to be protected should not contain pipework. (Source no. 6)

**Bathroom and kitchen on a common installation wall**

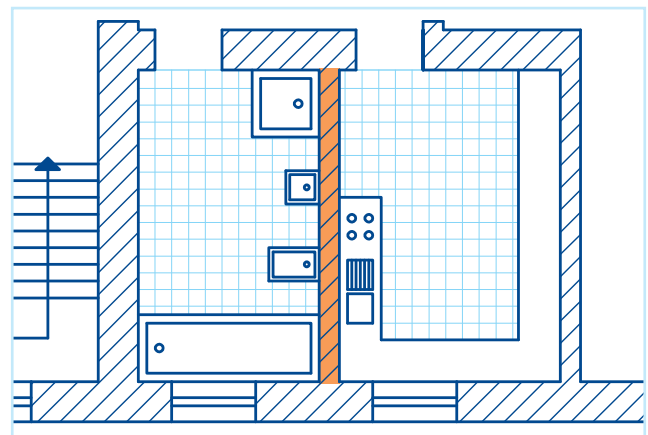

**Bathrooms and kitchens on common installation walls**

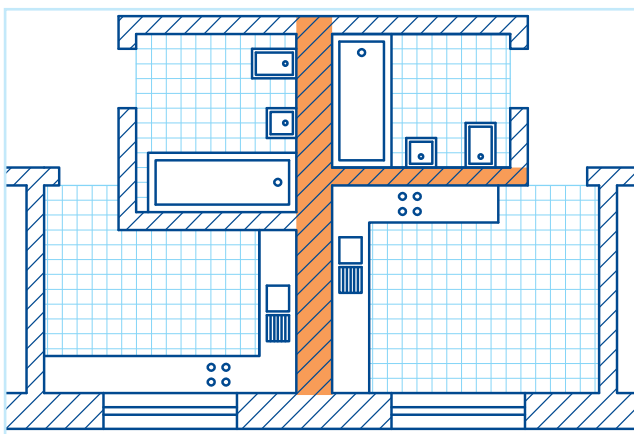

**Bathroom, kitchen, and toilet the same installation shaft**

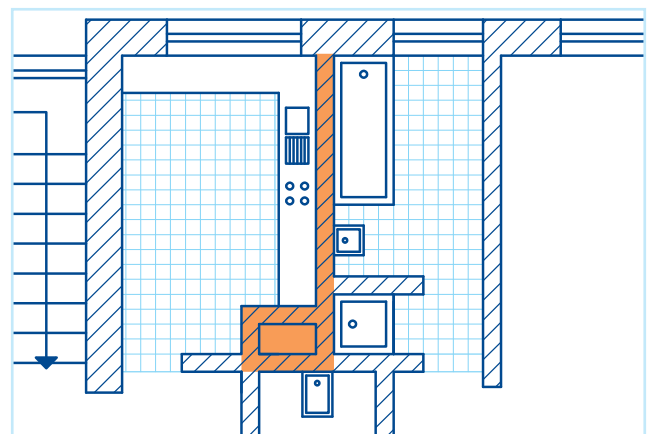

The Wavin SoundCheck tool can be used to compare different shaft materials in order to achieve ideal sound attenuation or to avoid sound reflections (see also page 11).



## Mistakes in planning of water supply and drainage pipework have consequences

Drainage sounds are a frequent reason for bad reviews in hotels, for example:



"Loud water and sewage noises from the adjacent apartment ruined our stay."



"Noise pollution due to loud water pipes – don't book here!"



"Loud banging noises from water pipes coming out of the wall kept me awake since 5 AM"



## Planning the penetrations in ceilings and walls

It is important that the penetrations are sufficiently large and there is not any contact between the pipework and wall or ceiling which could create a sound bridge. Insulation sleeves, mineral wool, or silicone can be used for this purpose. Sound decoupling must be installed in a right way and a sound bridge must be prevented during the installation.

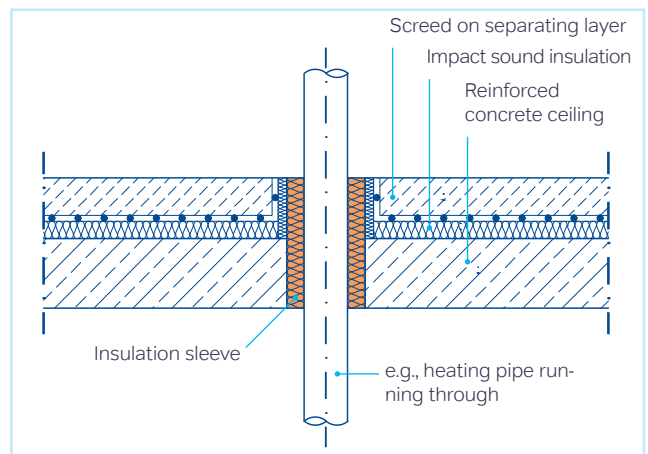

Figure 19: Pipe feedthrough without sound bridge



A sound bridge can be, for example, building debris that creates a structure-borne sound bridge. Installation errors can be another cause, e.g., a forgotten structure-borne sound decoupling.



Figure 20: Forgotten structure-borne sound decoupling



Figure 21: Building debris as a structure-borne sound bridge

# The loudest water in the world



40 km

far, the waters of Augrabies Falls, South Africa, can be heard on still nights.

## **Augrabies Falls, South Africa**

The name is derived from the South African term of "Aukoer-ebis" – "place of thunderous noise". This waterfall is aptly named since it is probably the loudest one there is. Its sound is amplified by the barren, flat walls of the canyon.

# Floorplan design

A complete drainage system comprises pipe and fittings, brackets and materials for damping structure-borne and airborne sound.

A good floor plan is the starting point for optimal sound insulation: Rooms to be protected (Flat B), for example, should not border any walls where installations are located on the other side or where wastewater pipes are installed.

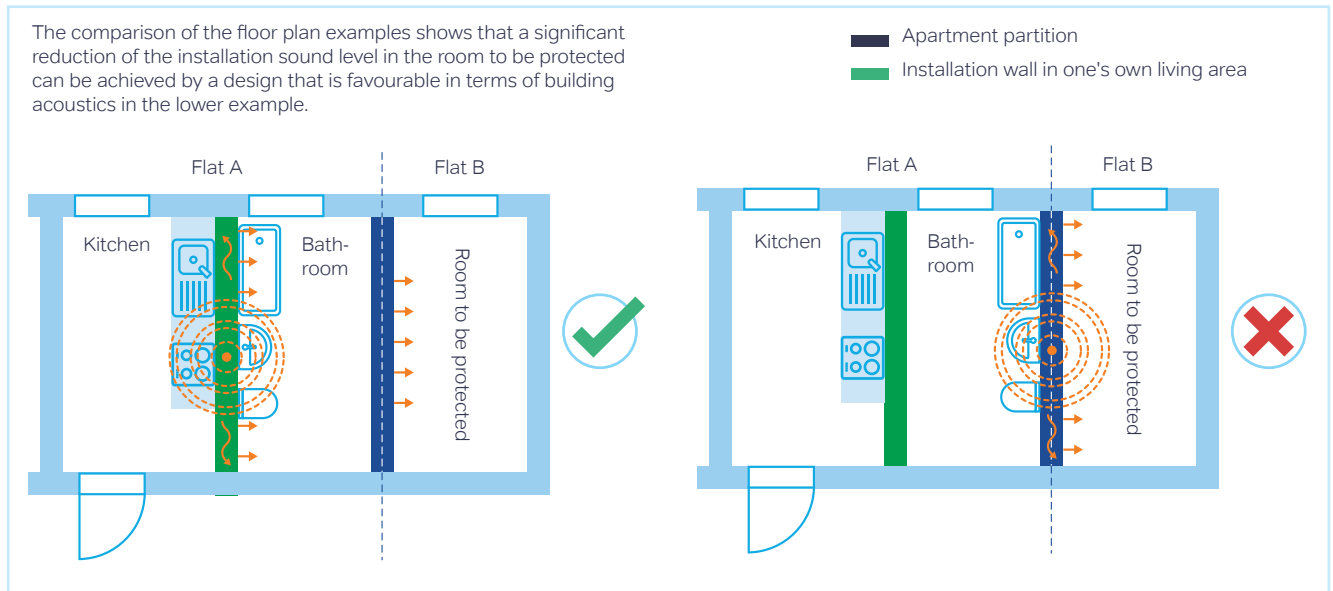

**Figure 22:** A floor plan favourable from the point of view of building acoustics

## Installation wall

If the specific mass of the installation wall changes, the reference sound pressure level at 220 kg/m<sup>2</sup> also changes. Thus, for an installation wall of 160 kg/m<sup>2</sup>, the result would differ by about 2.5 dB(A) compared to a 220 kg/m<sup>2</sup> wall.

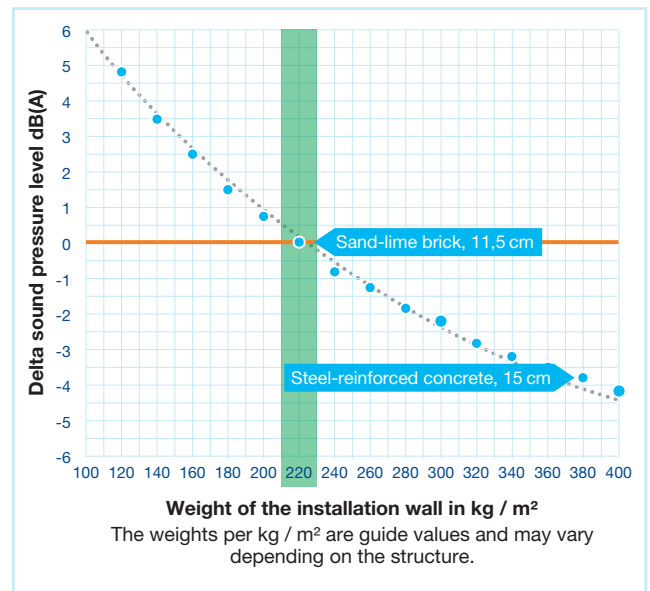

**Figure 23:** Illustration of the change in sound pressure level in the adjacent room as a function of different wall materials from Wavin SoundCheck.



## Advance wall construction

In the case of a lighter installation wall, or if the room to be protected is located on the opposite side, use facing shells in the design. They comprise a substructure made of metal, which is planked with panels. The cavity in the substructure is filled with insulation materials and support stands for sanitary objects. Such facing shells significantly improve sound and also heat insulation.

A curtain wall system improves the damping of the entire building structure even in solid walls.



**Figure 24:** Advance wall construction in front of a solid wall (source: Knauf)



### Planning of wastewater pipes

Special attention should be paid to changes in direction when designing wastewater pipes. 90° changes are to be avoided. This is possible, for example, by using 2x 45° bends.

The choice of a specialist insulated, low-noise and easy-to-install pipe system (pipes, bends, wall ducts, mounting clamps) is crucial for minimising the transmission of structure-borne and airborne noise here.

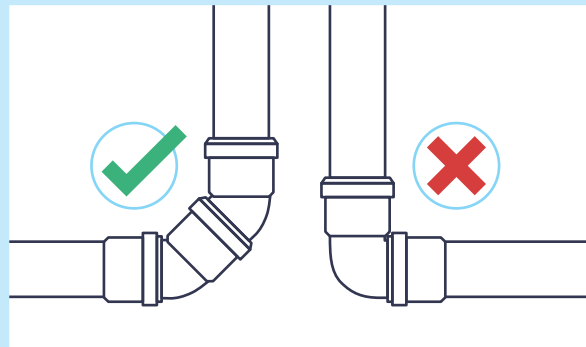

**Figure 25:** Installation situation with different bends



### 5 pieces of practical advice for avoiding sound bridges in the planning.

- 01** Fastening to heavy building parts or in facing shells
- 02** Ensure proper fastening with structure-borne sound decoupling
- 03** Avoid sharp changes of direction
- 04** Where channel for wastewater pipe are used, the residual wall must still have 220 kg/m<sup>2</sup>
- 05** Sanitary objects must be decoupled



## Consider fire protection

Sound insulation measures must also be observed when considering fire protection for the building class.

Here, Wavin offers a fire protection collar for all Wavin drainage pipes and installation pipes. These seal the wall or ceiling penetration in the event of a fire and prevent fire, smoke, or gas from spreading.

## Planning of drinking water installations

Potable water pipe and fittings, water heaters, pressure boosting systems, circulation pumps, or water treatment systems comprise a full system.

The most important thing where sound insulation is concerned is the correct design of the drinking water pipe. The main sources of noise are fittings and transmission through the piping system. If too high a flow rate is selected, this can lead to interference noise. The valve noise overlap if the design is correct.



The flow velocity must not exceed 2 m/s in the building connection line; in consumption lines, it can be up to 4 m/s, depending on the continuous consumer and the resistance coefficients of shut-off valves.

The most important sound insulation measure in the planning of drinking water installations is also here a decoupling from the building structure at wall and ceiling penetrations. Suitable compensation measures must be selected here:

- ② Valve connection with integrated structure-borne sound decoupling
- ② Pipe clamps with insulation insert
- ② Wall panels with an acoustic hood
- ② Never connect any risers and equipment connection lines to partition walls of rooms to be protected

The heavier the mass of the wall, the less the transmission of structure-borne sound through the pipe and its attachment can cause the wall to vibrate. Always use the stiffer building parts for mounting to avoid vibration with drywall. Solid walls are stiffer at the edges and can therefore vibrate less.

## Installation systems and sanitary objects

Specific planning rules apply to curtain wall installations, in-wall installations, metal frames, installation shafts or ducts, wash-basins, bathtubs, toilets, bidets, urinals and sanitary fittings. The following rules should also be considered:

- ② Preventive fire protection, sound insulation, moisture protection and thermal insulation.
- ② If channels in the wall are necessary, the statics must not be compromised. The mass the wall must be sufficient to meet the sound insulation requirements.
- ② Instead of installation in the wall with slots, facing shells or curtain wall metal frame are recommended to avoid structure-borne sound bridges.
- ② Sanitary objects such as toilets must be suspended with structure-borne sound decoupling while avoiding any effect on structural properties.

### Soundproofing components for toilets

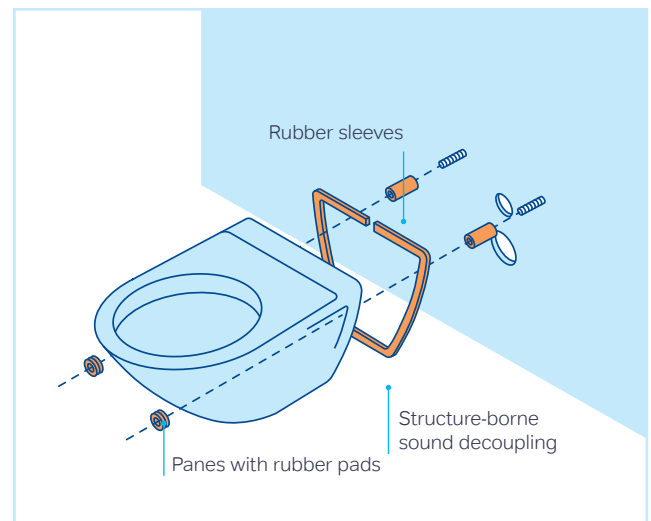

**Figure 26:** Design of a wall hung toilet system without sound bridges

## Design of a solid construction sample installation wall

Solid walls with potable water or drainage installations or sanitary objects must meet these conditions according to DIN 4109-1 without further building acoustics testing:

- ⊙ The single-shell solid wall has a mass per unit area of  $\geq 220 \text{ kg/m}^2$ , under consideration of plaster layers.
- ⊙ Fittings and devices meet the requirements of DIN 4109-1.
- ⊙ The pressure of the drinking water installation at rest upstream of the fittings after distribution in the floors does not exceed 0.5 MPa; a higher pressure must be reduced by installing pressure reducers.
- ⊙ Through valves are always fully open during operation.
- ⊙ Fittings in operation do not exceed the flow rate on which their classification is based.
- ⊙ Outlet devices must limit the flow through the fitting accordingly. As a result, they must not belong to a higher flow class than the associated valve outlet.
- ⊙ Potable water and drainage pipe are soundproofed in front of the wall.
- ⊙ Structure-borne sound insulating sheathing must be used for the installation of drinking water and wastewater pipes in wall slots.
- ⊙ Wastewater pipes on walls of rooms to be protected are not exposed.
- ⊙ The installation system in the curtain wall and in front of the solid wall with structure-borne sound decoupling from the building structure.
- ⊙ Pipes on solid installation walls or on separate supporting elements connected to the wall are decoupled and fastened with pipe clamps with insulation insert. Direct attachment to the wall is not permitted.
- ⊙ Penetrations of pipes and fittings through solid walls are designed in such a way that structure-borne sound transmission is avoided.
- ⊙ Sanitary objects on the installation wall are fixed sound-proof.
- ⊙ Fittings of fittings group I and their water pipes, wastewater pipe, and sanitary objects are installed on solid walls with  $\geq 220 \text{ kg/m}^2$ .
- ⊙ Fittings of fitting group II and their water pipes, wastewater pipes, and sanitary objects without special proof may not be installed on walls adjoining rooms to be protected. (Source nos. 6 and 7)

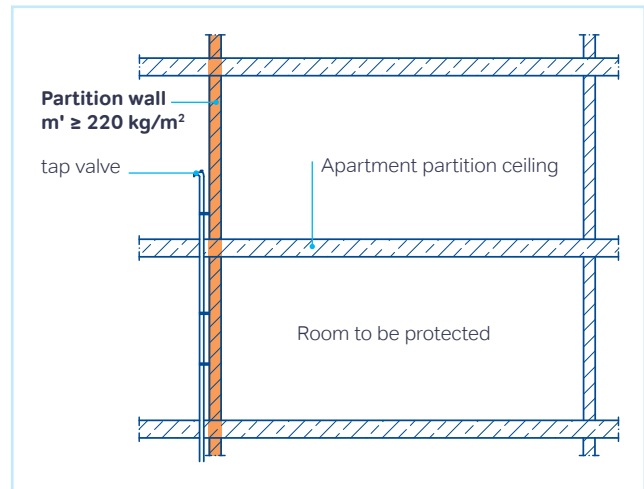

Figure 27: Arrangement of fittings of fitting group I

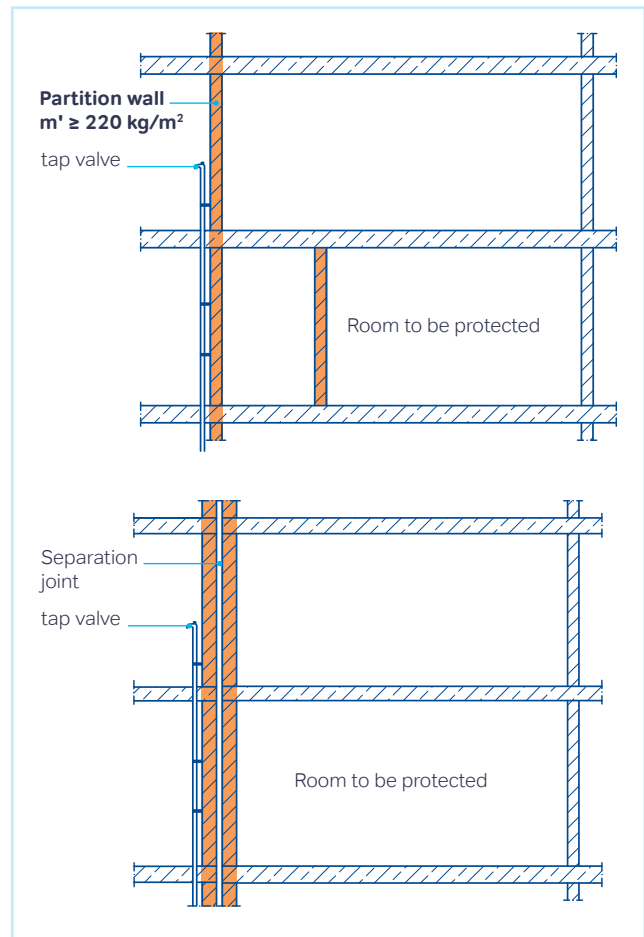
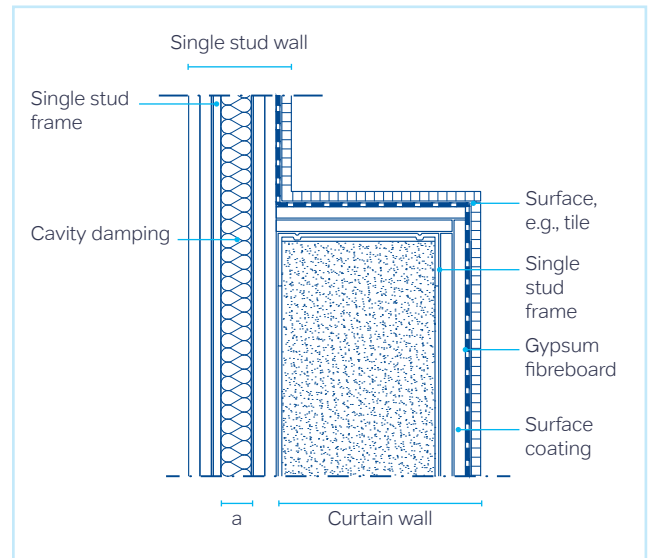

Figure 28: Arrangement of fittings of fitting group II

## Design of a light-weight sample installation wall

Light-weight walls to which or in which wastewater installations, drinking water installations or sanitary objects are attached must meet these conditions according to DIN 4109-1 without further building acoustics testing:

- ① The verification based on the lightweight sample installation wall is only permissible if the area-related mass of the ceiling is  $\geq 450 \text{ kg/m}^2$  and fittings of fitting group I are used.
- ① The light-weight sample installation wall is a wall made of plasterboards with metal substructures with the following superstructures:
  - Single stud wall with additional curtain wall installation
  - Double stud wall with additional curtain wall installation
  - Double stud wall with internal sanitary installation
- ① The following boundary conditions apply for stud walls with additional curtain wall installation:
  - at least one two-layer planking per side made of 12.5 mm plasterboard or gypsum fibreboard with a mass per unit area of  $\geq 11 \text{ kg/m}^2$  per layer of boards
  - a distance of the planking  $a \geq 75 \text{ mm}$  (cavity thickness)
  - a cavity damping with 60 mm thick fibre insulation material with a length-specific flow resistance of  $\geq 5 \text{ kPa s/m}^2$
- ① At least a two-layer planking of 12.5 mm plasterboard or gypsum fibreboard with  $\geq 11 \text{ kg/m}^2$  per board layer and cavity damping must be provided for the additional curtain wall installation.
- ① Contact points of the substructure of the curtain wall installation to the building structure are to be designed, for example, with connection seals and structure-borne sound decoupling.
- ① The following applies to a double stud wall with internal sanitary installation:
  - The CW stud profiles of the two sides of the wall can be connected to each other with plasterboard strips or sheet metal profiles at 1/3 and 2/3 of the height of the wall by means of tabs to provide tensile and compression strength
  - Pipes and pipe clamps shall be attached to a separate substructure of stud sections installed free-standing and without contact with the planking shells or tabs in the cavity. (Source nos. 6 and 7)



**Figure 29:** Single stud wall with additional curtain wall installation

## Solid construction

The walls and curtain walls are made of masonry blocks, concrete, or reinforced concrete in solid construction. The mounting elements are attached to the installation wall for the design of curtain walls in solid construction. The element itself has virtually no static function. Therefore, the curtain wall must absorb the acting forces. This option is susceptible to structure-borne sound bridges and is therefore rarely installed anymore.

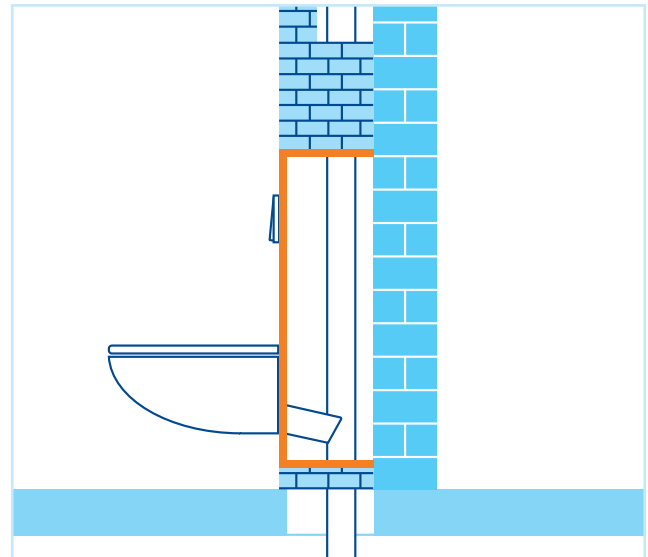

**Figure 30:** Walling off in wet construction in front of solid wall (based on source 8)

## Drywall curtain wall in front of a solid installation wall

Here, a curtain wall profile is attached to the solid installation wall in as decoupled a manner as possible. It is also important that the installed plasterboard and mounting elements are not in contact with the masonry, so that structure-borne sound bridges are avoided. The sanitary ceramics are also hung decoupled.

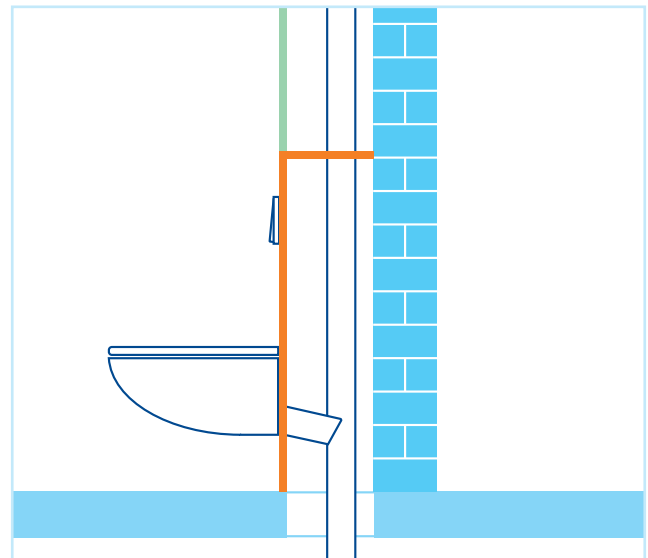
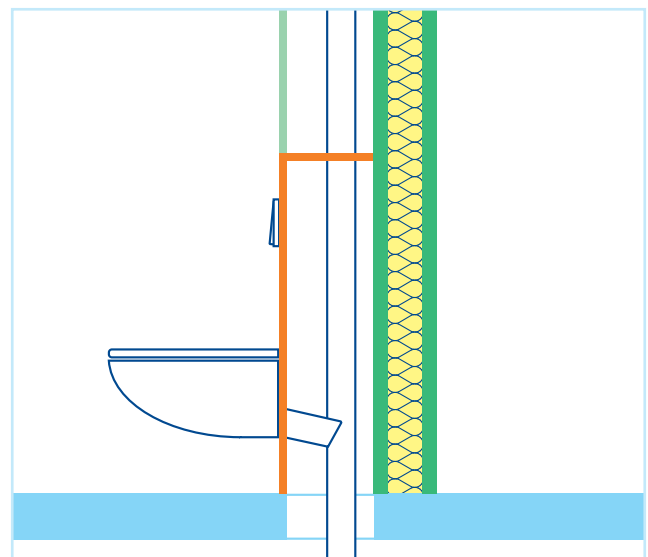

**Figure 31:** Drywall curtain wall in front of solid wall (based on source 8)

## Drywall curtain wall in front of a drywall

Drywall construction uses lightweight walls with a significantly lower weight per unit area than solid walls. Mounting elements are attached to their stud structure and the whole is covered with plasterboard panels.

Experience has shown that the sound insulation requirements can best be met when the entire curtain wall installation, with sanitary objects, is fitted by the same installer.



**Figure 32:** Curtain wall installation in front of a drywall panel (based on source 8)

## Partition wall

A partition wall can be used for the planning of sanitary installations as well. The necessary cables are laid inside the partition wall, so it is necessary to consider a cavity in the wall.



More on "Reverberation time and sound absorption area" can be found in the chapter "Introduction" on page 11.

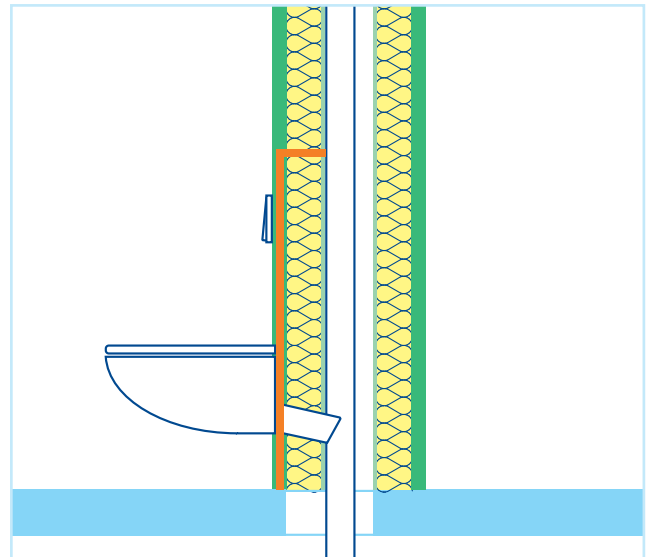

Figure 33: In-wall installation (based on source 8)



### Calculating noise. Simply with the Wavin SoundCheck tool

The Wavin SoundCheck tool simulates the system acoustics of the installation design based on individual parameters. Everything is calculated in no more than just four clearly defined steps. The results show whether the room plan meets the noise level requirements. This results in a valuable indication for the choice of material.

Try the Wavin SoundCheck tool right now!



Wavin  
SoundCheck



<https://bit.ly/3RZuO2D>

### More relaxed planning – with the 360-degree service by Wavin

- ⌚ All documents necessary for the planning of the water supply and drainage pipework will be provided by Wavin: Tender texts, data for the planning software, article numbers and the Fraunhofer IBP test reports with assessment of individual products and the entire system according to DIN EN 14366 and 4109.
- ⌚ Wavin's planning department provides advice at the design stage and supplies the complete sound insulation package to the trades performing the work.

## Practical advice:

"Planning construction projects is a calculation with many variables. This involves the client's wishes, the architect's ideas, the economic specifications and, last but not least, of course, fire protection, and sound insulation. Bringing all this together under one roof and doing justice to everyone is an exciting challenge.

It generally is helpful to sit down at the table with all those involved as early as possible and also to think about sound insulation from the very beginning. There is more to consider here than just DIN 4109. In hotel buildings, for example, every centimetre in the rooms counts. Bathroom and bedroom are often adjacent to each other – yet disturbing noise should be avoided.

Competent advice on such and other aspects is a good idea. The producers of sound insulation pipes are a good contact here."

Roland S., planner



### Practical advice

- ① Fasten water-bearing pipes to heavy building parts or facing shells.
- ① Brackets require structure-borne sound decoupling.
- ① Strong changes in direction lead to interference noise and must be avoided.
- ① Where slots for wastewater pipe are used, the residual wall must still have at least a mass of 220 kg/m<sup>2</sup>.
- ① Something that is often forgotten: Sanitary objects and supply and disposal lines must also be acoustically decoupled.



### Interfaces

- ① Coordinate with both the architect and the installer in the planning process.
- ① Architecture-related decisions relevant to sound insulation can be made at an early stage, as early as the floor plan planning stage, which will pay off later in the course of the project.
- ① Consider the requirements and needs of the installer on the job site. They are the ones who install the water supply and drainage pipework and all sanitary objects. Important details can be found in the installation chapter of this brochure.



### Attention!

Observe the flow velocity in the house connection line. This must not exceed 2 m/s. This may be up to 4 m/s in supply pipework inside the building.



### Legal matters

- ① The minimum requirements of DIN 4109 must be achieved in sound insulation planning and execution. The following are of particular relevance here:
  - The nature of the installation walls
  - Positioning of bathrooms and rooms to be protected in the building
  - Type of sewage and drinking water pipe systems
  - Attachment the pipe systems
  - Sound insulation compensation measures
- ① There are also some rulings that require an increased requirement already when the building is built to a higher standard. The correct choice and processing of the pipe system are particularly important because of this.

# Installation







## Installing optimal sound insulation.

Minimise noise from drinking water and wastewater installations.  
For satisfied builders, relaxed users – and a successful contract.

# The right choice of materials for best sound insulation

Installers can make the decision if the pipe material is not specified, and thus lay the foundation for good sound insulation.

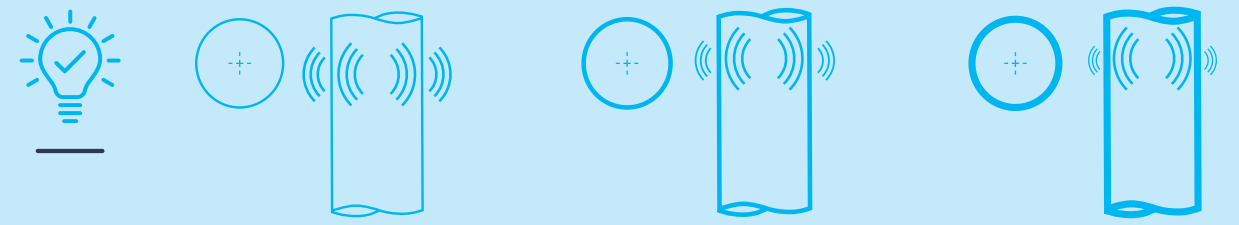

**Traditional pipe systems** are manufactured using PP or, in other markets, PVC-U. These systems have a small wall thickness and low density. These pipes only offer minimal protection from airborne and structure-borne sound.

Pipes in the medium specification range already differ from standard pipes due to their material formulation. They are made of PP and additionally mineral-reinforced. This makes the wall thickness of these pipes greater and the density higher.

Premium or high-specification pipe systems have increased density and wall thickness. A high weight per unit area is ensured with this mass and density, delivering best-in-class airborne and structure-borne sound performance.

## Selection of the right fittings

Installers need to select the potable drinking water carefully. Not all fittings are designed in the same way and it is important that a good flow is achieved with minimal resistance at the points where noise may be generated.

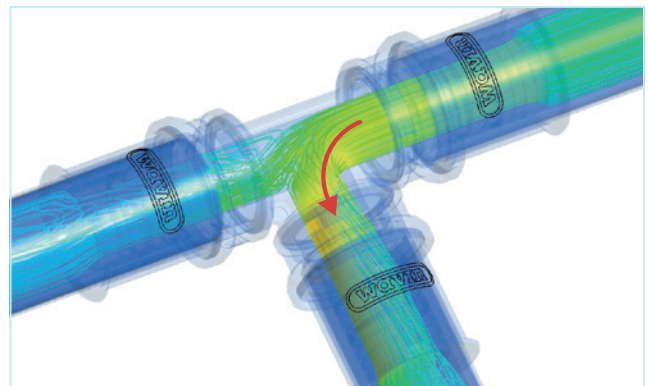

Figure 34: Flow conditions in a tee

## Selection of the right moulded parts

Once a system has been chosen, the choice of fittings should be considered. There is also some potential here to minimise installation noise from the beginning.

Fittings with an inner radius have hydraulic advantages and be loaded more heavily than fittings without a radius. The inner radius also reduces flow noise and prevents dripping.

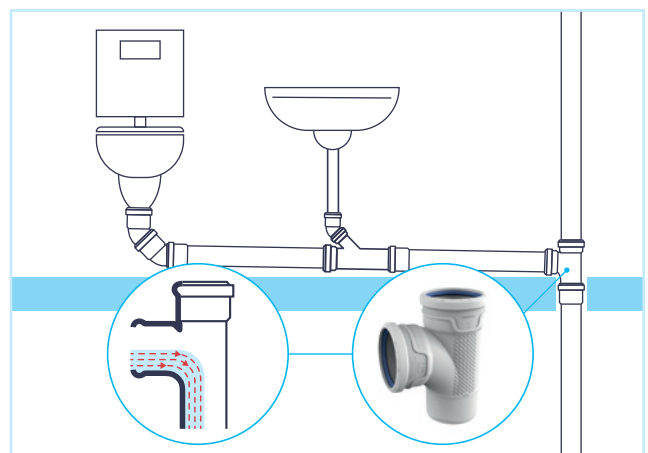

Figure 35: Representation of streamlined moulded parts

This is why you will  
hear a train before you  
can see it.



18,000 km/h

is the speed of sound in iron

**Somewhere in the Midwest of the USA**

Cowboys in old western movies like to put their ears to the rails to hear if a train is coming. It actually works: Sound is transmitted faster through solids than through the air. Specifically, sound travels 5,000 m/s in iron, while it only manages 340 m/s over air (at 20° C). You can hear an approaching train over the iron rails in time to prepare – in the Western movie – for the robbery.

## Using structure-borne sound decoupled wall panels

Wall panels with sound decoupling should also be used in the drinking water area. Sound decouplers are usually made of rubber and are pressed over the wall panel before installation. The wall panel has no direct contact with the wall and structure-borne sound transmission is successfully minimised. Sound insulation values can be found in the drinking water technical manual.



Figure 36: Sound insulation sets

## Choose matching pipe clamps

To meet noise targets, pipe systems need to be professionally installed to the wall.

The choice of pipe clamp is essential for this. Many manufacturers of pipe clamps offer coordinated solutions here, as do suppliers of entire installation systems.

The elastomer insert of the pipe clamp is relevant here. It should also be designed for the particular installation system used.



Figure 37: Different types of pipe clamps

This risk is reduced with system brackets which are designed for the pipe system.



**Video**  
Installing system  
clamps correctly:  
<https://bit.ly/3Aq7F3F>





Many standardised pipe clamps on the market have a span range for several outside diameters: e.g., 108 mm – 114 mm. If the pipe clamps are completely tightened during installation, or if they are not selected to match the outer diameter of the pipes, structure-borne noise transmission will increase. On the one hand, there must be sufficient clamping force to hold the pipe systems securely. On the other hand, the elastomer insert must not be compressed too far; otherwise, the damping of the pipe clamp will be lost.

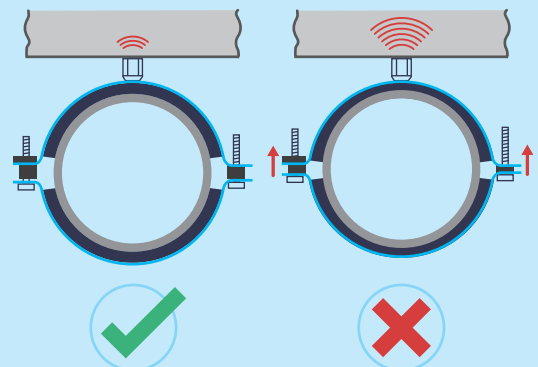

Figure 38: Compression

# Installing the sound insulation components

## Use sound insulation

It is necessary to insulate pipes before installation in some cases. This may be the case to prevent condensation, or to achieve further damping of air and structure-borne sound transmission at problem areas. In other words, where strong deflections in wastewater pipes cannot be avoided, or at impact zones of wastewater from downpipes or where local regulations apply. The wastewater pipes are often completely covered with sound insulation in wood-frame construction, where there is less mass. Sound attenuation values for the insulation material is specified in manufacturers' data sheets.



**Figure 39:** Wastewater pipe with sound insulation hose



Inspect the installation materials for damage in advance. If pipes need to be cut to length, ensure that the cut edges are chamfered and deburred correctly. This also avoids possible interference noise later on.

## Installing pipes and pipe clamps

Pipes must always be installed without stress. Otherwise, there is too high a transmission of structure-borne sound. Pipe clamps or brackets should be installed straight and plumb. The spacing of the pipe clamps can vary since walls are sometimes not completely straight, particularly in existing buildings. Every pipe clamp must be aligned individually. You need to use the correct anchors to fix the hanger bolts of the pipe clamps with the masonry. Plastic fixing plugs are of benefit from an acoustic point of view, but of course they must be suitable for the application.

Look at the pipe clamps after installation: If a unilateral compression of the elastomer is already visible there should be some adjustments.



**Avoid structure-borne sound bridges.**



**Figure 40:** Aligning the pipe brackets correctly



**Figure 41:** Avoiding contact with profiles

## Wall and ceiling penetrations

Walls and ceiling penetrations can be a source of sound transmission and can lead to increased noise in protected rooms, so consideration to be given to this area of the installation. When installing pipe, sound insulation should be used in the wall or floor to achieve the best possible decoupling. Make sure that no structure-borne sound bridges are formed when filling the annular gap. Additional fire protection measures must be considered for wall and ceiling penetrations depending on the building class. This requires approval of the design by DIBt.



Figure 42: Setting up a sewage system for a floor slab

## Installing a tile backsplash and sanitary objects

Once the pipework has been installed, the tile splashback and sanitary objects are fitted. It is important that there is no contact of the tile with the pipe system, otherwise the result will be an installation unfavourable to sound. Structure-borne sound decouplings help when installing sanitary objects. Care must be taken to ensure that the fastening is not too strong and that it fits correctly.



Figure 43: Installation preparation for the ceramics

## Sound insulation certificates

The sound insulation certificates still have to be submitted once everything is installed. They can be requested from the respective manufacturers.

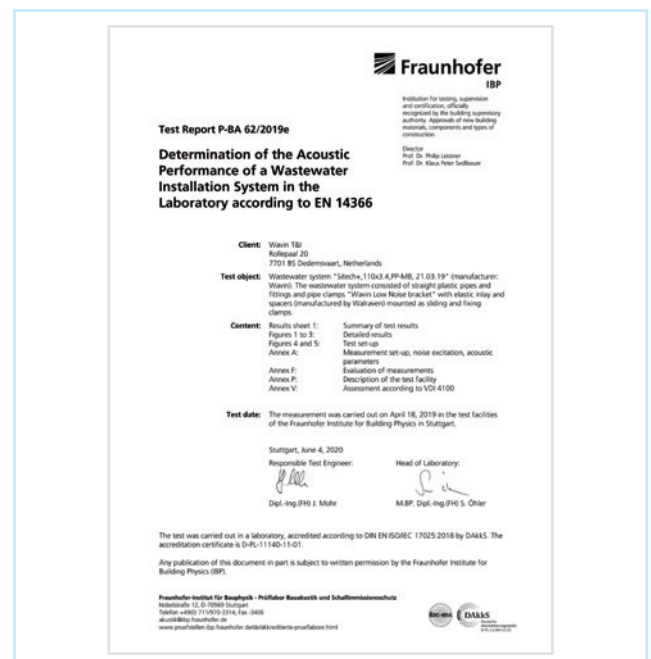
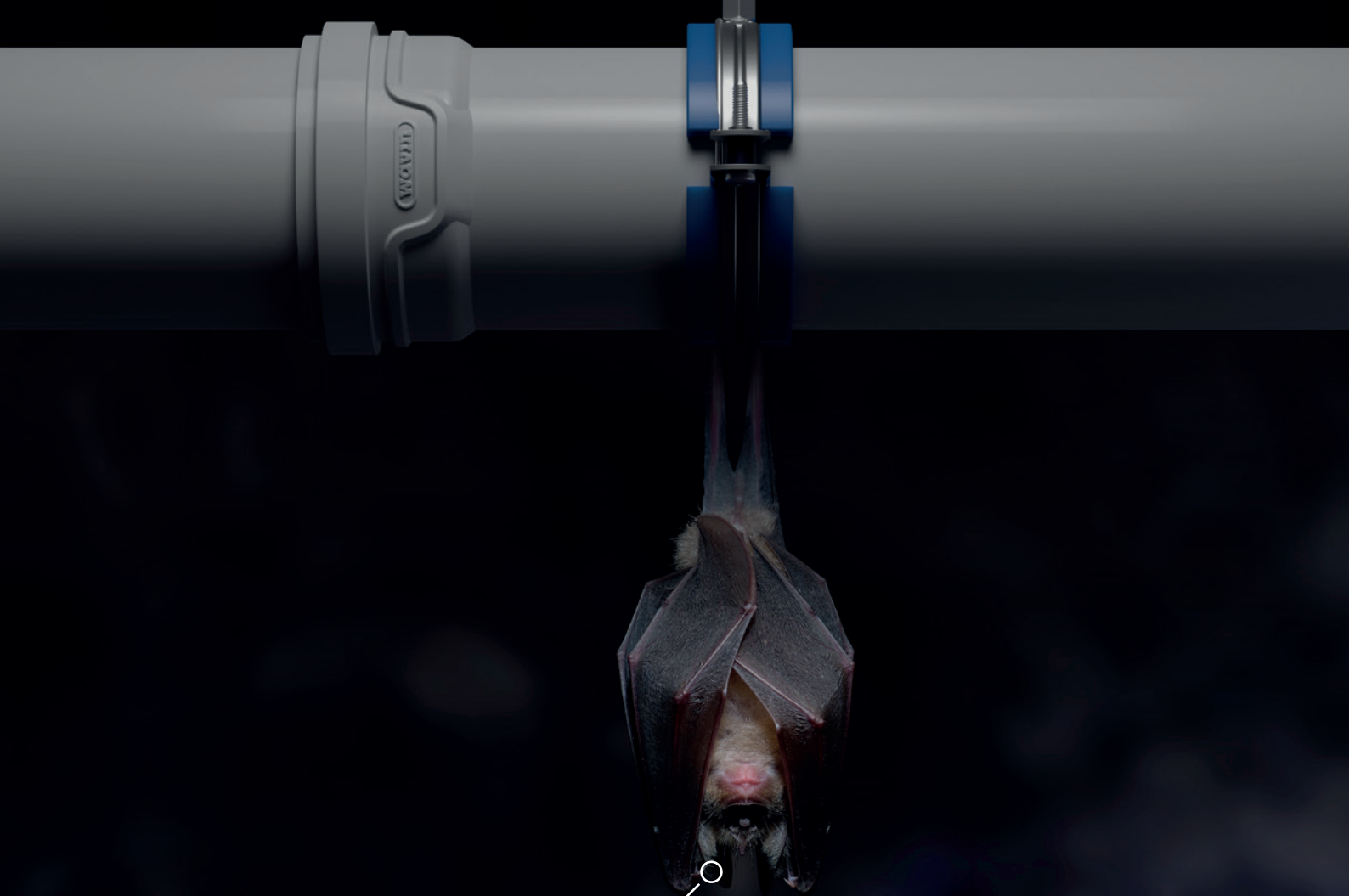

Figure 44: Fraunhofer IBP test report



# 200 kHz

The human hearing ability ends at 16 Hz to 18 kHz.

## The mammal with the best hearing.

### Hearing instead of seeing

Bats are the mammals that hear best because they are nocturnal and can hardly see in the dark. In contrast to humans, they emit ultrasonic calls in the high-frequency range to orient themselves by the reflections of sound waves. They keep on calculating how far away an object or a living being is and how fast it is moving in which direction.

# Sound insulation requirements during installation



## These sound insulation requirements must be observed during installation.

There are two subdivisions within the scope of sound insulation design and verification:

- ① Building code requirements  
DIN 4109 part 1-2
- ① Civil law requirements  
DIN 4109-5  
VDI 4100  
DEGA 103 Directive

DIN 4109 defines sound insulation requirements. These minimum construction requirements are to ensure that the user is protected from unreasonable annoyance due to sound transmission, provided that no abnormally loud noise is generated in the adjacent rooms.



**Attention:** There have already been some rulings that demand increased civil requirements if a certain equipment of the apartment is implemented. The choice of materials used must be observed.

## Minimum sound insulation

According to DIN 4109-1, the minimum sound insulation against noise from technical building systems and operations structurally connected to the building are as follows:

- ① supply and disposal facilities
- ① transport systems
- ① permanently installed operational equipment.

The following are also considered to be building services installations

- ① Communal washing facilities
- ① Swimming facilities, saunas, and the like
- ① Sports facilities
- ① Central vacuum cleaning systems
- ① Garage facilities
- ① Fixed motorised external sunshades and roller shutters.

User noises, such as placing a toothbrush cup on a storage plate, closing the toilet lid hard, sliding in the bathtub, or noises from portable machines and appliances (e.g., vacuum cleaners, washing machines, kitchen appliances, and sports equipment) in one's own living area are not subject to the requirements listed.

These minimum requirements can be made more stringent with civil agreements. Increased sound insulation requirements can be agreed, for example, in DIN 4109-5 and VDI 4100.



**The sound insulation requirements for building services equipment according to DIN 4109-1**

NOISE SOURCE	TYPE OF ROOMS TO BE PROTECTED		
	Living rooms and bedrooms	Classrooms and workrooms	
	Max. permissible sound pressure level in dB(A)		
Water installations (water supply and sewage installations together) <sup>1) 2) 3)</sup>	$L_{AF,max,n} \leq 30$	$L_{AF,max,n} \leq 35$	
Other in-house, permanently installed technical sound sources of technical equipment, supply, and disposal as well as garage systems	$L_{AF,max,n} \leq 30$ <sup>3)</sup>	$L_{AF,max,n} \leq 35$ <sup>3)</sup>	
Restaurants, including kitchens, sales outlets, establishments, etc.	☀ tags 6 AM to 10 PM	$L_r \leq 35$ $L_{AF,max} \leq 45$	$L_r \leq 35$ $L_{AF,max} \leq 45$
	🌙 at night according to TA noise	$L_r \leq 25$ $L_{AF,max} \leq 45$	$L_r \leq 35$ $L_{AF,max} \leq 45$

<sup>1)</sup> Individual, short-term noise peaks that occur when operating the fittings and equipment (opening, closing, switching, interrupting, etc.) are not to be considered.  
<sup>2)</sup> Requirements to meet the permissible sound pressure level:  
 · The design documents must consider the sound insulation requirements, i.e., the required sound insulation certificates must be available for the building parts;  
 · In addition, the responsible construction management must be named and called in for a partial acceptance before the installation is closed or panelled.  
<sup>3)</sup> Deviating from DIN EN ISO 10052 (2010-10), 6.3.3, measurement in the loudest corner of the room is omitted (see also DIN 4109-4).

**Table 2:** Values for the permissible sound pressure levels in rooms to be protected from noise from technical building systems and operations structurally connected to the building in accordance with DIN 4109-1 (source no. 1)

**The sound insulation requirements for building services equipment according to DIN 4109-5:**

NOISE SOURCE	TYPE OF ROOMS TO BE PROTECTED	
	Living rooms and bedrooms in apartment buildings	Living rooms and bedrooms in single-family terraced and semi-detached houses
	Max. permissible sound pressure level in dB(A)	
Water installations (water supply and sewage installations together) <sup>1) 2) 3)</sup>	$L_{AF,max,n} \leq 27$ <sup>1) 2) 3)</sup>	$L_{AF,max,n} \leq 25$ <sup>1) 2) 3)</sup>
Other in-house, permanently installed technical sound sources of technical equipment, supply, and disposal as well as garage systems	$L_{AF,max,n} \leq 27$ <sup>3)</sup>	$L_{AF,max,n} \leq 25$ <sup>3)</sup>

<sup>1)</sup> Individual, short-term noise peaks that occur when operating the fittings and equipment (opening, closing, switching, interrupting, etc.) are not to be considered.  
<sup>2)</sup> Requirements to meet the permissible sound pressure level:  
 · The design documents must consider the sound insulation requirements, i.e., the required sound insulation certificates must be available for the building parts;  
 · In addition, the responsible construction management must be named and called in for a partial acceptance before the installation is closed or panelled.  
<sup>3)</sup> Deviating from DIN EN ISO 10052 (2010-10), 6.3.3, measurement in the loudest corner of the room is omitted (see also DIN 4109-4).

**Table 3:** Maximal permissible sound pressure levels in rooms to be protected from noise from technical building systems and operations structurally connected to the building in accordance with DIN 4109-5 (source no. 2)

**The sound insulation requirements for building services equipment according to VDI 4100**

TYPE OF NOISE EMISSION	PERCEPTION OF IMMISSION FROM AN ADJACENT APARTMENT <sup>1)</sup>		
	SSt I	SSt II	SSt III
Loud language	understandable	generally understandable	generally incomprehensible
Language with normal speech	generally incomprehensible	incomprehensible	inaudible
Walking sounds	generally annoying	generally no longer annoying	not annoying
Noise from building services equipment	Unreasonable annoyance will be generally avoided	occasionally annoying	not or only rarely annoying

<sup>1)</sup> Assumption: evening background noise level of 20 dB(A) and usual large recreation rooms.

**Table 4:** Perception of usual noises from adjacent apartments and assignment to the three sound insulation levels (SSt) I to III according to VDI 4100 (source no. 3)

**Sound insulation of noise from building services installations**

 <b>NOISE</b>	max. permissible sound pressure level			
	SSt I	SSt II	SSt III	
 <b>Flats in apartment buildings</b>				
of water installations (water supply and sewage installations together)	$L_{AF, max, nT}$ $nT$ in dB	<= 30	<=27	<=24
 <b>Semi-detached and terraced houses</b>				
of water installations (water supply and sewage installations together)	$L_{AF, max, nT}$ $nT$ in dB	<= 30	<=25	<=22
 <b>Own area</b> (house or flat used by the owner)		SSt EB 1	SSt EB 2	
of water installations (water supply and sewage installations together)	$L_{AF, max, nT}$ $nT$ in dB	35	30	

**Table 5:** Maximal permissible sound pressure levels in rooms to be protected from noise produced by technical building systems and operations structurally connected to the building in accordance with VDI 4100 (source no. 3)

**Levels SST1 – SST3 apply according to the following table and also depend on the equipment of the buildings**

SOUND INSULATION LEVEL	EXPECTATION
I	... for (newly built) flat where the execution and equipment is raised as compared to a most simple execution and equipment.
II	... for a flat that meets average comfort requirements in its other design and equipment as well.
III	... for a flat that also meets special comfort requirements in terms of its other design and equipment as well as location.
EB I	... to a certain level of sound insulation even in their own area.
EB II	... to higher sound insulation even in their own area.

**Table 6:** Allocation of sound insulation levels I to III to dwellings with different comfort requirements according to VDI 4100 (source no. 3)

## DEGA recommendation 103

The sound insulation in accommodation units is classified on the basis of sound insulation classes A\* to F or EW 1 to EW 3 for their own living area. The following protection classes can be agreed here for building services equipment:

SOUND INSULATION CLASS	DESCRIPTION
Class A*	Accommodation unit with very good sound insulation, which allows undisturbed living almost without consideration for neighbours.
Class A	Accommodation unit with very good sound insulation, which allows undisturbed living almost without too much consideration for neighbours.
Class B	Accommodation unit with good sound insulation, which, with mutual consideration between neighbours, allows quiet living with a large degree of privacy.
Class C	Accommodation unit with perceptibly better sound insulation than class D, where occupants generally find peace and quiet and confidentiality is maintained with customary considerate residential behaviour.
Class D	Accommodation unit with sound insulation that essentially complies with the requirements of DIN 4109-1 for multi-story buildings with apartments and workrooms and thus protects the occupants in common rooms from unacceptable nuisance due to sound transmission from other accommodation units and from outside for the sake of health protection. It cannot be expected that noises from other accommodation units or from outside will no longer be perceived. This requires mutual consideration by avoiding unnecessary noise. The requirements assume that no unusually strong noise is caused in adjacent rooms.
Class E	Accommodation unit with sound insulation that does not meet the requirements of DIN 4109-1. Annoyance due to sound transmission from other accommodation units and from outside is possible; special consideration is absolutely necessary. Confidentiality is no longer ensured.
Class F	Accommodation unit with poor sound insulation, which is significantly below the requirements of DIN 4109-1. Annoyance due to sound transmission from other people's accommodation units and from outside must be expected even with conscious consideration; confidentiality cannot be expected.

**Table 7:** Assignment of sound insulation levels A\* to F for normal residential use according to DEGA Guideline 103 (source nos. 4 and 5)

NOISE		SOUND INSULATION CLASS						
		F	E	D	C	B	A	A*
Noise from water installations and building services, <sup>1) 2)</sup> user noise from urination	$L_{AF, max;n}$ in dB(A)	> 35	≤ 35	≤ 30	≤ 27	≤ 24		≤ 20

<sup>1)</sup> If no low-frequency noise components are present (i.e., if the difference between the C-weighted and A-weighted sum levels according to DIN 45 680 is less than 20 dB), bonus points are awarded in the sound insulation certificate. The requirements also apply to heating and ventilation systems in their own area.  
<sup>2)</sup> In the case of metrological verification,  $L_{AF, max;nT}$  can also be used as an alternative for the evaluation.

**Table 8:** Requirements for noise from water installations, building services equipment according to DEGA recommendation 103

SOUND INSULATION CLASS						
F	E	D	C	B	A	A*
no special measures	Planning information according to DIN 4109	such as E and careful structure-borne sound decoupling of all building parts	such as D and also all curtain wall installations produced in dry-wall construction	two-shell construction is required	two-shell construction with high sound insulation is required	such as A

**Table 9:** Guiding planning information for the grouping of expected user noise and structure-borne sound decoupling, depending on the individual classes according to DEGA recommendation 103

## International requirements

International requirements also apply to rooms to be protected, such as bedrooms but also living rooms. The table here reflects the requirements that must be met by building services equipment.

LIMIT VALUES TO BE COMPLIED WITH FOR THE BUILDING INSTALLATION				
	 Bedroom	 Living room		
	dB(A)	dB(A)	Description of value	Directive
Germany	25-30	30	$L_{A,f,max,n}$	DIN 4109 standard requirements and DIN 4109-5 increased requirements
Italy	35	35	$L_{A,Smax}$	Reference standard is DPCM 05/12/1997 "Determination of requirements for passive acoustics of buildings"
Denmark	20-35*	20-35*	$L_{p,ALF}$	Building Code 2018 and DS 490 "Sound classification of dwellings"
Norway	20-35*	20-35*	$L_{p,A,T}$	Technical building regulations (TEK 17) and NS 8175: 2012 Sound conditions in buildings – Sound classes for different types of buildings
Sweden	27-35*	27-35*	$L_{p,AF,max,nT}$	a. Building regulations BBR, SS 25267: 2015 (apartments) and SS 25268 (schools/hotels)
Finland	29-35*	29-35*	$L_{AF,max,T}$	Standard SFS 5907 ("Acoustic classification of buildings")
UK	30	30	$L_{a,max}$	(2010) in Approved Document E "Resistance to the passage of sound"
Ireland	30	30	$L_{a,max}$	(2010) approved document E "Resistance to the passage of sound"
Czech Republic	30	30	$L_{a,max}$	ČSN 73 0532:2020
Netherlands	30	30	$L_{i,A,k}$	Installation noises specified in NEN5077
Indonesia	30	40	$L_{eq}$	SNI 03-6386-2000 standard requirements
Baltics	35	35	$L_{AeqT}$	DIN 4109

\*Depending on the building TYPE class A-D

**Table 10:** International requirements for buildings

## Practical advice:

"I want to work as quickly and efficiently as possible on the construction site. Without any defects, of course, so that I don't have to fix any defects later. Good preparation of my assignment is, therefore, essential for me. Where sound insulation is concerned, I prefer to have everything on site from a single source: a convincing pipe system from a manufacturer I can trust. Consider carefully whether to resort to any DIY solutions, or rather use proven good material. It is advisable to consult the planner of the building project in detail. You will know exactly about the special requirements.

It is also important to still provide the soundproofing certificates after the actual installation. It's good to have someone here to help you with that or do all the work with it."

Simon B., installer



### Practical advice

- ① Select fittings that are designed for good flow.
- ① Use moulded parts with inner radius in the wastewater area.
- ① Use wall panels with structure-borne sound decoupling.
- ① Use system pipe clamps that fit the respective pipe system.
- ① Use sound insulation over pipes in problem areas and where local regulations require it.



### Interfaces

- ① As an installer, you are the last trade in a chain that begins with planning and architecture. Above all, coordinate with the planning office if you have questions about the correct implementation of the sound insulation specifications.
- ① Use of the right pipe system including the associated system components is a decisive factor for optimum sound insulation. Follow the recommendations of the planning office here or seek advice from a competent manufacturer.



### Attention!

Once the pipe clamps are installed, you should take another close look: If you detect unilateral compression of the elastomer, you should readjust directly.



### Legal matters

Building code requirements for installation

① DIN 4109 part 1-2

Civil law requirements for installation

① DIN 4109-5

① VDI 4100

① DEGA 103 guideline

# Acoustic system testing





# Acoustic evaluation of sanitary engineering

There are several assessment options since the acoustic evaluation of sanitary engineering is complex. These include tests according to DIN EN 14366, which enable a good product comparison. Tests in the system give the results according to DIN 4109. The various influences are considered, such as cistern, curtain wall, installation wall and installation material here.

# Testing according to DIN EN 14366

It is important to determine the choice of materials before installation for designers and installers. There are several ways to do this.

The DIN EN 14366 standard describes a test setup for testing the material of wastewater systems (also well suited for development). If the same boundary parameters are selected for the test, the results can be compared well with each other. However, this does not reflect the real conditions, with triggering of a flushing process and the influences of typical components of a curtain wall system.

**Boundary parameters include:**

- ⊕ Same type of pipe clamp and same compression of the elastomer
- ⊕ Positions of the fixed and sliding clamps must be defined identically
- ⊕ Use of the same pipe dimension

A constant water flow of 0.5 l/s, 1 l/s, 2 l/s, and 4 l/s is then generated during the test.

**The results are then stated as:**

- ⊕ Airborne sound pressure level  $L_{b,A}$  in dB(A) according to DIN EN 14366
- ⊕ Characteristic structure-borne sound level  $L_{SC,A}$  in dB(A) according to DIN EN 14366

The characteristic structure-borne sound level is strongly dependent on the boundary parameters. If only one marginal parameter differs between different manufacturers, the results are poorly comparable.

The airborne sound pressure level  $L_{b,A}$  reflects well the influence of the selected pipe material. The measuring room here is also the installation space.

Using the example of the Wavin SiTech+ comfort sound insulation pipe system in comparison with the Wavin AS+ premium sound insulation pipe system, the differences in the airborne sound pressure level are shown as an example:

Pipe system	Evaluation	Volume flow in l/s				Fraunhofer IBP test report
		0.5	1.0	2.0	4.0	
Wavin SiTech+	Airborne sound pressure level $L_{b,A}$ in dB(A) according to DIN EN 14366	46	49	52	55	P-BA 25-1/2016
Wavin AS+	Airborne sound pressure level $L_{b,A}$ in dB(A) according to DIN EN 14366	41	45	48	50	P-BA 64/2019

**Table 11:** Influence of the pipe quality on the airborne sound pressure level

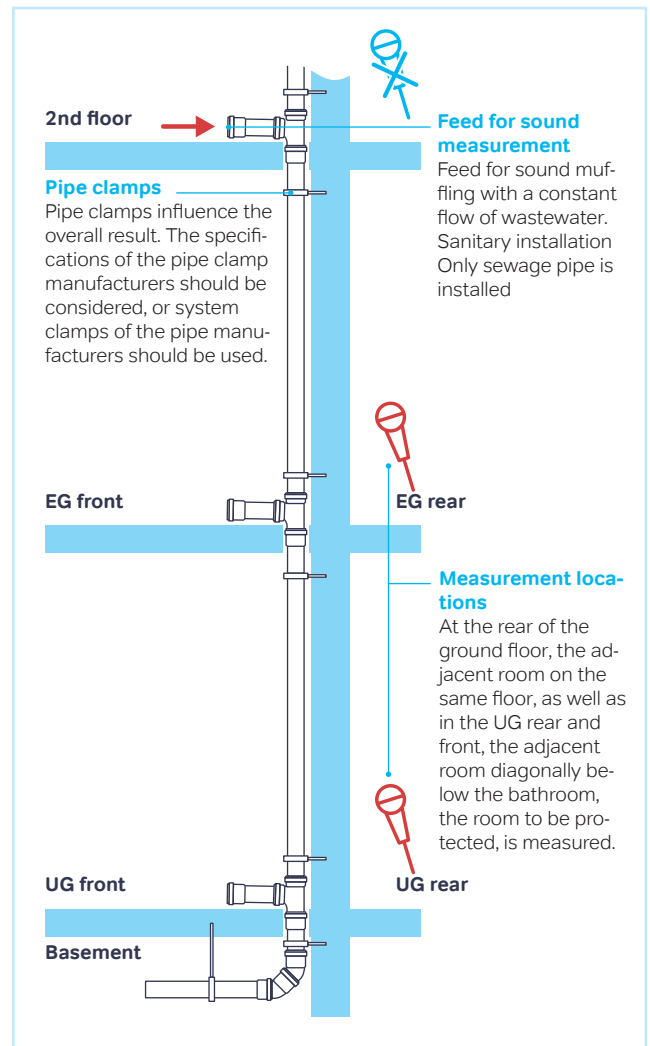

**Figure 45:** Measurement setup according to DIN EN 14366

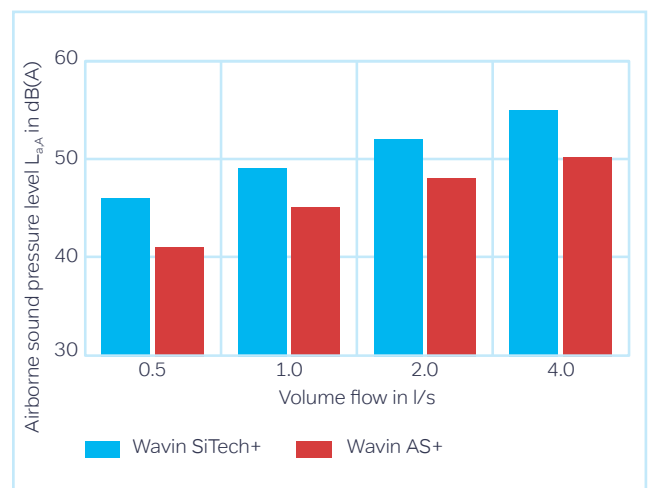

**Figure 46:** Influence of the pipe quality on the airborne sound pressure level



# Measurement according to DIN 4109

A more complex test setup is necessary to be able to evaluate a system consisting of different components. A real case corresponding to the practical application is set up to achieve the sound insulation targets of **DIN 4109**.

## Tested in different versions

- ⌚ Curtain wall in front of an installation wall, solid
- ⌚ Curtain wall in front of an installation wall, drywall

This is determined by various influencing factors such as the cistern (triggering and refilling), the curtain wall, wastewater and drinking water systems.

Each of these components contributes its part to determine the total installation sound level  $L_{AF, max,n}$ .

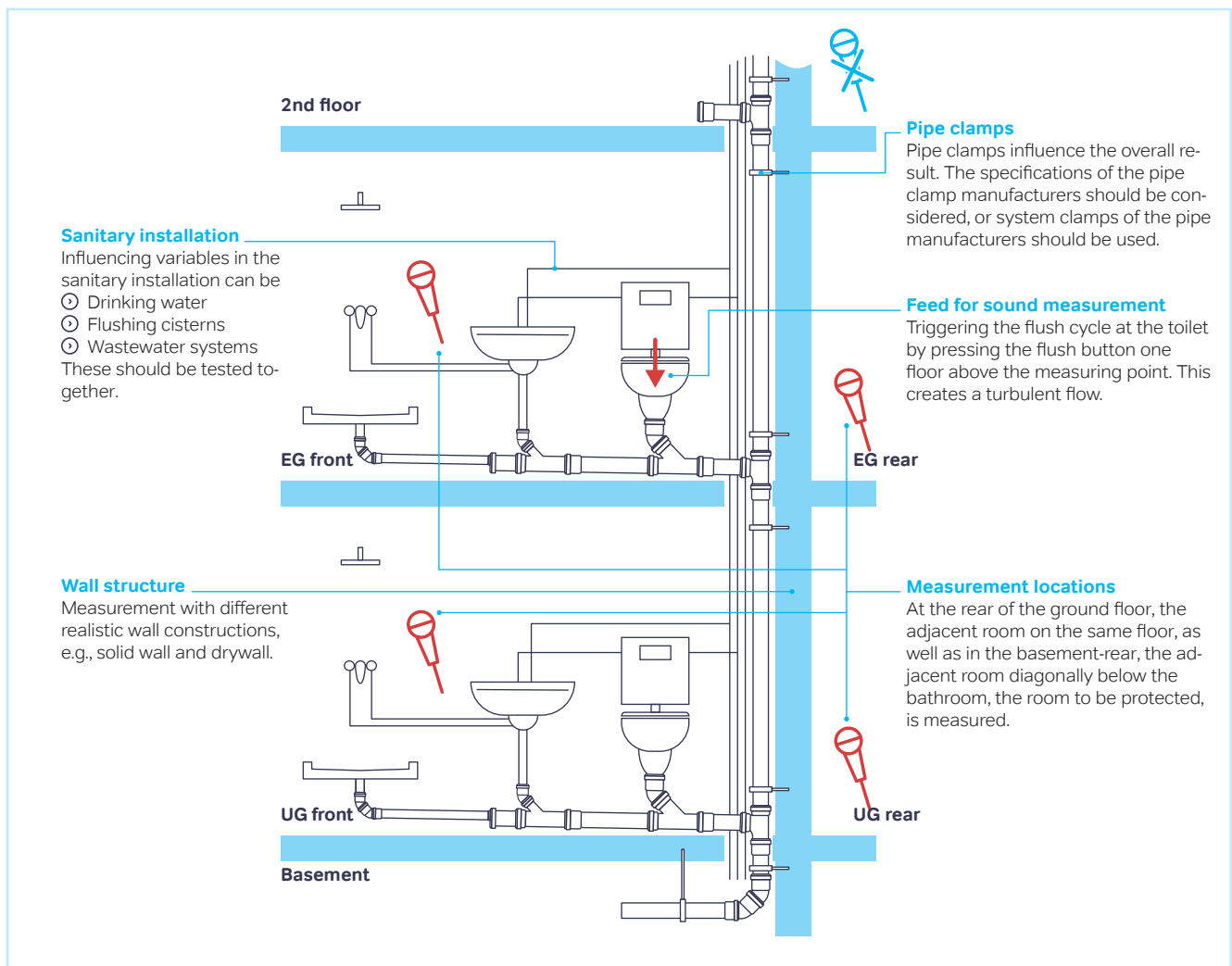

**Figure 47:** Representative setup for a measurement under real conditions.

Everything must be carefully planned and installed to be able to achieve the required values later. The recommendations in the planning and installation chapter of this brochure will help here.

# System testing according to DIN 4109

Measurements are then taken in the measuring room at a large and a small flush volume. The flush is triggered directly from the toilet on the ground floor in front. The maximum sound pressure level is measured at the start and during the rinsing and filling process.

This should be considered in order to comply with or fall below the DIN 4109 limits, or to meet the increased requirements of DIN 4109-5:

- ① High quality cistern
- ② Curtain wall system with decoupling from masonry
- ③ High-quality pipe clamps with attachment to the curtain wall system
- ④ Proper installation of all components
- ⑤ Selection of the right wastewater piping system for the planned application



**Important:** Various test structures have shown which criteria are decisive for the final result:

- ⌚ The choice of the house drainage pipe system
- ⌚ The curtain wall system used
- ⌚ The cistern

The main noise is generated by the triggering of the flushing process, or by the impact noise at the bottom of the downpipe.

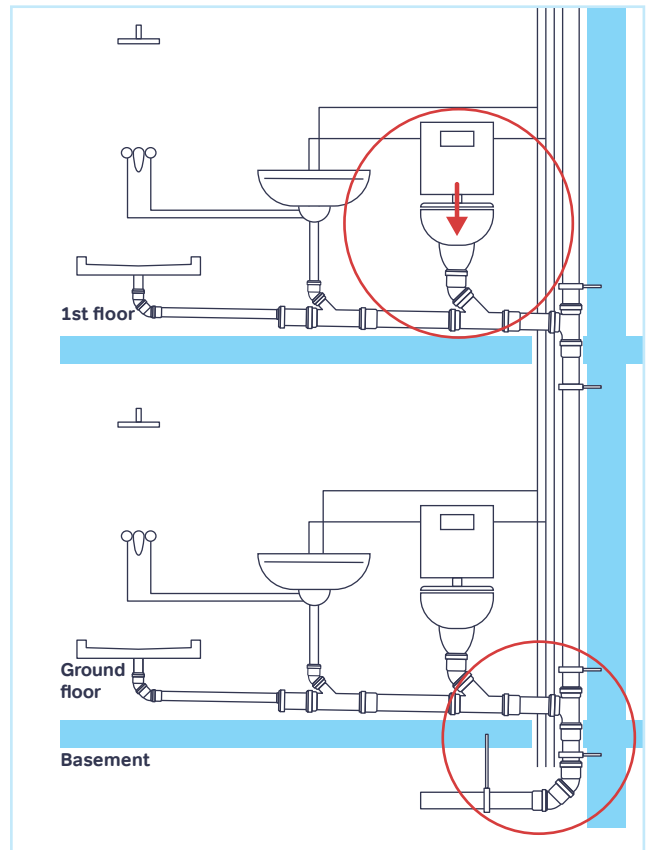

Figure 48: Main sound sources according to DIN 4109

## Greater fault tolerance with heavier pipe system.

Since there are basically several possible sources of error during the installation of the drainage system, a heavier pipe system is recommended here. This is because it can also compensate for slight errors during installation.

Baufachlich anerkannte Stelle  
für Prüfung, Überwachung und  
Zertifizierung  
Zulassung neuer Baustoffe, Bauteile  
und Bauarbeiten  
Institutsleiter  
Prof. Dr. Philipp Leitzner  
Prof. Dr. Klaus Peter Sedlbauer

**Prüfbericht P-BA 10/2022**

**Prüfbericht und Eignungsnachweis  
über das Geräuschverhalten von  
Sanitärinstallationen an einer  
Massivwand im Prüfstand**

**Auftraggeber:** Wavin GmbH  
Industriestraße 20  
D-49767 Twist

**Prüfobjekte:** Sanitärinstallationen in Verbindung mit einer teilweisen Vorwandinstallation mit saunhochem Schacht "TECEprofil Trockenbauprofil" der Fa. TECE GmbH in Vorwandbauweise mit praesprechter Zu- und Abwasserführung, der Fa. Wavin GmbH (Wavin Tigris Mehrschicht-verbundrohr mit KSM5 Fittings, Wavin AS+), angebracht an einer Massivwand (Masterinstallation).

<b>Inhaltsverzeichnis:</b>	Ergebnisblatt 1 und 2: Zusammenfassung der Ergebnisse
Tabelle 1:	Beschreibung des Prüfobjekts (WC-Installation)
Tabelle 2 bis 4:	Detallergebnisse
Bild 1 bis 4:	Detallergebnisse
Bild 5 und 6:	Darstellung Versuchsaufbau
Anhang E:	Beschreibung Eignungsnachweis
Anhang F:	Auswertung
Anhang G:	Ausagefähigkeit der Messergebnisse
Anhang I:	Messdurchführung und Beurteilungsgrößen
Anhang P:	Beschreibung des Prüfstands
Anhang V:	Beurteilung nach VDI 4100

**Prüfdatum:** Die Messungen wurden im Juni 2021 im Technikum des Fraunhofer-Instituts für Bauphysik in Stuttgart durchgeführt.

Stuttgart, 24. Mai 2022

Bearbeiter: M.Sc. B. Kaltbeitzel

Prüfstellenleiter: M.BP. Dipl.-Ing.(FH) S. Öhler

Die Prüfung wurde in einem Prüflaboratorium des IBP durchgeführt, das nach DIN EN ISO/IEC 17025:2018 durch die DAkkS mit der Nr. D-PL-11140-11-01 akkreditiert ist.

Die genannten Messergebnisse beziehen sich nur auf das untersuchte Prüfobjekt. Eine auszugsweise Veröffentlichung ist nur mit Genehmigung des Fraunhofer-Instituts für Bauphysik gestattet.

**Fraunhofer-Institut für Bauphysik - Prüflabor Bauakustik und Schallmissionsschutz**  
 Nobelinstraße 12, D-70569 Stuttgart  
 Telefon +49(0) 7145070-3314, Fax -3405  
 akustik@ibp.fraunhofer.de  
 www.pruefstellen.ibp.fraunhofer.de/ibp/akkreditierung/prueflabore.html

Figure 49: Fraunhofer IBP test report

# Fraunhofer IBP test reports

## Fraunhofer IBP test report P-BA 19/2022 drywall Wavin AS+ and Wavin Tigris

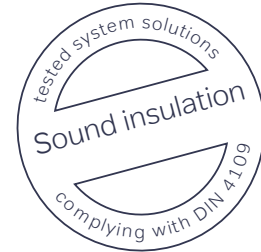
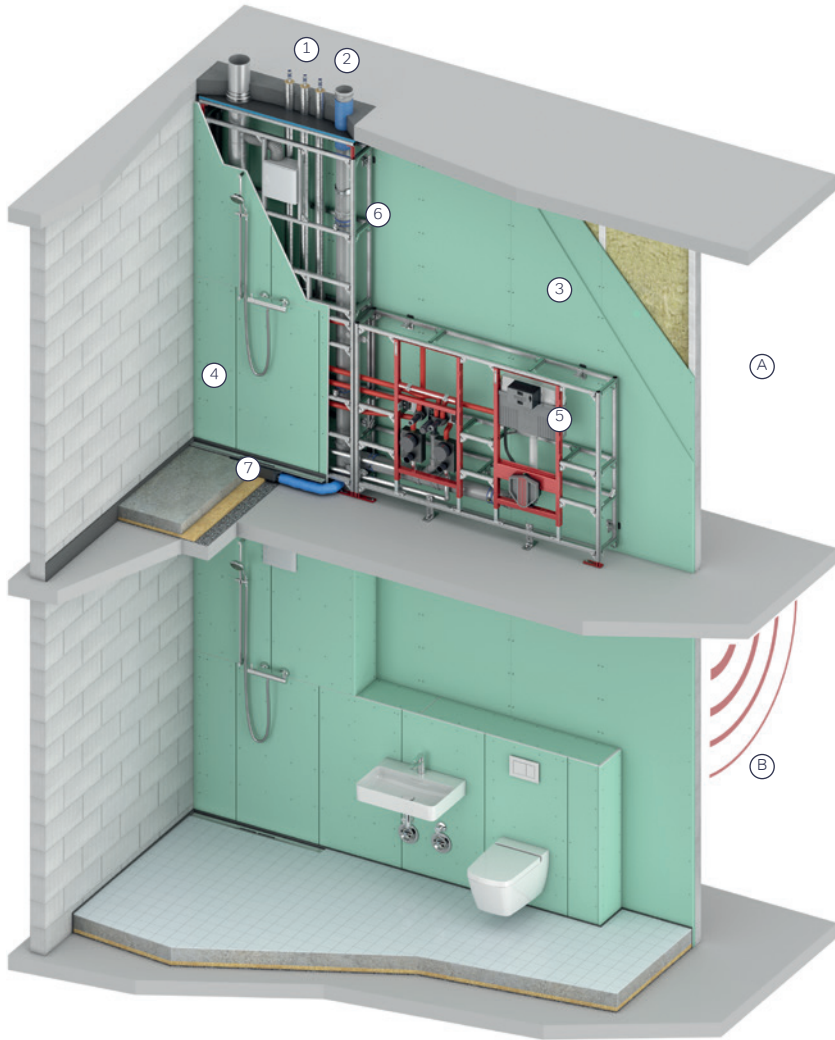

**Rooms**

- (A) Adjacent room, ground floor rear
- (B) Diagonal room underneath, basement rear

**Materials**

- ① Wavin Tigris K5/M5
- ② Wavin AS+ premium sound insulation
- ③ Plasterboard building panels on both sides and two layers with 12.5 mm thickness, filled with 60 mm mineral fibre insulation material
- ④ Plasterboard 18 mm thickness
- ⑤ Curtain wall TECEprofil, WC module with uni cistern
- ⑥ Fastening for wastewater via Wavin system clamp
- ⑦ Shower channel, TECEdrainprofile

**Installation noise according to DIN 4109, DIN 4109-5 and VDI 4100**

MEASUREMENT SITE	$L_{AF, max, n}$				$L_{AF, max, nT}$			
	RESULT ACCORDING TO	REQUIREMENTS ACCORDING TO			RESULT ACCORDING TO	REQUIREMENTS ACCORDING TO		
	DIN 4109:4 2016-07	DIN 4109:4 2018-01	DIN 4109-5 2020:08	DIN 4109-5 2020:08	VDI 4100: 2012-10	VDI 4100 SSt I	VDI 4100 SSt II	VDI 4100 SSt III
Diagonally underlying room (in the foreign area to be protected)	<b>19 dB(A)</b>	≤30 dB(A) ✓ <b>complied with</b>	≤27 dB(A) ✓ <b>complied with</b>	≤25 dB(A) ✓ <b>complied with</b>	<b>18 dB(A)</b>	≤30 dB(A) ✓ <b>complied with</b>	≤27 dB(A) ✓ <b>complied with</b>	≤24 dB(A) ✓ <b>complied with</b>
Adjacent room (in a dedicated area)	<b>27 dB(A)</b>	no requirements	no requirements	no requirements	<b>26 dB(A)</b>	EB I ≤35 dB(A) ✓ <b>complied with</b>	EB II ≤30 dB(A) ✓ <b>complied with</b>	no requirements

In the presentation of the results, the highest value is always indicated.

## Fraunhofer IBP test report P-BA 10/2022 solid wall Wavin AS+ and Wavin Tigris

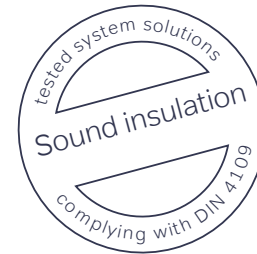
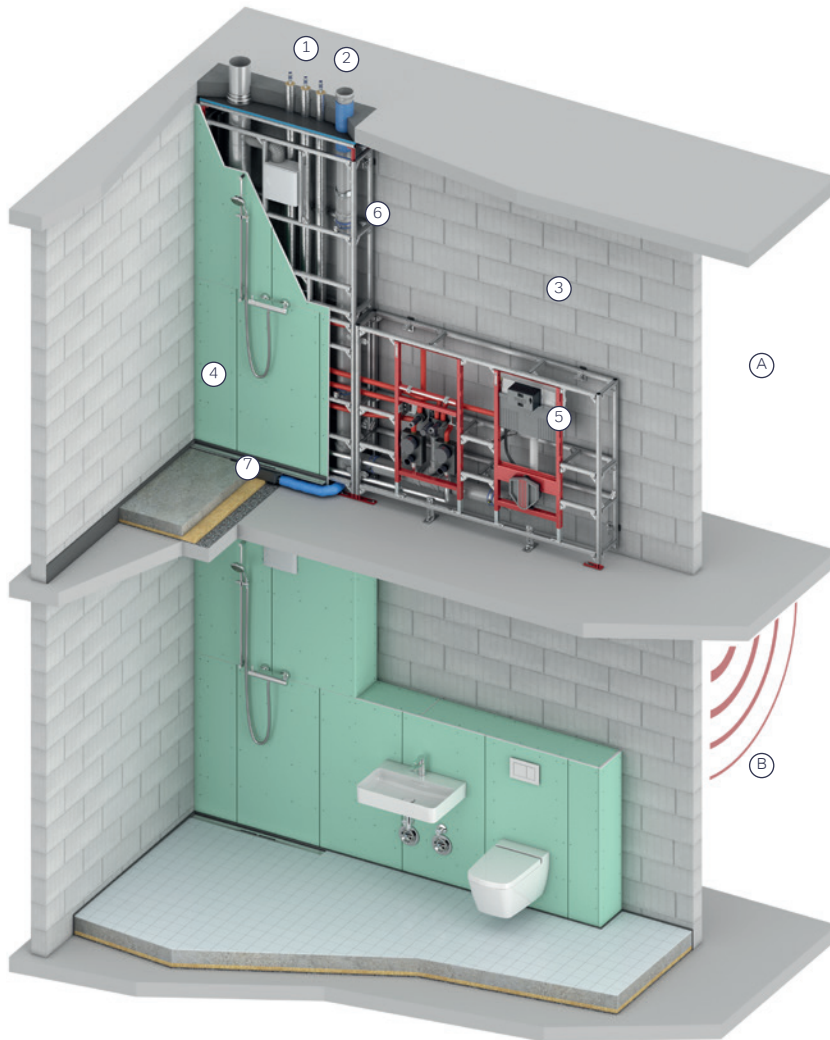

### Rooms

- (A) Adjacent room, ground floor rear
- (B) Diagonal room underneath, basement rear

### Materials

- ① Wavin Tigris K5/M5
- ② Wavin AS+ premium sound insulation pipe
- ③ Installation wall, solid 220 kg/m<sup>2</sup>
- ④ Plasterboard 18 mm thickness
- ⑤ Curtain wall TECEprofil, WC module with uni cistern
- ⑥ Fastening for wastewater via Wavin system clamp
- ⑦ Shower channel, TECEdrainprofile

### Installation noise according to DIN 4109, DIN 4109-5 and VDI 4100

MEASUREMENT SITE	$L_{AF, max, n}$				$L_{AF, max, nT}$			
	RESULT ACCORDING TO	REQUIREMENTS ACCORDING TO			RESULT ACCORDING TO	REQUIREMENTS ACCORDING TO		
	DIN 4109:4 2016-07	DIN 4109:4 2018-01	DIN 4109-5 2020:08	DIN 4109-5 2020:08	VDI 4100: 2012-10	VDI 4100 SSt I	VDI 4100 SSt II	VDI 4100 SSt III
Diagonally underlying room (in the foreign area to be protected)	23 dB(A)	≤30 dB(A) ✓ complied with	≤27dB(A) ✓ complied with	≤25 dB(A) ✓ complied with	20 dB(A)	≤30 dB(A) ✓ complied with	≤27dB(A) ✓ complied with	≤24 dB(A) ✓ complied with
Adjacent room (in a dedicated area)	29 dB(A)	no requirements	no requirements	no requirements	25 dB(A)	EB I ≤35 dB(A) ✓ complied with	EB II ≤30 dB(A) ✓ complied with	no requirements

In the presentation of the results, the highest value is always indicated.

# Fraunhofer IBP Test Report P-BA 20/2022 Drywall Wavin AS+ and Wavin SiTech+ and Wavin Tigris

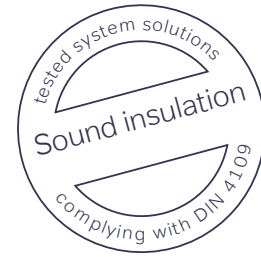
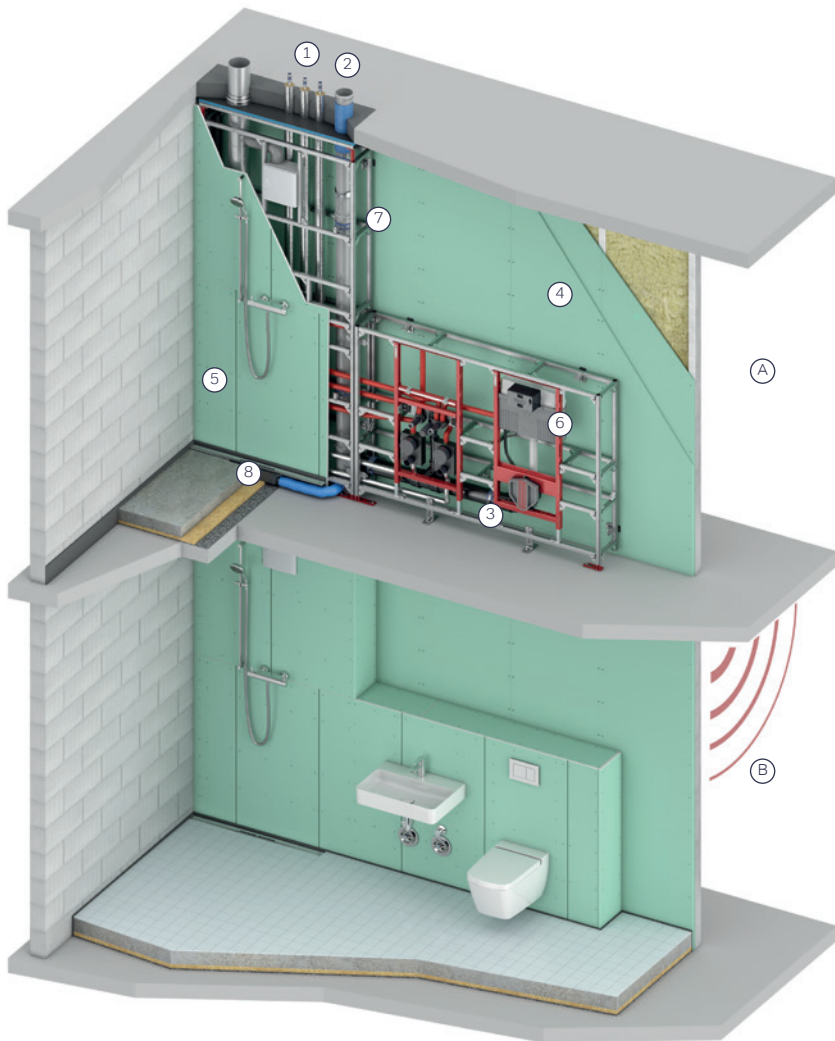

**Rooms**

- (A) Adjacent room, ground floor rear
- (B) Diagonal room underneath, basement rear

**Materials**

- ① Wavin Tigris K5/M5
- ② Wavin AS+ premium sound insulation (downpipe)
- ③ Wavin SiTech+ (floor)
- ④ Plasterboard building panels on both sides and two layers with 12.5 mm thickness, filled with 60 mm mineral fibre insulation material
- ④ Plasterboard 18 mm thickness
- ⑤ Curtain wall TECEprofil, WC module with uni cistern
- ⑥ Fastening for wastewater via Wavin system clamp
- ⑦ Shower channel, TECEdrainprofile

**Installation noise according to DIN 4109, DIN 4109-5 and VDI 4100**

MEASUREMENT SITE	L <sub>AF, max, n</sub>				L <sub>AF, max, nT</sub>			
	RESULT ACCORDING TO	REQUIREMENTS ACCORDING TO			RESULT ACCORDING TO	REQUIREMENTS ACCORDING TO		
	DIN 4109:4 2016-07	DIN 4109:4 2018-01	DIN 4109-5 2020:08	DIN 4109-5 2020:08	VDI 4100: 2012-10	VDI 4100 SSt I	VDI 4100 SSt II	VDI 4100 SSt III
Diagonally underlying room (in the foreign area to be protected)	18 dB(A)	≤30 dB(A) ✓ <b>complied with</b>	≤27dB(A) ✓ <b>complied with</b>	≤25 dB(A) ✓ <b>complied with</b>	18 dB(A)	≤30 dB(A) ✓ <b>complied with</b>	≤27dB(A) ✓ <b>complied with</b>	≤24 dB(A) ✓ <b>complied with</b>
Adjacent room (in a dedicated area)	29 dB(A)	no requirements	no requirements	no requirements	27 dB(A)	EB I ≤35 dB(A) ✓ <b>complied with</b>	EB II ≤30 dB(A) ✓ <b>complied with</b>	no requirements

In the presentation of the results, the highest value is always indicated.

# Fraunhofer IBP Test Report P-BA II/2022 Solid wall Wavin AS+ and Wavin SiTech+ and Wavin Tigris

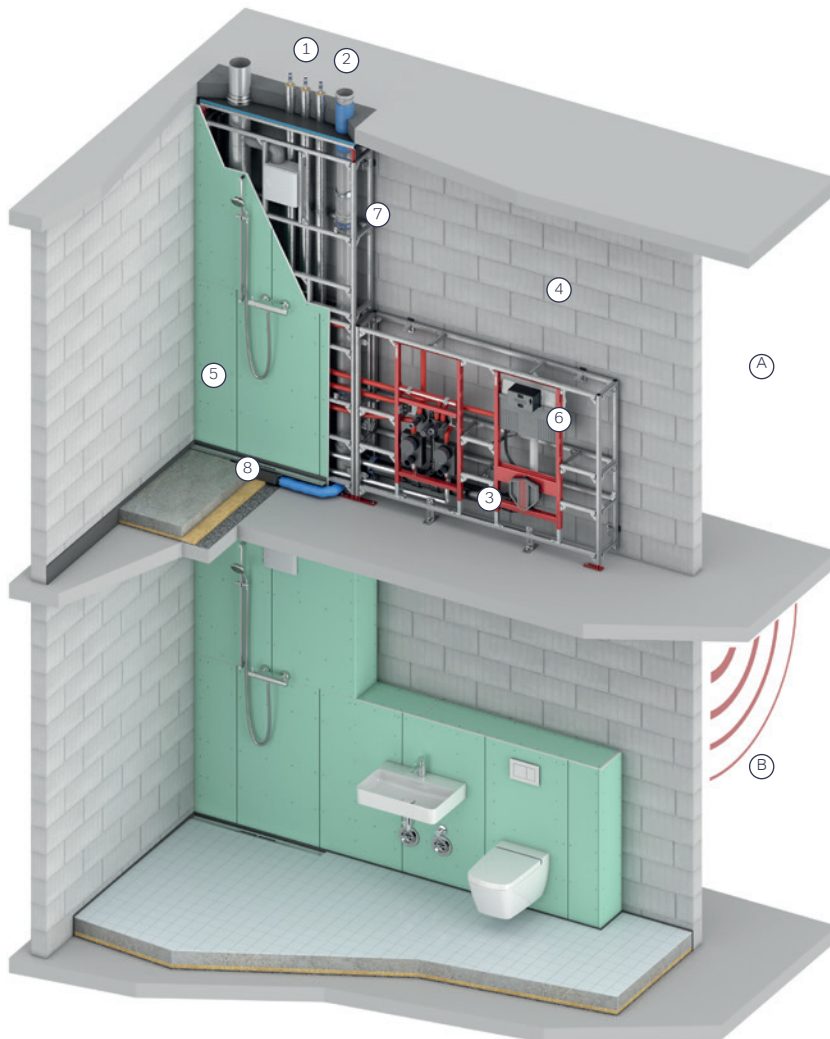
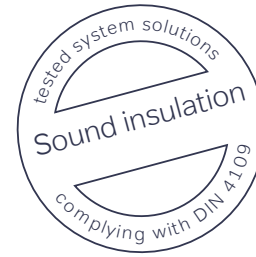

**Rooms**

- (A) Adjacent room, ground floor rear
- (B) Diagonal room underneath, basement rear

**Materials**

- (1) Wavin Tigris K5/M5
- (2) Wavin AS+ premium sound insulation (downpipe)
- (3) Wavin SiTech+ (floor)
- (4) Installation wall, solid 220 kg/m<sup>2</sup>
- (5) Plasterboard 18 mm thickness
- (6) Curtain wall TECEprofil, WC module with uni cistern
- (7) Fastening for wastewater via Wavin system clamp
- (8) Shower channel, TECEdrainprofile

**Installation noise according to DIN 4109, DIN 4109-5 and VDI 4100**

MEASUREMENT SITE	L <sub>AF, max, n</sub>				L <sub>AF, max, nT</sub>			
	RESULT ACCORDING TO	REQUIREMENTS ACCORDING TO			RESULT ACCORDING TO	REQUIREMENTS ACCORDING TO		
	DIN 4109:4 2016-07	DIN 4109:4 2018-01	DIN 4109-5 2020:08	DIN 4109-5 2020:08	VDI 4100: 2012-10	VDI 4100 SSt I	VDI 4100 SSt II	VDI 4100 SSt III
Diagonally underlying room (in the foreign area to be protected)	23 dB(A)	≤30 dB(A) ✓ <b>complied with</b>	≤27dB(A) ✓ <b>complied with</b>	≤25 dB(A) ✓ <b>complied with</b>	19 dB(A)	≤30 dB(A) ✓ <b>complied with</b>	≤27dB(A) ✓ <b>complied with</b>	≤24 dB(A) ✓ <b>complied with</b>
Adjacent room (in a dedicated area)	28 dB(A)	no requirements	no requirements	no requirements	24 dB(A)	EB I ≤35 dB(A) ✓ <b>complied with</b>	EB II ≤30 dB(A) ✓ <b>complied with</b>	no requirements

In the presentation of the results, the highest value is always indicated.

# Fraunhofer IBP test report P-BA 21/2022 Drywall Wavin SiTech+ and Wavin Tigris

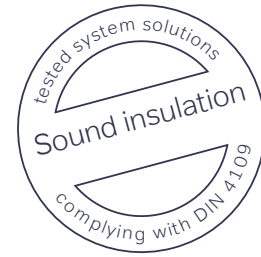
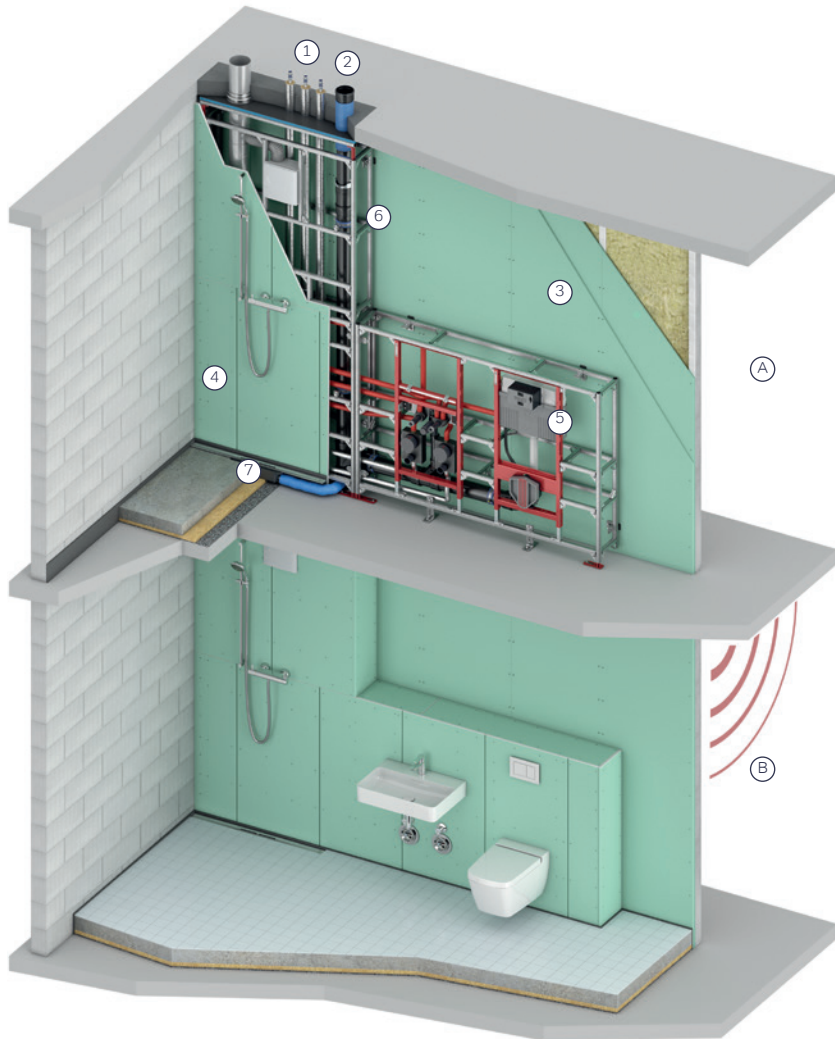

**Rooms**

- (A) Adjacent room, ground floor rear
- (B) Diagonal room underneath, basement rear

**Materials**

- ① Wavin Tigris K5/M5
- ② Wavin SiTech+
- ③ Plasterboard building panels on both sides and two layers with 12.5 mm thickness, filled with 60 mm mineral fibre insulation material
- ④ Plasterboard 18 mm thickness
- ⑤ Curtain wall TECEprofil, WC module with uni cistern
- ⑥ Fastening for wastewater via Wavin system clamp
- ⑦ Shower channel, TECEdrainprofile

**Installation noise according to DIN 4109, DIN 4109-5 and VDI 4100**

MEASUREMENT SITE	$L_{AF, max, n}$				$L_{AF, max, nT}$			
	RESULT ACCORDING TO	REQUIREMENTS ACCORDING TO			RESULT ACCORDING TO	REQUIREMENTS ACCORDING TO		
	DIN 4109:4 2016-07	DIN 4109:4 2018-01	DIN 4109-5 2020:08	DIN 4109-5 2020:08	VDI 4100: 2012-10	VDI 4100 SSt I	VDI 4100 SSt II	VDI 4100 SSt III
Diagonally underlying room (in the foreign area to be protected)	18 dB(A)	≤30 dB(A) ✓ <b>complied with</b>	≤27dB(A) ✓ <b>complied with</b>	≤25 dB(A) ✓ <b>complied with</b>	18 dB(A)	≤30 dB(A) ✓ <b>complied with</b>	≤27dB(A) ✓ <b>complied with</b>	≤24 dB(A) ✓ <b>complied with</b>
Adjacent room (in a dedicated area)	28 dB(A)	no requirements	no requirements	no requirements	27 dB(A)	EB I ≤35 dB(A) ✓ <b>complied with</b>	EB II ≤30 dB(A) ✓ <b>complied with</b>	no requirements

In the presentation of the results, the highest value is always indicated.

# Fraunhofer IBP Test Report P-BA 12/2022

## Wavin SiTech+ and Wavin Tigris solid walls

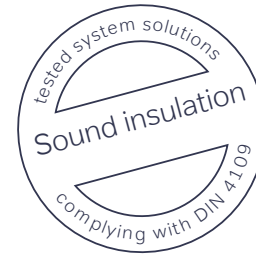
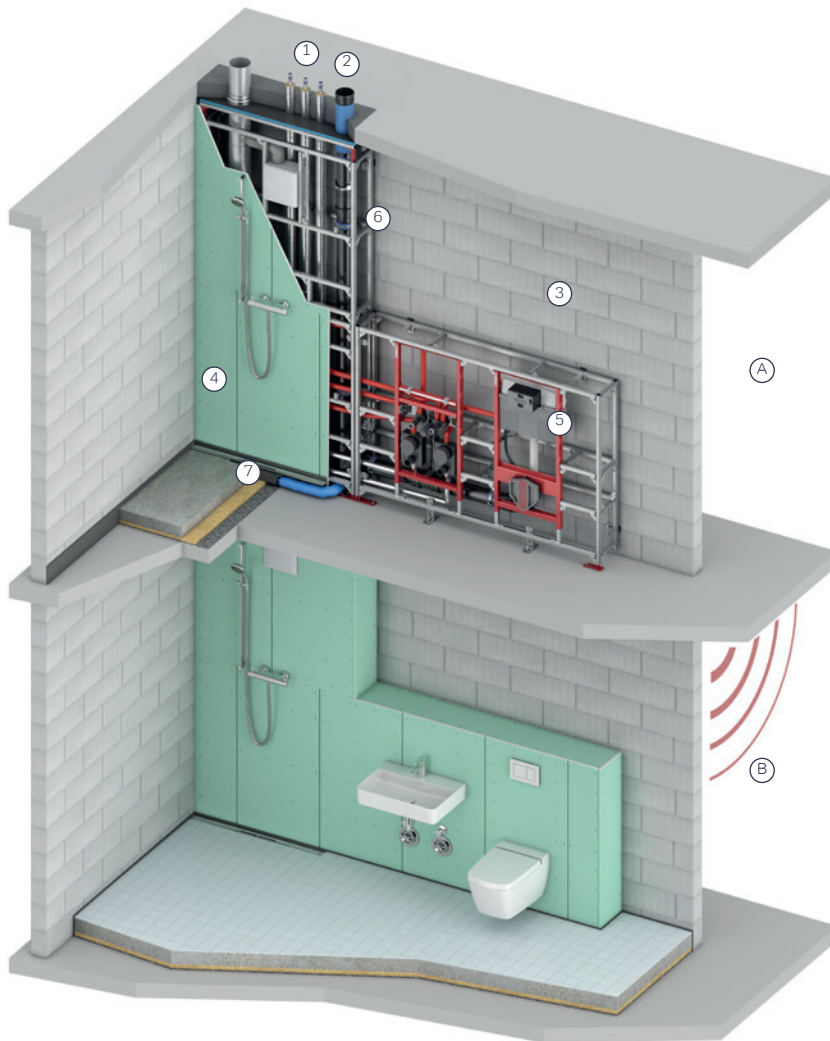

**Rooms**

- (A) Adjacent room, ground floor rear
- (B) Diagonal room underneath, basement rear

**Materials**

- (1) Wavin Tigris K5/M5
- (2) Wavin SiTech+
- (3) Installation wall, solid 220 kg/m<sup>2</sup>
- (4) Plasterboard 18 mm thickness
- (5) Curtain wall TECEprofil, WC module with uni cistern
- (6) Fastening for wastewater via Wavin system clamp
- (7) Shower channel, TECEdrainprofile

**Installation noise according to DIN 4109, DIN 4109-5 and VDI 4100**

MEASUREMENT SITE	$L_{AF, max, n}$				$L_{AF, max, nT}$			
	RESULT ACCORDING TO	REQUIREMENTS ACCORDING TO			RESULT ACCORDING TO	REQUIREMENTS ACCORDING TO		
	DIN 4109:4 2016-07	DIN 4109:4 2018-01	DIN 4109-5 2020:08	DIN 4109-5 2020:08	VDI 4100: 2012-10	VDI 4100 SSt I	VDI 4100 SSt II	VDI 4100 SSt III
Diagonally underlying room (in the foreign area to be protected)	25 dB(A)	≤30 dB(A) ✓ <b>complied with</b>	≤27dB(A) ✓ <b>complied with</b>	≤25 dB(A) ✓ <b>complied with</b>	21 dB(A)	≤30 dB(A) ✓ <b>complied with</b>	≤27dB(A) ✓ <b>complied with</b>	≤24 dB(A) ✓ <b>complied with</b>
Adjacent room (in a dedicated area)	27 dB(A)	no requirements	no requirements	no requirements	24 dB(A)	EB I ≤35 dB(A) ✓ <b>complied with</b>	EB II ≤30 dB(A) ✓ <b>complied with</b>	no requirements

In the presentation of the results, the highest value is always indicated.



# List of abbreviations

$L_{AF}$	Sound pressure level of building services equipment measured with frequency weighting A and time weighting F (FAST) and expressed in dB(A).	$L_{AF,max,nT}$	<b>Maximum standard sound pressure level</b> , measured with frequency weighting A and time weighting F (FAST), referred to a reverberation time of $T_0 = 0.5$ s.
$L_{AF,max}$	Maximal sound pressure level of building services equipment measured with frequency weighting A and time weighting F (FAST) and expressed in dB(A).	$L_{AF,max,nT}$	<b>Average maximum standard sound pressure level</b> , measured with frequency weighting A and time weighting F (FAST), referred to a reverberation time of $T_0 = 0.5$ s.
$L_{AF,max,n}$	Maximum standard sound pressure level, characteristic value for the effect of noise from water installations and other building services on rooms to be protected, measured with frequency weighting A and time weighting F (FAST), related to a reference absorption area $A_0 = 10 \text{ m}^2$ .	$L_{ap}$	<b>Fitting sound level</b> , is evaluated with frequency weighting A, as a characteristic value for the noise behaviour of a fitting.

# Bibliography

1. DIN 4109-1:2018-01 Sound insulation in buildings - Part 1: Minimum requirements
2. DIN 4109-5:2020-08 Sound insulation in buildings - Part 5: Increased requirements
3. VDI 4100:2012-10, Sound insulation between rooms in buildings - Dwellings - Assessment and proposals for enhanced sound insulation between rooms
4. DEGA BR 104 2015-02 Sound insulation in the personal living area
5. DEGA BR 103 2018-01 Sound insulation in residential buildings - Sound insulation certificate
6. Sound insulation: Building acoustics, fundamentals, airborne sound insulation, and impact sound insulation – 2nd edition, Springer Vieweg
7. DIN 4109-36: 2016-07 Sound insulation in buildings - Part 36: Data for verification of sound insulation (component catalogue) - Technical equipment
8. IKZ.de Eavesdropping in the bathroom 19/07/2018





# Discover our broad portfolio at [wavin.com/asia](http://wavin.com/asia)

- Drinking water distribution
- Waste water drainage
- Indoor climate solutions
- Urban climate resilience solutions

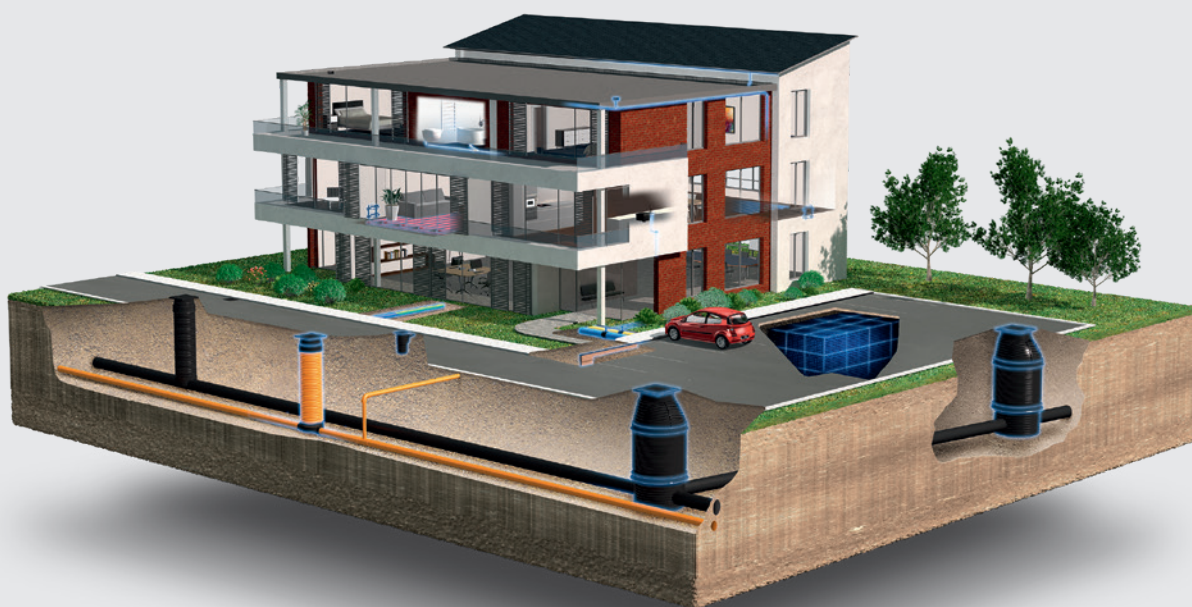

Building &  
Infrastructure



Wavin is part of Orbia, a community of companies working together to tackle some of the world's most complex challenges. We are bound by a common purpose: To Advance Life Around the World.

**Wavin SEA+**  
E-mail [wavinsea@wavin.com](mailto:wavinsea@wavin.com)  
Internet [www.wavin.com/asia](http://www.wavin.com/asia)



Wavin operates a programme of continuous product development, and therefore reserves the right to modify or amend the specification of their products without notice. All information in this publication is given in good faith, and believed to be correct at the time of going to press. However, no responsibility can be accepted for any errors, omissions or incorrect assumptions.

© 2022 Wavin Wavin reserves the right to make alterations without prior notice. Due to continuous product development, changes in technical specifications may change. Installation must comply with the installation instructions.