

Product guide

Wavin PP-R and PP-RCT Pipe Systems

Hot and Cold Water Systems
and Heating Applications





MAY 2023



Wavin is one of the leading companies in the plastic pipe industry in Turkey. Our company offers a wide range of high-quality pipe and fittings system solutions for building and infrastructure. Our company, which has a history of more than half a century, started production in 1971 in Adana. Pilsa Plastik A.Ş. was purchased by Wavin B.V, the largest European company in its own field in the Netherlands in 2008.

In 2012, all Wavin companies joined the Mexichem family which is South America's giant petrochemicals and raw materials producer. Mexichem announced its new name as ORBIA in 2019. ORBIA, with its new changing business structure, provides professional support to its customers with its products and services in 5 main business lines: Building & Infrastructure, Flour, Datacom, Precision Agriculture and Polymer Solutions. With the new structuring of ORBIA, its main mission is to advance life around the world.

In 2019, with the renewed business structure of ORBIA, building & infrastructure business line was started to represent by WAVIN, a single and strong brand across the globe. WAVIN operates in more than 40 countries around the world in 4 main regions: Europe-Middle East-Africa, Asia-Pacific, Latin America and USA-Canada with 12.000 employees.

Wavin is now a global leader in the supply of plastic pipe systems and solutions for both above and below ground applications in projects around the world. Since the 1950s, we have built an unrivalled reputation for continuous innovation, intelligent problem-solving, dedicated technical support and the highest standards.

Wavin Turkey offers traditional products such as PPR-C clean water, PVC wastewater as well as the innovative products such as Tigris Press-fit systems, SiTech+ low noise pipes, Qickstream siphonic rainwater drainage systems, Q-Bic Plus infiltration systems, Tegra plastic manholes etc. to the sector. Wavin Academy which is the first training centre of the sector was opened in 2014 within our factory in Adana, Tens of thousands of visitors from various levels of the mechanical installation sector have been able to increase their expertise by attending training at Wavin Academy since 2014. Our company provides fast service with Adana, Istanbul, Ankara and Izmir offices, distribution centres located in Istanbul and Adana and wide dealers network. In addition to our sales staff, our expert engineers and technical personnel support our customers for the projects.

To get more information about our company and products, please visit our website www.wavin.com.tr and follow us on our social media accounts.

Building Healthy, Sustainable Environments

Our purpose is “Building Healthy, Sustainable Environments” as Wavin in global. To reach that goal one first driver is “Safe and Efficient Water Supply”. We care human health and this is the way how we manage our product portfolio.



PPR Pipes and Fittings used in several applications like potable water, heating and cooling or industrial applications. The PPR system basically based on pipes, full plastic fittings, fittings with inserts, valves and tools.

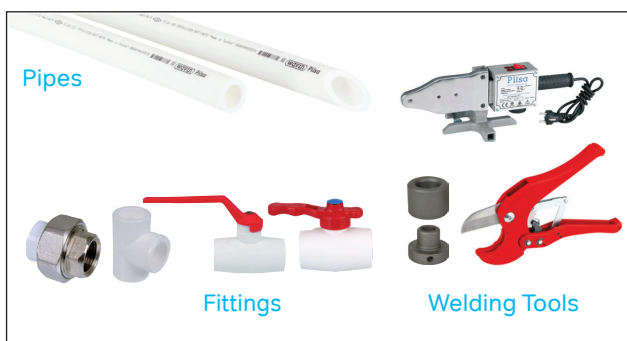

According to the European drinking water directive and hygienic assessment of materials in contact with drinking water, nickel coating is no more applicable for tap water installations. That is why we removed nickel coating from our PPR fittings with metal inserts which are used in drinking water applications globally.

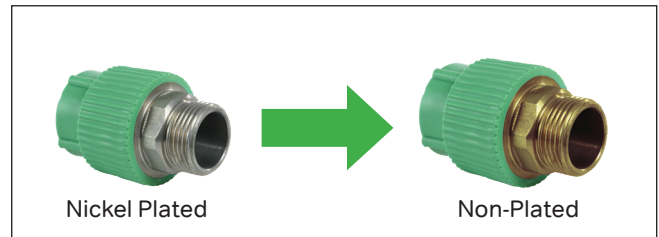

The new PPR Fittings are non-coated brass alloy which is in the acceptable alloy list in 8th revision of 4MS 2017. Metal deactivators are used in the recipe in order to avoid any damage on plastic parts that may be caused by free metal ions from inserts. This application is valid for every color of fitting. PPR Fittings will continue to meet all performance requirements of EN ISO 15874-3 standard. You can reach to international product certifications via Wavin representative.



Extensive Product Range

Above Ground Product Groups:

- PPR&PP-RCT Pipes & Fittings and Composite PPR & PP-RCT Pipes
- PEX and Pert Pipes - Protected PEX and Pert Pipes and Fittings
- OXY PEX and Pert Pipes - Protected OXY PEX and Pert Pipes
- Underfloor Heating and Sentio control systems
- Tigris Press Fitting Systems
- Wavin AS+, SiTech+ and SiTech B1 low noise systems
- Wavin Quickstream Siphonic Roof Drainage System
- U-PVC Soil and Waste System
- HepVO Waterless Trap

Below Ground Product Groups:

- U-PVC Pressure Pipes & Fittings
- PE Pipes (LDPE & HDPE)
- Wavin PE Fittings (Electrofusion - Spigot)
- Wavin Plastic Manholes (Inspection Chambers) & Fittings
- Apollo O-PVC Pressure Pipes
- Separators
- Road Gullies
- Aquacell ve Qbic plus attenuation and infiltration tanks

Why Would You Collaborate With Wavin Turkey?

Wavin Turkey provides the best quality as one of the market leader and:

- ▶ Uses the most appropriate raw material,
- ▶ Has the most advanced high technology,
- ▶ Produces pipes in compliance with Turkish (TS), European (EN) and German(DIN) Standards,
- ▶ Produces pipes not only for water management but also a wide range of fluids.
- ▶ Has qualified technical staff in order to solve your problems.
- ▶ Stands for quality.

Why Would You Prefer Wavin Pipes?

Wavin has got the following advantages:

- ▶ Not dangerous for human life, non-toxic, non-cancerous,
- ▶ Low cost of transportation; loading and unloading
- ▶ Has much longer service life compared to other piping systems,
- ▶ Has high resistance against corrosion,
- ▶ Can easily be connected to any kind of pipe. Due to low cost of plumbing, it has a wide range of applications,
- ▶ Water is one of the most important essential contributing to human life; Wavin pipes provide this vital fluid to your households in an easy and healthy way at a competitive price

WAVIN POLYPROPYLENE PIPES

• Wavin Pipes (PPR-Mono Layer)

- ▶ Superior physical characteristics at 90°C,
- ▶ High chemical resistance,
- ▶ Definite solutions to calcification and corrosion,
- ▶ No bacteria and moss reproduction within the pipes,
- ▶ Light, easy to install and low labor cost of installation,
- ▶ Safe to use various pressurized liquids and gas,
- ▶ No reduction in diameter at welding points,
- ▶ 60°C, 10 bars and 70°C, 8 bar pressure resistance for a service life of 50 years.
- ▶ Can be used in drinking water systems and has a quality certificate issued by the Ministry of Health and Hygiene-Institute

• Wavin Pipes (PP-RCT Mono Layer)

- ▶ Wavin PP-RCT Pipes are made of the raw material PP-RCT which is new generation polypropylene designed for hot and cold water systems.
- ▶ It is the better pipe with higher flow rate, improved pressure resistance and easier to handle.
- ▶ It has improved pressure resistance at higher temperatures for long term period.
- ▶ It has 37 % larger inner flow area
- ▶ Larger inner bore and better flow rates
- ▶ Wavin PP-RCT can be used with all standard Wavin PP-R fittings
- ▶ Available in different color options

• Glass Fiber Reinforced Composite Pipes (PPR-Multi Layer)

- ▶ GFR PPR pipe is multilayered and elongates less during the heat differences.
- ▶ Unlike aluminium foiled pipes; there is no need to shave the end of the pipe. This provides ease of install.
- ▶ The linear coefficient of thermal expansion is very low (0,035mm/mK); accordingly greater stability. In comparison to standard pipes total quantity of clamps used is less, therefore total expenses reduces.
- ▶ Due to the low thermal conductivity of glass fiber itself, thermal conductivity coefficient of multilayer pipe is lower than solid wall pipe. Less insulation is necessary.
- ▶ It does not cause a change in the color, smell or the taste of water. It has a hygienic structure. Can easily be used for hot and cold water systems

• Basalt Fiber Composite Pipes (PP-RCT Multi Layer)

- ▶ Pipes are multilayer and made of the raw material PP-RCT which is new generation polypropylene designed for hot and cold water systems.
- ▶ Basalt fiber is made of pulping melted basalt stones of suitable composition.
- ▶ It is very durable and flexible and used in many different industries.
- ▶ Properties of basalt fiber significantly exceed glass fiber.
- ▶ Manufacturing of basalt fiber is very ecological and 100% recyclable
- ▶ 4-x lower linear thermal expansion than solid wall pipes,
- ▶ No need to shave before welding
- ▶ Higher pressure resistance at higher temperatures by up to 50%
- ▶ Temperature resistance up to 90°C
- ▶ Higher flow rate by up to 20%

PHYSICAL AND MECHANICAL PROPERTIES OF RAW MATERIAL - PP-R

Properties	Testing Conditions	Unit	Testing Method	Result
MRS Classification	20°C, extrapolation 50 years	MPa	ISO 9080	10
Density	23°C	g/cm ³	ISO 1183	0,89 - 0,91
Melting Flow Index MFI	190°C, 5 kg	g/10dk g/10min	ISO 1133	0,4 - 0,6
	230°C, 2,16 kg			0,2 - 0,5
	230°C, 5 kg			0,8 - 1,3
Tensile Stress at Yield	23°C, 50 mm/dk 50 mm/min	MPa	ISO 527	23 - 28
Tensile Strain at Yield	23°C, 50 mm/dk 50 mm/min	%	ISO 527	min %10
Elasticity Modulus	23°C, 1 mm/dk 1 mm/min	MPa	ISO 527	800 - 1000
Charpy Notched Impact Strength	0°C	kJ/m ²	ISO 179	>3,5
Thermal Conductivity	-	W/(m K)	DIN 52612	0,24
Coefficient of Thermal Expansion (0°C/90°C)	-	1/K	DIN 53752	1,5*10 ⁻⁴

ISOTHERMAL MECHANICAL STRENGTH GRAPHIC FOR PP-R

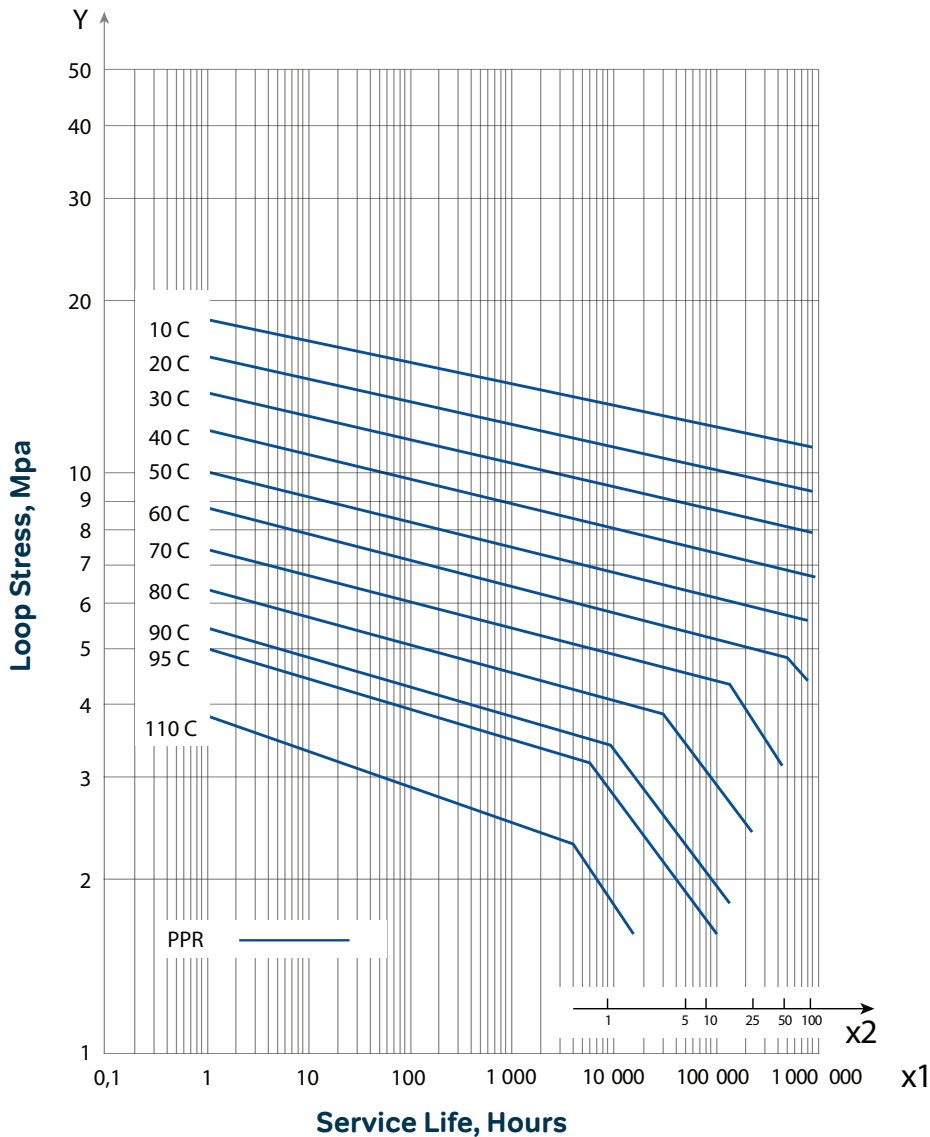

PHYSICAL AND MECHANICAL PROPERTIES OF RAW MATERIAL - PP-RCT

Properties	Testing Conditions	Unit	Testing Method	Result
MRS Classification	20°C, extrapolation 50 years	MPa	ISO 9080	11,2
CRS Classification	70°C, extrapolation 50 years	MPa	ISO 9080	5,3
Density	23°C	g/cm ³	ISO 1183	0,89 - 0,91
Melting Flow Index MFI	190°C, 5 kg	g/10dk g/10min	ISO 1133	0,4 - 0,6
	230°C, 2,16 kg			0,2 - 0,5
	230°C, 5 kg			0,8 - 1,3
Tensile Stress at Yield	23°C, 50 mm/dk 50 mm/min	MPa	ISO 527	23 - 28
Tensile Strain at Yield	23°C, 50 mm/dk 50 mm/min	%	ISO 527	min %10
Elasticity Modulus	23°C, 1 mm/dk 1 mm/min	MPa	ISO 179	800 - 900
Charpy Notched Impact Strength	0°C	kJ/m ²	ISO 179	9,5
Izod Notched Impact Strength	0°C	kJ/m ²	DIN 52612	17
Thermal Conductivity	-	W/(m K)	DIN 52612	0,24
Coefficient of Thermal Expansion (0°C/90°C)	-	1/K	DIN 53752	1,5*10 ⁻⁴

ISOTHERMAL MECHANICAL STRENGTH GRAPHIC FOR PP-RCT

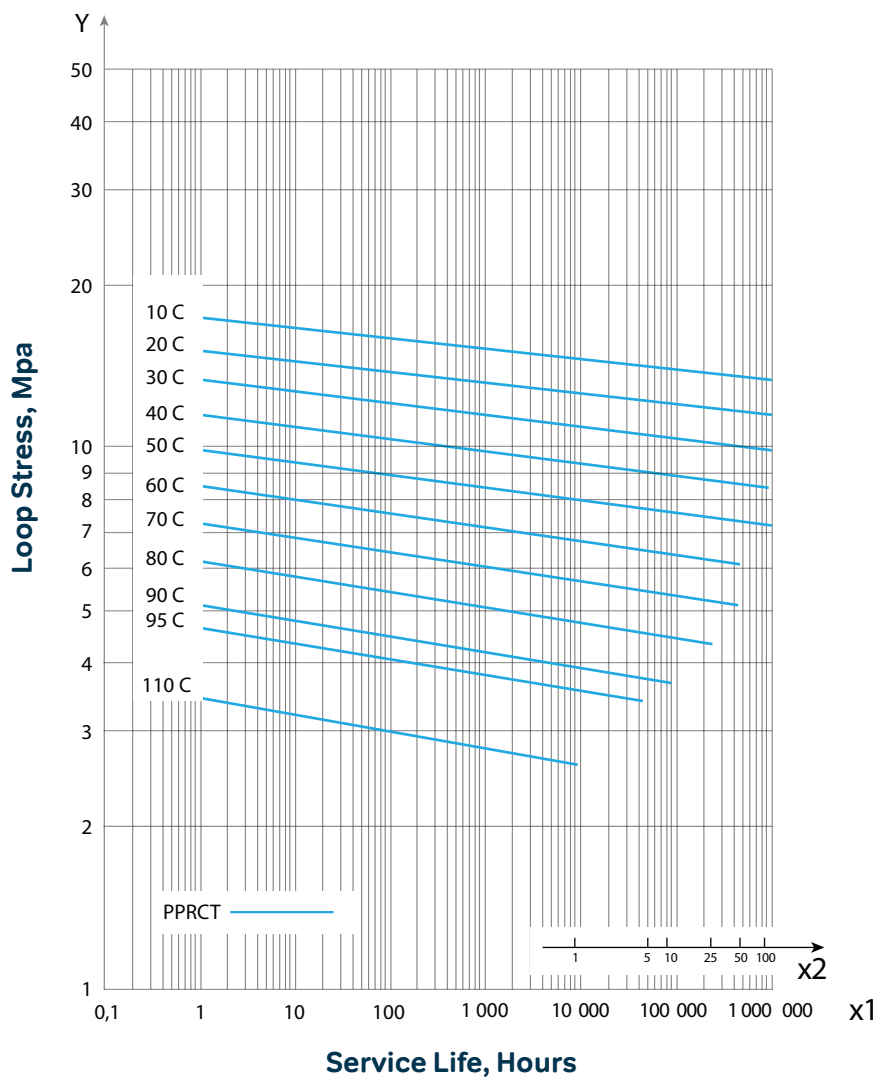

OPERATING PARAMETERS FOR PP-R & PP-RCT PIPES

		PP-R Pipe Glass Fiber Reinforced PP-R Pipe			PP-RCT Pipe / Basalt Reinforced PP-RCT Pipe		
		Operating Pressure			Operating Pressure		
Temp °C	Life (year)	S 2,5 SDR 6	S 3,2 SDR 7,4	S 5 SDR 11	S 3,2 SDR 7,4	S 4 SDR 9	S 5 SDR 11
10	1	35,1	27,8	17,5	30,2	24,0	19,0
	5	33,0	26,2	16,5	29,3	23,2	18,4
	10	32,2	25,6	16,1	28,9	22,9	18,2
	25	31,1	24,7	15,6	28,4	22,5	17,9
	50	30,3	24,1	15,2	28,0	22,2	17,7
	100	29,6	23,5	14,8	27,6	21,9	17,4
20	1	29,9	23,7	15,0	26,3	20,9	16,6
	5	28,1	22,3	14,1	25,4	20,2	16,0
	10	27,4	21,7	13,7	25,1	19,9	15,8
	25	26,4	21,0	13,2	24,6	19,6	15,5
	50	25,7	20,4	12,9	24,3	19,3	15,3
	100	25,0	19,9	12,5	24,0	19,0	15,1
30	1	25,4	20,2	12,7	22,7	18,1	14,3
	5	23,8	18,9	11,9	22,0	17,4	13,9
	10	23,2	18,4	11,6	21,7	17,2	13,6
	25	22,3	17,7	11,2	21,2	16,9	13,4
	50	21,7	17,2	10,9	20,9	16,6	13,2
	100	21,1	16,8	10,6	20,6	16,4	13,0
40	1	21,6	17,1	10,8	19,6	15,5	12,3
	5	20,2	16,0	10,1	18,9	15,0	11,9
	10	19,6	15,5	9,8	18,6	14,7	11,7
	25	18,8	15,0	9,4	18,2	14,4	11,5
	50	18,3	14,5	9,2	17,9	14,2	11,3
	100	17,8	14,1	8,9	17,6	14,0	11,1
50	1	18,2	14,5	9,1	16,7	13,3	10,5
	5	17,0	13,5	8,5	16,4	12,8	10,1
	10	16,5	13,1	8,2	15,8	12,6	10,0
	25	15,9	12,6	7,9	15,5	12,3	9,7
	50	15,4	12,2	7,7	15,2	12,1	9,6
	100	14,9	11,8	7,5	15,0	11,9	9,4
60	1	15,4	12,2	7,7	14,2	11,2	8,9
	5	14,3	11,3	7,1	13,6	10,8	8,6
	10	13,9	11,0	6,9	13,4	10,6	8,4
	25	13,3	10,5	6,6	13,1	10,4	8,2
	50	12,9	10,2	6,4	12,8	10,2	8,1
	70	1	12,9	10,3	6,5	11,9	9,4
5		12,0	9,5	6,0	11,4	9,1	7,2
10		11,6	9,2	5,8	11,2	8,9	7,0
25		10,0	8,0	5,0	10,9	8,7	6,9
50		8,5	6,7	4,2	10,7	8,5	6,8
80		1	10,8	8,6	5,4	9,9	7,9
	5	9,6	7,6	4,8	9,5	7,5	6,0
	10	8,1	6,4	4,0	9,3	7,4	5,9
	25	6,5	5,1	3,2	9,1	7,2	5,7
	95	7,6	1	6,1	3,8	7,4	5,9
5,2		5	4,1	2,6	7,1	5,6	4,4
4,3		10	(3,4)	(2,2)	(6,9)	(5,5)	(4,3)

*Safety Factor (C): 1,5

Pipes and fittings

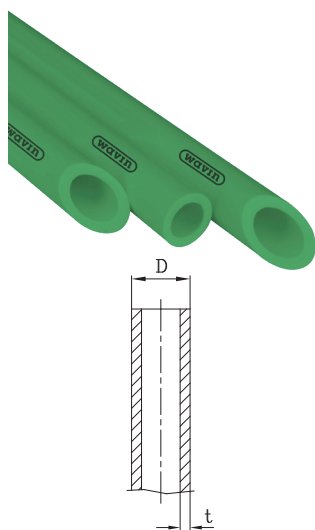

Wavin PPR Pipe (PPR-4mt)

DN	t (mm) 10 Bar	t (mm) 16 Bar	t (mm) 20 Bar	s5 SDR 11 PN10	s3,2 SDR 7,4 PN16	s2,5 SDR 6 PN20	Bundle
20	1,9	2,8	3,4	3032849	3040251	3033265	25
25	2,3	3,5	4,2	3032850	3040252	3033266	20
32	2,9	4,4	5,4	3032694	3040253	3033203	10
40	3,7	5,5	6,7	3032851	3040254	3033267	5
50	4,6	6,9	8,3	3032852	3040255	3033268	5
63	5,8	8,6	10,5	3032853	3040256	3032858	3
75	6,8	10,3	12,5	3033218	3040257	3033221	2
90	8,2	12,3	15,0	3033219	3040258	3032775	2
110	10,0	15,1	18,3	3032695	3040259	3033204	1
125	11,4	17,1	20,8	3032696	3040260	3032699	1

Wavin GlassFiber Multilayer Pipe (PPR-4mt)

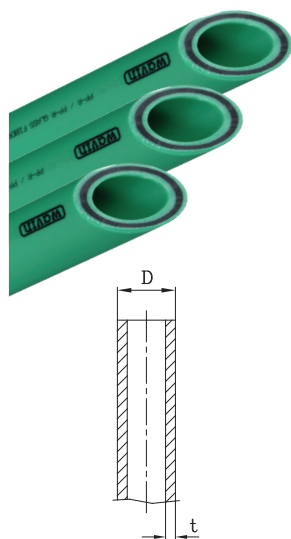

DN	t (mm) 20 Bar	t (mm) 25 Bar	s 3,2 SDR 7,4 PN20	s 2,5 SDR 6 PN 25	Bundle
20	2,8	3,4	3052128	3052129	25
25	3,5	4,2	3052130	3052131	20
32	4,4	5,4	3052132	3052133	10
40	5,5	6,7	3052134	3052135	5
50	6,9	8,3	3082445	3052136	5
63	8,6	10,5	3082444	3052137	3
75	10,3	12,5	3082443	3072615	2
90	12,3	15,0	3082442	3072616	2
110	15,1	18,3	3082441	3081227	1
125	17,1	20,8	3082440	3052138	1

Wavin PP-RCT (4mt)

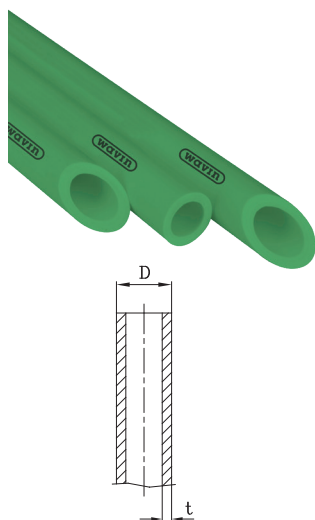

DN	t (mm)	s 4 SDR 9 PN 22	Bundle
20	2,3	3065542	25
25	2,8	3065543	20
32	3,6	3065544	10
40	4,5	3065545	5
50	5,6	3065546	5
63	7,1	3065547	3
75	8,4	3065548	2
90	10,1	3065549	2
110	12,3	3065550	1
125	14	3065551	1

Wavin BasaltFiber Multilayer Pipe (PP-RCT-4mt)

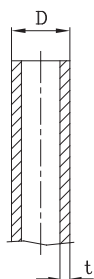

DN	t (mm)	s 4 SDR 9 PN 22	s 3,2 SDR 7,4 PN 25	Bundle
20	2.8		3052419	25
25	3.5		3052420	20
32	4.4		3052421	10
40	5.5		3052422	5
50	6.9		3052423	5
63	8.6		3052424	3
75	8.4	3052425		2
90	10.1	3052426		2
110	12.3	3052427		1
125	14.0	3052428		1

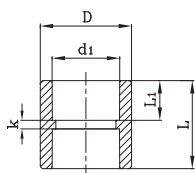

Socket

DN	Sap Code	Bag	Box	d (mm)	L1(min.) (mm)	D (mm)	L (mm)	k (mm)
20	3033270	50	600	19,50	14,50	28	33	4
25	3033271	40	400	24,50	16,00	34	37	4
32	3033272	20	240	31,50	18,00	42,5	41	4
40	3033273	15	120	39,40	20,50	53	46	4,5
50	3033274	10	100	49,40	23,50	66	52	4,5
63	3032865	6	48	62,50	27,50	83	60	4,5
75	3032866	6	30	74,70	30,00	100	65	5
90	3032776	1	24	89,20	33,00	120	71,5	6
110	3033275	1	10	109,00	37,00	146	80	6
125	3033276	1	10	124,60	40,00	167	86	6

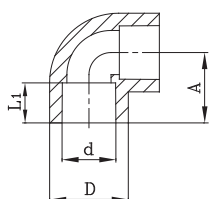

Elbow (90°)

DN	Sap Code	Bag	Box	d (mm)	L1(min.) (mm)	D (mm)	A (mm)
20	3032870	50	450	19,5	14,5	28	25,5
25	3033222	50	300	24,5	16	33	29,5
32	3033278	25	150	31,5	18	43,5	35
40	3033279	10	80	39,4	20,5	53	41,5
50	3033280	5	40	49,4	23,5	67	50
63	3032874	5	25	62,5	27,5	83,5	60
75	3033281	3	15	74,7	30	100	68
90	3033282	1	8	89,2	33	120	78,5
110	3033283	1	4	109	37	147	92,5
125	3033284	1	4	124,6	40	168	102

Elbow (45°)

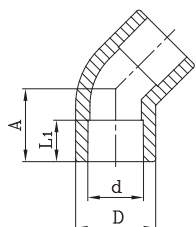

DN	Sap Code	Bag	Box	d (mm)	L1(min.) (mm)	D (mm)	A (mm)
20	3033286	50	400	19,5	14,5	26,5	20
25	3032881	50	250	24,5	16	33,5	22
32	3033287	20	120	31,5	18	43,5	32
40	3033288	10	100	39,4	20,5	52,5	31
50	3033289	8	48	49,4	23,5	68	35
63	3032780	4	24	62,5	27,5	84	42,5
75	3032885	3	18	74,7	30	100	47

Elbow with Reducer

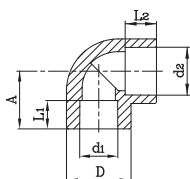

DN	Sap Code	Bag	Box	d1 (mm)	L1(min.) (mm)	d2 (mm)	L2(min.) (mm)	D (mm)	A (mm)
25-20	3051587	30	300	19,5	14,5	25	16	33	29,5

Elbow (Female-Male) 90°

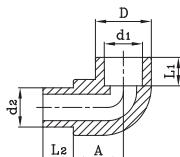

DN	Sap Code	Bag	Box	d1 (mm)	L1(min.) (mm)	d2 (mm)	L2(min.) (mm)	D (mm)	A (mm)
20	3033285	50	500	19,5	14,5	20	15	28,5	25
25	3033223	30	300	24,5	16	25	15,5	33,5	29,5
25/20	3033224	30	300	24,5	16	20	15,5	33	29,5

Bend

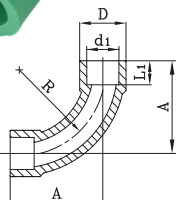

DN	Sap Code	Bag	Box	d1 (mm)	L1(min.) (mm)	D (mm)	L2(min.) (mm)	L (mm)
25	3079934	20	180	24,5	16	35	63,5	88

Tee

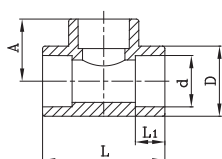

DN	Sap Code	Bag	Box	d (mm)	L1(min.) (mm)	D (mm)	L (mm)	A (mm)
20	3033290	30	240	19,5	14,5	27	51,5	26
25	3033291	25	150	24,5	16	33	63	30
32	3032889	15	90	31,5	18	43	72	36
40	3032890	5	50	39,4	20,5	53	85	43,5
50	3033292	4	32	49,4	23,5	66,5	100	50
63	3033293	3	18	62,5	27,5	84,5	119,5	60
75	3033294	2	12	74,7	30	100	130	73
90	3033295	1	6	89,2	33	120	158	79
110	3033296	1	4	109	37	146	186	93
125	3033297	1	3	124,6	40	167	208	103,5

Cross Tee

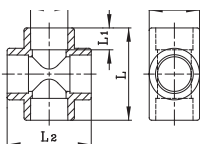

DN	Sap Code	Bag	Box	d (mm)	L1(min.) (mm)	D (mm)	L (mm)	L2 (mm)
20	3033319	25	200	19,5	14,5	26,5	51	51
25	3033320	15	150	24,5	16	33	60	60
32	3032925	10	90	31,5	18	42,5	70	70
40	3033321	5	50	39,4	20,5	53	84	84
50	3033225	3	24	49,4	23,5	66,5	103,5	103,5

Manchon Union PN 10

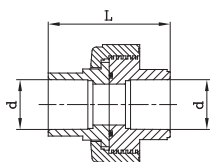

DN	Sap Code	Bag	Box	d (mm)	L (mm)
20	3040972	15	180	19,5	41
25	3033341	10	120	24,5	51
32	3033342	5	60	31,5	63
40	3033343	5	40	39,4	71
50	3032951	4	32	49,4	74

Unequal Tee

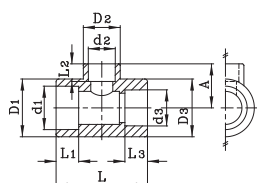

D1	D2	D3	Sap Code	Bag	Box	d1 (mm)	L1(min) (mm)	D1 (mm)	d2 (mm)	L2(min) (mm)	D2 (mm)	d3 (mm)	L3(min) (mm)	D3 (mm)	L (mm)	A (mm)
20x25x20			3040002	25	150	19,5	14,5	33	24,5	16	33,5	19,5	14,5	33	65	37,5
25x20x20			3039999	25	150	24,5	16	35	19,5	14,5	28	19,5	14,5	28	53	27,5
25x20x25			3040000	25	150	24,5	16	33	19,5	14,5	26,5	24,5	16	33	55	28,5
25x25x20			3033298	25	150	24,5	18	33,5	24,5	16	33,5	19,5	14,5	33,5	65	35,5
32x20x20			3051556	15	90	31,5	18	42,5	19,5	14,5	42,5	19,5	14,5	42,5	73,5	40,5
32x20x25			3045670	15	90	31,5	18	43	19,5	14,5	42,5	24,5	16	43	73,5	40,5
32x20x32			3033300	15	90	31,5	18	42,5	19,5	14,5	27	31,5	18	42,5	60	31,5
32x25x20			3045671	15	90	31,5	18	42,5	24,5	16	42,5	19,5	14,5	42,5	73,5	40
32x25x25			3033302	15	90	31,5	18	43	24,5	16	43	24,5	16	43	66	40
32x25x32			3033301	15	90	31,5	18	43	24,5	16	34	31,5	18	43	103	35
32x50x32			3032902	4	32	31,5	18	65	49,4	23,5	65	31,5	18	65	65,5	54,5
40x20x40			3032903	5	50	39,4	20,5	53	19,5	14,5	33	39,4	20,5	53	70	38,5
40x25x40			3033303	5	50	39,4	20,5	53	24,5	16	33	39,4	20,5	53	70	38,5
40x32x40			3033304	5	50	39,4	20,5	53	31,5	18	43	39,4	20,5	53	80	41
40x50x40			3033305	4	32	39,4	20,5	66	49,4	23,5	65,5	39,4	20,5	66	103	54,5
50x20x50			3033307	4	32	49,4	23,5	66,5	19,5	14,5	33	49,4	23,5	66,5	85	44
50x25x50			3033308	4	32	49,4	23,5	66,5	24,5	16	33	49,4	23,5	66,5	85	44
50x32x32			3045674	4	32	49,4	23,5	66,5	31,5	18	65,5	31,5	18	66,5	103	55,5
50x32x40			3045676	5	50	49,4	23,5	66	31,5	18	65,5	39,4	20,5	66	103	54,5
50x32x50			3033309	4	32	49,4	23,5	65	31,5	18	51	49,4	23,5	65	90	49,5
50x40x32			3045675	4	32	49,4	23,5	66,5	39,4	20,5	66	31,5	18	66,5	103	55,5
50x40x40			3045672	4	32	49,4	23,5	66	39,4	20,5	65,5	39,4	20,5	66	104	55,5
50x40x50			3033306	4	32	49,4	23,5	65	39,4	20,5	52	49,4	23,5	65	90	49,5
50x50x32			3045677	4	32	49,4	23,5	66	49,4	23,5	66	31,5	18	66	103,5	55
50x50x40			3045673	4	32	49,4	23,5	65,5	49,4	23,5	65	39,4	20,5	65,5	103,5	54,5
63x20x63			3041940	2	20	62,5	27,5	84	19,5	14,5	26,5	62,5	27,5	84	80	52
63x25x63			3033310	2	20	62,5	27,5	84	24,5	16	33	62,5	27,5	84	85	52
63x32x63			3033311	2	20	62,5	27,5	84	31,5	18	42,5	62,5	27,5	84	91	52
63x40x63			3032913	2	20	62,5	27,5	83,5	39,4	20,5	53	62,5	27,5	83,5	101	54
63x50x63			3033312	2	20	62,5	27,5	83,5	49,4	23,5	66	62,5	27,5	83,5	112	57
75x20x75			3032915	1	12	74,7	30	100	19,5	14,5	33	74,7	30	100	130	60
75x25x75			3033313	1	12	74,7	30	100	24,5	16	33	74,7	30	100	130	60
75x32x75			3033314	1	12	74,7	30	100	31,5	18	53	74,7	30	100	130	60
75x40x75			3033315	1	12	74,7	30	100	39,4	20,5	53	74,7	30	100	130	60
75x50x75			3032919	1	12	74,7	30	100	49,4	23,5	83,5	74,7	30	100	130	68
75x63x75			3033316	1	12	74,7	30	100	62,5	27,5	83,5	74,7	30	100	130	68
90x75x90			3033317	1	8	89,2	33	120	74,7	30	120	89,2	33	120	158	79
110x90x110			3033318	1	4	109	37	146	89,2	33	146	109	37	146	186	93

Female-Female Reducer

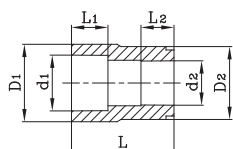

DN	Sap Code	Bag	Box	d1 (mm)	L1 (min.) (mm)	d2 (mm)	L2 (min) (mm)	D1 (mm)	D2 (mm)	L (mm)
25/20	3033228	30	300	24,5	16	19,5	14,5	35	32,5	39
32/20	3051568	25	250	31,5	18	19,5	14,5	43	41	48,5
32/25	3032946	25	250	31,5	18	24,5	16	43	41	48,5

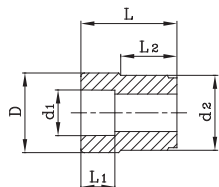

Female-Male Reducer

DN	Sap Code	Bag	Box	d1 (mm)	L1(min) (mm)	d2 (mm)	L2(min.) (mm)	D (mm)	L (mm)
25/20	3040003	40	560	19,5	14,5	25	18	29	39
32/20	3033227	30	300	19,5	14,5	32	13,5	35	39
32/25	3033226	30	300	24,5	16	32	15,5	35	39,5
40/20	3033323	30	240	19,5	14,5	29	25	40	47,5
40/25	3033324	30	240	24,5	16	34	24,5	40	48
40/32	3033325	20	200	31,5	18	40	27,5	42	47
50/20	3033326	20	200	19,5	14,5	29	23,5	50	48
50/25	3033327	25	200	24,5	16	34	23,5	50	49,5
50/32	3033328	15	150	31,5	18	42	23,5	50,5	47,5
50/40	3033329	10	120	39,4	20,5	50	24,5	53,5	48
63/25	3033330	10	120	24,5	16	34	28	63	56,5
63/32	3033331	10	120	31,5	18	43	28,5	63	57,5
63/40	3033332	5	80	39,4	20,5	53	28	63	53
63/50	3033333	5	60	49,4	23,5	63	28	67	53
75/50	3033334	5	50	49,4	23,5	67	31	75,5	61,5
75/63	3033335	5	40	62,5	27,5	75	26	84,5	67
90/63	3033336	4	36	62,5	27,5	84	28	90	76,5
90/75	3032784	2	24	74,7	30	90	33	97	81,5
110/63	3033337	1	18	62,5	27,5	84	32,5	110	88
110/75	3033338	1	18	74,7	30	100	32,5	110	91,5
110/90	3040976	1	18	89,2	33	110	32,5	119	93,5
125/110	3033339	1	13	109	37	125	37	148	102

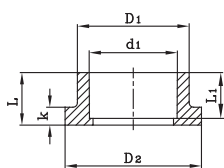

Flange Adaptor

DN	Sap Code	Bag	Box	d (mm)	L1(min.) (mm)	D1 (mm)	D2 (mm)	L (mm)	k (mm)
40	3033344	25	250	39,4	20,5	50,5	62	24	8,5
50	3033345	15	150	49,4	23,5	61,5	73,5	27	8,5
63	3033346	10	80	62,5	27,5	77	90,5	31,5	8
75	3033347	4	36	74,7	30	90,5	106	38	16
90	3033348	4	36	89,2	33	109	124,5	42,5	18
110	3033349	2	20	109	37	132	150,5	50	21
125	3033350	1	12	124,6	40	164	185	62	20

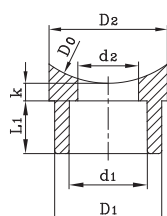

Saddle

DN	Sap Code	Bag	Box	d0 (mm)	d1 (mm)	L1(min.) (mm)	d2 (mm)	D1 (mm)	D2 (mm)	k (mm)
63/20	3033354	50	600	63	19,5	14,5	17	28,5	37	6
63/25	3033355	50	600	75	19,5	14,5	17	28,5	37	6
75/20	3033356	50	600	90	19,5	14,5	17	28,5	37	6
75/25	3033357	50	600	110	19,5	14,5	17	28,5	37	6
90/20	3033358	50	600	63	24,5	16	19	33,5	37,5	6
90/25	3033359	50	600	75	24,5	16	19	33,5	37,5	6
110/20	3033360	50	600	90	24,5	16	19	33,5	37,5	6
110/25	3033361	50	600	110	24,5	16	19	33,5	37,5	6

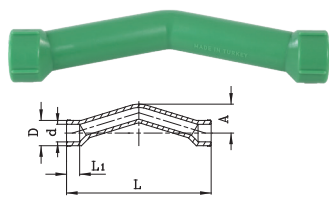

Crossover Bridge

DN	Sap Code	Bag	Box	d1 (mm)	L1(min.) (mm)	D (mm)	L (mm)	A (mm)
20	3051566	15	150	19,5	14,5	28,5	160	33
25	3051567	10	100	24,5	16	33	194	40
32	4056718	4	56	31,5	18	46	216	49

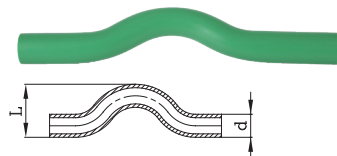

Bridge

DN	Sap Code	Bag	Box	d (mm)	L (mm)
20	3032960	15	135	20	45
25	3033352	10	90	25	55
32	3032786	5	45	32	69
40	3033353	3	27	40	85

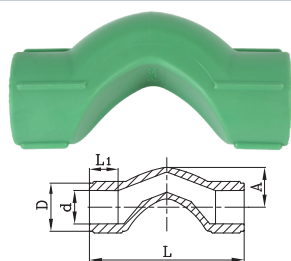

Short Bridge

DN	Sap Code	Bag	Box	d (mm)	L1(min.) (mm)	D (mm)	A (mm)	L (mm)
20	4047834	30	240	19,5	14,5	28	23	90
25	4047835	25	150	24,5	16	33,5	31	96

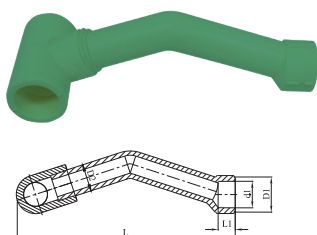

Tee w/ V Type Bridge

DN	Sap Code	Bag	Box	d1 (mm)	L1(min.) (mm)	D1 (mm)	D2 (mm)	L (mm)
20/20/20	3074995	10	100	19,5	14,5	28	20	160
25/25/25	3074996	10	100	24,5	16	32,5	25	203
25/20/25	3074997	5	50	19,5	14,5	28	20	165
32/25/32	3074998	5	50	24,5	16	32,5	25	212

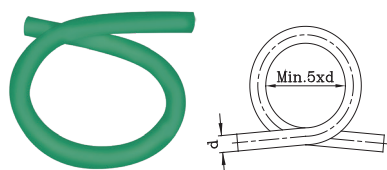

Omega

DN	Sap Code	Bag	Box	d (mm)
20	3039995	5	25	20
25	3039996	3	15	25
32	3041144	1	8	32
40	3041145	1	4	40

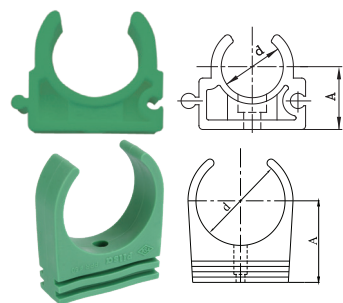

Clips

DN	Sap Code	Bag	Box	d (mm)	A (mm)
20	3033503	100	1200	20,5	19
25	3033504	80	960	25,5	22
32	3033505	50	500	32,5	25
40	3033491	40	320	40,5	29
50	3033506	25	200	48,5	44

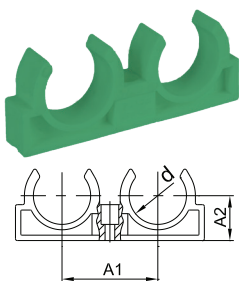

Double Clips

DN	Sap Code	Bag	Box	d (mm)	A1 (mm)	A2 (mm)
20	3039993	50	500	20	38	17,5
25	3039994	40	320	25	44,5	19,5
32	3042396	25	200	32	53,5	25



Manifold

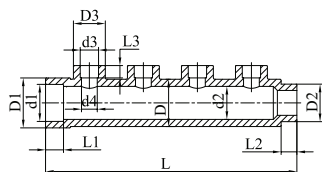

DN	Sap Code	d1 (mm)	L1 (mm)	D1 (mm)	D2 (mm)	L2 (mm)	d2 (mm)	d3 (mm)	D3 (mm)	L3 (mm)	d4 (mm)	D (mm)	L (mm)
50x25	3081247	49,4	23,5	66,5	50	21	44	24,5	42,5	16,0	21	63	335
50x32	3081551	49,4	23,5	66,5	50	21	44	31,5	42,5	18,0	28	63	335



End Cap

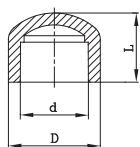

DN	Sap Code	Bag	Box	d (mm)	D (mm)	L (mm)
20	3033363	100	800	19,5	28,5	25,5
25	3033494	80	640	24,5	34,5	29
32	3033495	50	400	31,5	43	32
40	3033496	25	200	39,4	53,5	37,5
50	3033367	10	100	49,4	67	43,5
63	3033368	10	80	62,5	85	52
75	3033369	6	48	74,7	100,5	58
90	3033497	4	32	89,2	121	64
110	3033498	2	16	109	146,5	71,5



Male Threaded End Cap

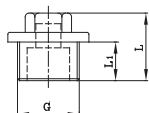

DN	Sap Code	Bag	Box	L1 (mm)	L (mm)	G (mm)
20x1/2"	3033499	100	1000	11	34	1/2"
25x3/4"	3033500	80	640	11	31	3/4"
32x1"	3033501	50	400	20	40	1"



Female Threaded Adaptor

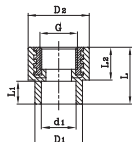

DN	Sap Code	Bag	Box	d1 (mm)	L1 (min) (mm)	D1 (mm)	D2 (mm)	L2 (mm)	L (mm)	G (mm)
20x1/2	3033230	20	320	19,5	14,5	28,5	38,5	24	40,5	1/2"
20x3/4	3033000	20	240	19,5	14,5	29	42,5	24	40	3/4"
25x1/2	3033391	25	250	24,5	16	33,5	38	24	40,5	1/2"
25x3/4	3033392	20	280	24,5	16	33	42,5	24	40,5	3/4"
32x3/4	3033393	10	120	31,5	18	43	45,5	24,5	44	3/4"
32x1	3033394	10	120	31,5	18	43	53	28	47,5	1"

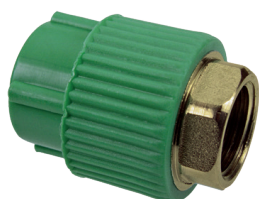

Female Threaded Adaptor (Hexagonal Shaped)

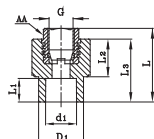

DN	Sap Code	Bag	Box	d1 (mm)	L1 (min) (mm)	D1 (mm)	L2 (mm)	L3 (mm)	L (mm)	G (mm)
40x1 1/4	3033395	10	40	39,4	20,5	54	25,5	47	61	1-1/4"
50x1 1/2	3033231	4	24	49,4	23,5	68	29	53,5	67,5	1-1/2"
63x2	3033232	2	14	62,5	27,5	84	28,5	55	73	2"
75x2 1/2	3033233	2	12	74,7	30	100	30	59,5	78	2-1/2"
90x3	3033396	1	5	89,2	33	120,5	44	75,5	92	3"
110x4	3033397	1	4	109	37	147	48	84	102	4"

Male Threaded Adaptor

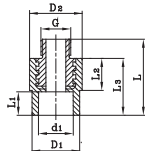

DN	Sap Code	Bag	Box	d1 (mm)	L1(min) (mm)	D1 (mm)	D2 (mm)	L (mm)	L2 (mm)	L3 (mm)	G (mm)
20x1/2	3033381	25	250	19,5	14,5	28,5	35	53	24	40	1/2"
20x3/4	3033382	20	200	19,5	14,5	29	42,5	53	23,5	40	3/4"
25x1/2	3033383	15	240	24,5	16	34	39	53	23,5	40	1/2"
25x3/4	3033384	15	150	24,5	16	33	42	53	24	40	3/4"
32x3/4	3033385	10	100	31,5	18	43	45	57	24,5	44	3/4"
32x1	3033386	10	100	31,5	18	43	52,5	62,5	28	47	1"

Male Threaded Adaptor (Hexagonal Shaped)

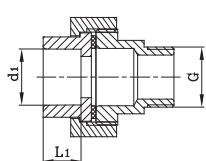

DN	Sap Code	Bag	Box	d1 (mm)	L1(min) (mm)	D1 (mm)	L2 (mm)	L3 (mm)	L (mm)	G (mm)
40x1 1/4"	3033387	5	25	39,4	20,5	54	25	47	81	1-1/4"
50x1 1/2"	3033388	2	16	49,4	23,5	68	29	53,5	87,5	1-1/2"
63x2"	3033389	1	10	62,5	27,5	84	28,5	55	98	2"
75x2 1/2"	3040973	1	6	74,7	30	100	30	59,5	105	2-1/2"
90x3"	3040974	1	5	89,2	33	120,5	43,5	76	118	3"
110x4"	3040975	1	3	109	37	147	48	84,5	129,5	4"

Female Threaded Tee

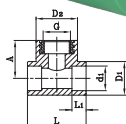

DN	Sap Code	Bag	Box	d1 (mm)	L1(min) (mm)	D1 (mm)	D2 (mm)	A (mm)	L (mm)	G (mm)
20x1/2	3033406	25	200	19,5	14,5	27	38,5	35	51,5	1/2"
20x3/4	3033407	20	140	19,5	14,5	28,5	43	36	60,5	3/4"
25x1/2	3033408	20	120	24,5	16	33	38	37	60	1/2"
25x3/4	3033409	15	120	24,5	16	35	43	37,5	60	3/4"
32x1	3033410	10	70	31,5	16	43	53,5	43	70	1"

Male Threaded Tee

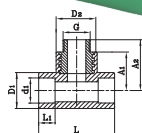

DN	Sap Code	Bag	Box	d1 (mm)	L1(min) (mm)	D1 (mm)	D2 (mm)	A1 (mm)	A2 (mm)	L (mm)	G (mm)
20x1/2	3033411	15	150	19,5	14,5	27	38,5	35	47,5	51,5	1/2"
20x3/4	3033412	10	130	19,5	14,5	28,5	43	36,5	49,5	60,5	3/4"
25x1/2	3033413	10	100	24,5	16	33	38	37	50,5	60	1/2"
25x3/4	3033414	10	100	24,5	16	35	43	37,5	50,5	60	3/4"
32x1	3033415	10	60	31,5	16	43	53,5	43	58	70	1"

Female Threaded Elbow

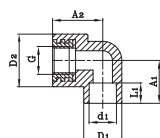

DN	Sap Code	Bag	Box	d1 (mm)	L1(min) (mm)	D1 (mm)	D2 (mm)	A1 (mm)	A2 (mm)	G (mm)
20x1/2	3033402	25	250	19,5	14,5	28,5	38,5	31,5	36	1/2"
20x3/4	3033403	20	280	19,5	14,5	29	40	31	35,5	3/4"
25x1/2	3033235	20	160	24,5	16	33,5	38,5	32	38	1/2"
25x3/4	3033404	15	180	24,5	16	33,5	43	32	40	3/4"
32x3/4	3039138	10	100	31,5	18	44	57,5	34	45	3/4"
32x1	3033405	10	100	31,5	18	43,5	54	34	45	1"



Elbow Long

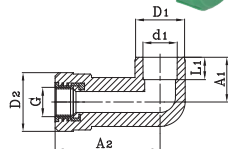

DN	Sap Code	Bag	Box	d1 (mm)	L1(min) (mm)	D1 (mm)	D2 (mm)	A1 (mm)	A2 (mm)	G (mm)
25x1/2	4049358	25	150	24,5	16	35	42	32	75	1/2"



Male Threaded Elbow

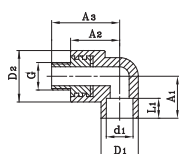

DN	Sap Code	Bag	Box	d1 (mm)	L1(min) (mm)	D1 (mm)	D2 (mm)	A1 (mm)	A2 (mm)	A3 (mm)	G (mm)
20x1/2	3033399	25	200	19,5	14,5	28,5	38,5	31,5	36	49	1/2"
20x3/4	3033011	10	180	19,5	14,5	29	40	31	36	48	3/4"
25x1/2	3033234	10	140	24,5	16	33,5	38,5	32	38	51	1/2"
25x3/4	3033400	20	160	24,5	16	33,5	43	32	40	53	3/4"
32x3/4	3051549	10	80	31,5	18	43,5	57,5	34,5	45	58	3/4"
32x1	3033013	10	80	31,5	18	43,5	54	34,5	45	62	1"

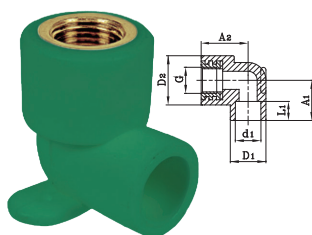

Underplaster Female Elbow

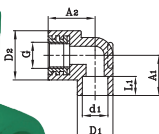

DN	Sap Code	Bag	Box	d1 (mm)	L1(min) (mm)	D1 (mm)	D2 (mm)	A1 (mm)	A2 (mm)	G (mm)
20x1/2	3039983	20	200	19,5	14,5	28	38,5	31	35	1/2"
25x1/2	3039984	15	180	24,5	16	33	38,5	31,5	36	1/2"

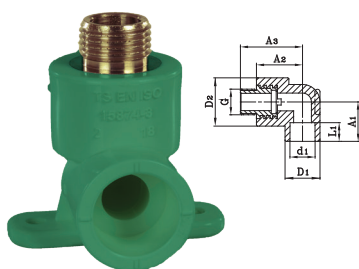

Underplaster Male Elbow

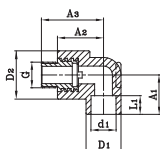

DN	Sap Code	Bag	Box	d1 (mm)	L1(min) (mm)	D1 (mm)	D2 (mm)	A1 (mm)	A2 (mm)	A3 (mm)	G (mm)
20x1/2	3039985	15	180	19,5	14,5	28	38,5	31	35	48	1/2"
25x1/2	3039986	10	180	24,5	16	33	38,5	31	36	49	1/2"



Adjustable Underplaster Female Elbow

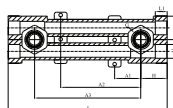

DN	Sap Code	Bag	Box	d1 (mm)	L1(min) (mm)	D1 (mm)	A1 (mm)	A2 (mm)	A3 (mm)	L (mm)	H (mm)	G (mm)
20x1/2	3033240	3	36	19,5	14,5	33	37	113	150	224	38	1/2"
25x1/2	4064555	3	36	24,5	16,5	33	37	113	150	224	38	1/2"



Double Stable Underplaster Female Elbow

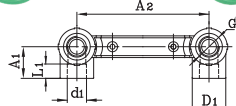

DN	Sap Code	Bag	Box	d1 (mm)	L1(min) (mm)	D1 (mm)	A1 (mm)	A2 (mm)	G (mm)
20x1/2	4047840	5	60	19,5	14,5	34	32	150	1/2"
25x1/2	4047841	5	60	24,5	16	34	32	150	1/2"

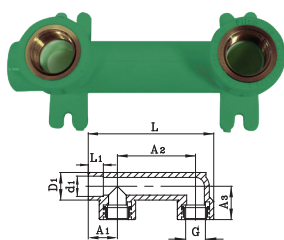

Bide Nozzle Part Female

DN	Sap Code	Bag	Box	d1 (mm)	L1(min) (mm)	D1 (mm)	A1 (mm)	A2 (mm)	A3 (mm)	L (mm)	G (mm)
20x1/2	3051585	10	60	19,5	14,5	27	28,5	90	32	136	1/2"



Valve

DN	Sap Code	Bag	Box	d1 (mm)	L1(min) (mm)	D1 (mm)	D (mm)	A (mm)	L (mm)	G (mm)
20	3078895	5	70	19,5	14,5	28	38	26	72	1/2"
25	3078898	5	70	24,5	16	33	42	30	77	3/4"
32	3078921	3	42	31,5	18	42,5	53	39	80	1"
40	3041398	3	30	39,4	20,5	54	64	43	111	1-1/4"

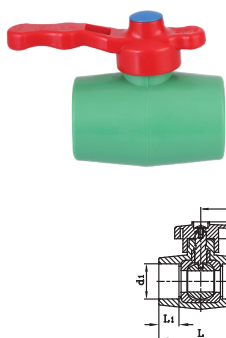

Ball Valve

DN	Sap Code	Bag	Box	d (mm)	L1(min) (mm)	A (mm)	k (mm)	L (mm)
20	3079036	5	120	19,5	14,5	50	56	68
25	3079037	5	120	24,5	16	50	56	68
32	3079038	5	80	31,5	18	54	56	75

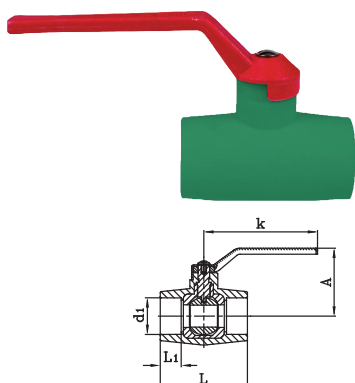

DN	Sap Code	Bag	Box	d (mm)	L1(min) (mm)	A (mm)	k (mm)	L (mm)
40	3070081	4	48	39,4	20,5	71	119	89
50	3070082	2	28	49,4	23,5	78	119	12
63	3070083	1	15	62,5	27,5	90	157	128
75	3070084	1	12	74,7	30	100	157	148



Chrome Valve

DN	Sap Code	Bag	Box	d1 (mm)	L1(min) (mm)	D1 (mm)	A (mm)	L (mm)	G (mm)
20	3072160	1	60	19,5	14,5	28,5	26,5	72	3/4"
25	3033455	1	60	24,5	16	33,5	30	77	3/4"
32	3033456	1	50	31,5	18	42,5	39	80	1"

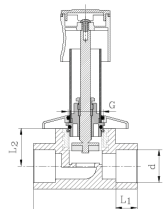

Valve Round Cap

DN	Sap Code	Bag	Box	d1 (mm)	L1(min) (mm)	D1 (mm)	A (mm)	L (mm)	G (mm)
20	3080457	1	60	19,5	14,5	28,5	26,5	72	3/4"
25	3080455	1	60	24,5	16	33,5	30	77	3/4"
32	3080456	1	50	31,5	18	43	38,5	80,5	1"

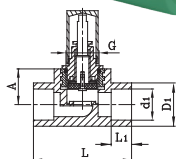

Decorative Valve

DN	Sap Code	Bag	Box	d1 (mm)	L1(min) (mm)	D1 (mm)	A (mm)	L (mm)	G (mm)
20	3072163	1	60	19,5	14,5	28,5	26,5	72	3/4"
25	3033425	1	60	24,5	16	33,5	30	77	3/4"
32	3033426	1	50	31,5	18	42,5	39	80	1"

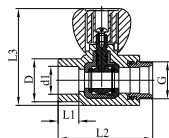

Radiator Valve Straight

DN	Sap Code	Bag	Box	d1 (mm)	L1(min) (mm)	D (mm)	L2 (mm)	L3 (mm)	G (mm)
20x3/4	4067075	5	80	19,5	14,5	30	66	68	3/4"

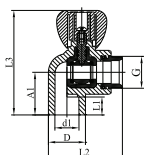

Radiator Valve Elbow

DN	Sap Code	Bag	Box	d1 (mm)	L1(min) (mm)	D (mm)	A1 (mm)	L2 (mm)	L3 (mm)	G (mm)
20x3/4	4067076	5	80	19,5	14,5	30	34,5	60	85	3/4"

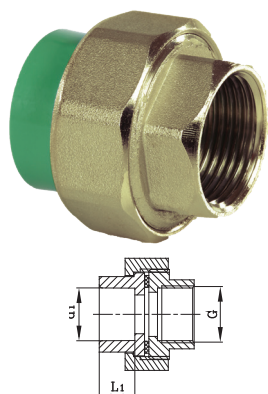

Metal Female Threaded Union (Hexagonal Shaped)

DN	Sap Code	Bag	Box	d (mm)	L1(min.) (mm)	G (mm)
20x1/2"	3033507	10	120	19,5	14,5	1/2"
25x3/4"	3033508	10	80	24,5	16	3/4"
32x3/4"	3033509	5	60	31,5	18	3/4"
32x1"	3033510	5	60	31,5	18	1"
40x1 1/4"-PN16	3033492	2	24	39,4	20,5	1-1/4"
50x1 1/2"-PN16	3033238	2	24	49,4	23,5	1-1/2"
63x2"	3033511	2	18	62,5	27,5	2"

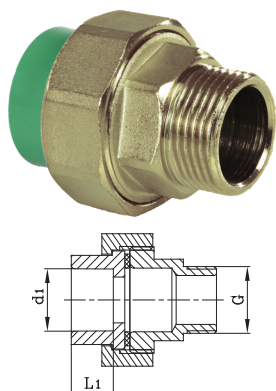

Metal Male Threaded Union (Hexagonal Shaped)

DN	Sap Code	Bag	Box	d (mm)	L1(min.) (mm)	G (mm)
20x1/2"	3033512	10	120	19,5	14,5	1/2"
25x3/4"	3033513	10	80	24,5	16	3/4"
32x3/4"	3033514	5	50	31,5	18	3/4"
32x1"	3033515	5	50	31,5	18	1"
40x1 1/4"-PN16	3033239	2	24	39,4	20,5	1-1/4"
50x1 1/2"-PN16	3033516	2	20	49,4	23,5	1-1/2"
63x2"	3033517	2	16	62,5	27,5	2"

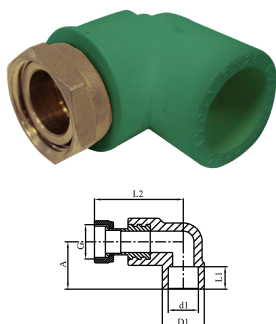

Shifting Elbow with Metal Transition

DN	Sap Code	Bag	Box	d1 (mm)	L1(min.) (mm)	D1 (mm)	A1 (mm)	L2 (mm)	G (mm)
20x1/2	3040007	30	300	19,5	14,5	28,5	30	45	1/2"
25x3/4	3040009	25	250	24,5	16	33,5	33	53	3/4"

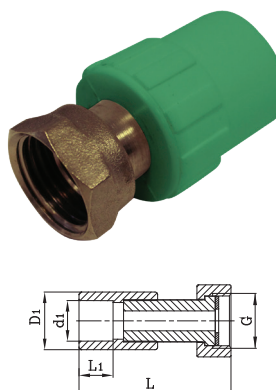

Shifting Union With Metal Transition

DN	Sap Code	Bag	Box	d1 (mm)	L1 (min.) (mm)	D1 (mm)	L (mm)	G (mm)
20x1/2	4047825	30	300	19,5	14,5	28,5	57	1/2"
20x3/4	4047826	25	250	19,5	14,5	29	59	3/4"
25x1/2	4047827	25	250	24,5	16	33,5	59	1/2"
25x3/4	4047828	25	250	24,5	16	33	59	3/4"
25x1	4065370	20	200	24,5	16	42,5	72	1"

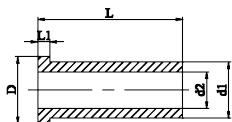
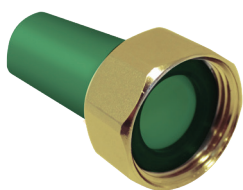

Shifting Union With Plastic Transition

DN	Sap Code	d1 (mm)	D2 (mm)	D (mm)	L (mm)	L1 (mm)
25x1	3081759	25,0	16,2	29,8	64,5	5,4

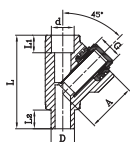

Male Filter

DN	Sap Code	Bag	Box	d1 (mm)	L1 (min) (mm)	D (mm)	D2 (mm)	L (mm)	G (mm)
20x1/2	3033518	20	200	19,5	14,5	30	41	80	1/2"
25x3/4	3033519	10	120	24,5	16	35	46	101,5	3/4"



Welding Machine Set

DN	Sap Code	Box
16-40	3033236	5
50-110	3040363	1



Welding Head

DN	Sap Code	Box
20	3033427	50
25	3033428	50
32	3033429	50
40	3033430	50
50	3033431	50
63	3033432	30
75	3033433	30
90	3033434	30
110	3033435	20
125	3033436	10



Cutter

DN	Sap Code	Box
20-25-32	3033042	30
40-63	4047816	20

Our Certificates

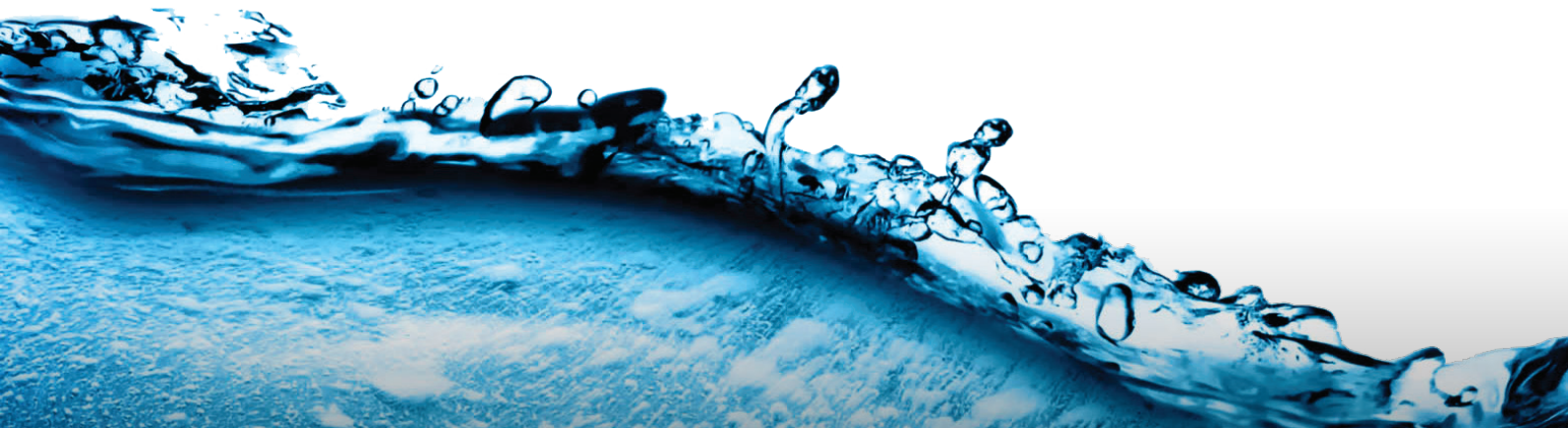

Discover our broad portfolio at www.wavin.com.tr

- Hot&Cold Water
- Indoor Climate Solutions
- Urban Climate Resillience
- Waste Water Drainage
- Water and Gas Distribution
- Foul Water

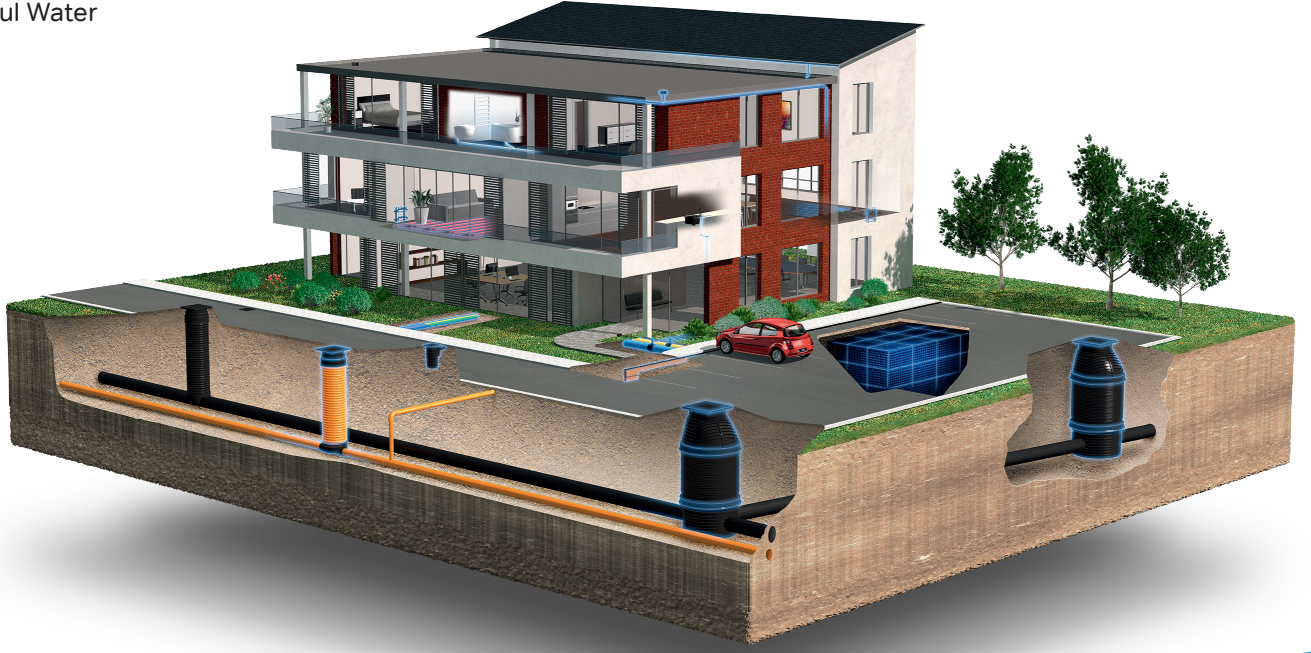

wavin

orbia 

Wavin is part of Orbia, a community of companies working together to tackle some of the world's most complex challenges.

We are bound by a common purpose:

To Advance Life Around the World.

Wavin TR Plastik Sanayi A.Ş. | Güzelevler Mah.Girne Bulvarı No: 294/A Yüreğir / Adana
Web www.wavin.com.tr | E-mail wavin.tr.info@wavin.com

Wavin operates a programme of continuous product development, and therefore reserves the right to modify or amend the specification of their products without notice. All information in this publication is given in good faith, and believed to be correct at the time of going to press. However, no responsibility can be accepted for any errors, omissions or incorrect assumptions.

© 2022 Wavin | Wavin reserves the right to make alterations without prior notice. Due to continuous product development, changes in technical specifications may change. Installation must comply with the installation instructions.